

| PART NUMBER | DESCRIPTION |
|-------------|--|
| CCS-37K | Commercial Failsafe TRANSFER, DC-40GHz |
| CS-37K | Elite Failsafe TRANSFER, DC-40GHz |

The CCS-37K/CS-37K is a long-life high performance transfer switch designed for use in 50 Ohms coaxial transmission lines operating over frequencies ranging from DC to 40GHz. The switch is designed for minimum size compatible with K connector spacing.

The failsafe switches on this page are provided with a spring operated actuator which is particularly desirable in applications where the switch is connected to one position (normally closed) most of the time and only periodically switched to the alternate position. In this type of application, holding power is required only when operating in the alternate position. Also, switching circuitry is simplified, since only one DC circuit is required.



| ENVIRONMENTAL AND PHYSICAL CHARACTERISTICS | |
|--|-------------------------|
| Operating Temperature | |
| Commercial Model, CCS-37K | -25°C to 65°C |
| Elite Model, CS-37K | -55°C to 85°C |
| Vibration (MIL-STD-202 Method 214, Condition D, non-operating) | 10 g's RMS |
| Shock (MIL-STD-202 Method 213, Condition D, non-operating) | 500 g's |
| Standard Actuator Life | 2,000,000 cycles |
| Connector Type | 2.92 mm / K |
| Weight | 3.0 oz. (70.87g) (max.) |

| ELECTRICAL CHARACTERISTICS | |
|-----------------------------------|-----------------------------|
| Form Factor | TRANSFER, break before make |
| Frequency Range | |
| CCS-37K | DC-40 GHz |
| CS-37K | DC-40 GHz |
| Characteristic Impedance | 50 Ohms |
| Operate Time | 20 ms (max.) |
| Release Time | 10 ms (max.) |
| Actuation Voltage Available | 12 15 24 28 V |
| Actuation Current, max. @ ambient | 800 650 700 400 mA |

| TYPICAL PERFORMANCE CHARACTERISTICS | | | | | | |
|-------------------------------------|----------|----------|-----------|----------|-----------|-----------|
| Frequency | DC-6 GHz | 6-12 GHz | 12-18 GHz | 18-30GHz | 30-33 GHz | 33-40 GHz |
| Insertion Loss, dB, typical. | 0.15 | 0.25 | 0.35 | 0.55 | 1.00 | 1.35 |
| Isolation, dB, typical. | 70 | 70 | 65 | 60 | 50 | 50 |
| VSWR , typical. | 1.15:1 | 1.20:1 | 1.25:1 | 1.50:1 | 2.00:1 | 2.50:1 |

PART NUMBERING SYSTEM

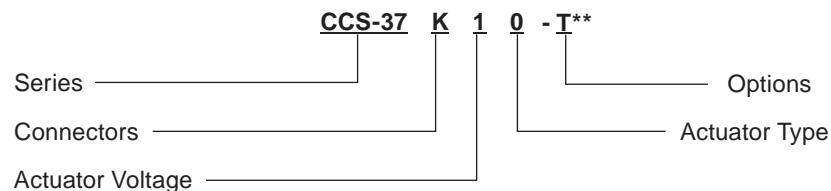

Connector
K: 2.92 mm Female

Actuator Voltage
1: 28 Vdc Failsafe
2: 15 Vdc Failsafe
3: 12 Vdc Failsafe
4: 24 Vdc Failsafe

Actuator Type
0: Standard Contacts
C: Indicator Contacts

Options
T: TTL Drivers with Diodes
D: Transient Suppression Diodes
M: Moisture Seal
S: 9 Pin D-Sub Connector

For other options, contact factory.

Series CCS-37K/CS-37K
 DC-40 GHz
 Failsafe TRANSFER Coaxial Switch



SCHEMATICS AND MECHANICAL OUTLINE

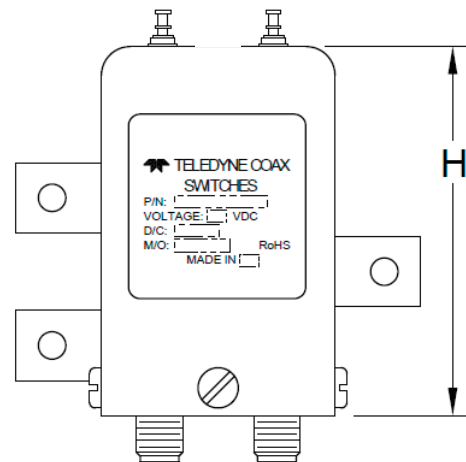
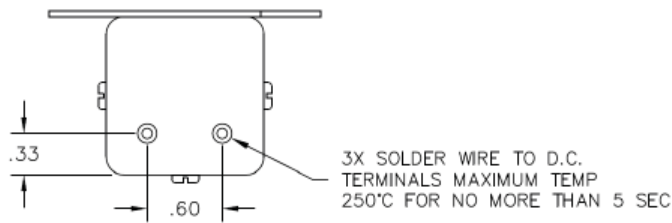
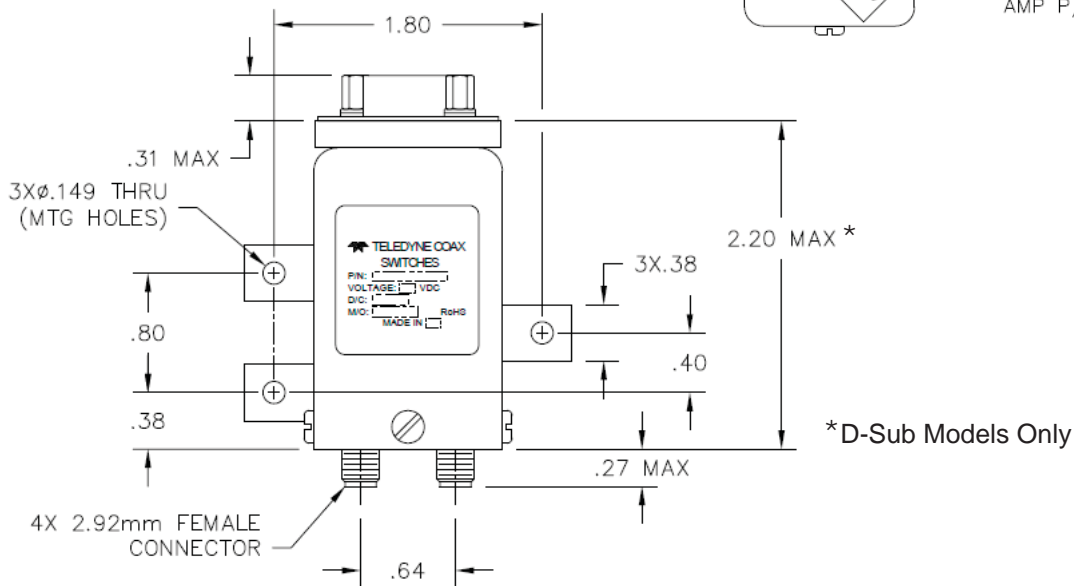
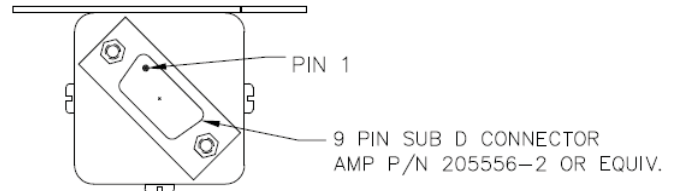
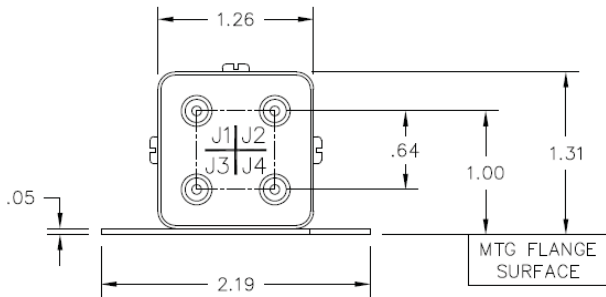

H=2.00 Max STD & Indicators Models
 H=2.10 Max TTL Models

SCHEMATICS AND MECHANICAL OUTLINE

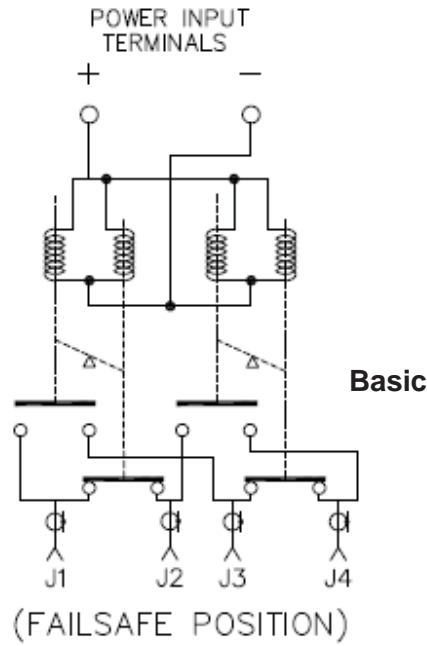

| VOLTAGE | RF CONTINUITY |
|--------------|---------------|
| DE-ENERGIZED | J1-J2 & J3-J4 |
| ENERGIZED | J1-J3 & J2-J4 |

| 9 PIN D-SUB PINOUT FOR FAILSAFE TRANSFER | | | | |
|--|---------|------------|--------|------------------|
| Pin No. | OPTIONS | | | |
| | Basic | Indicators | TTL | Indicators & TTL |
| 1 | + | + | | |
| 2 | - | - | | |
| 3 | | | Common | Common |
| 4 | | | 1 | 1 |
| 5 | | | | |
| 6 | | | Vsw | Vsw |
| 7 | | A | | A |
| 8 | | B | | B |
| 9 | | C | | C |

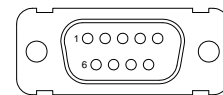

“-S OPTION” 9-PIN D-SUB CONNECTOR (EXAMPLE: CCS-37K10-S)

TYPICAL RF PERFORMANCE CURVES

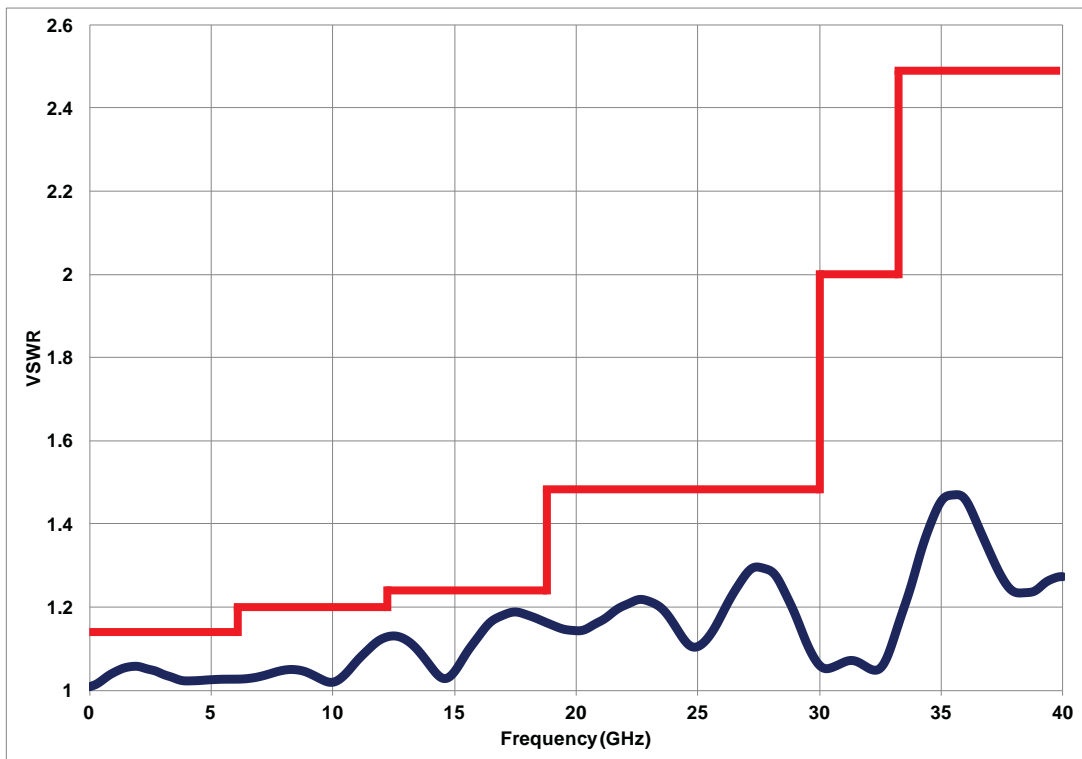
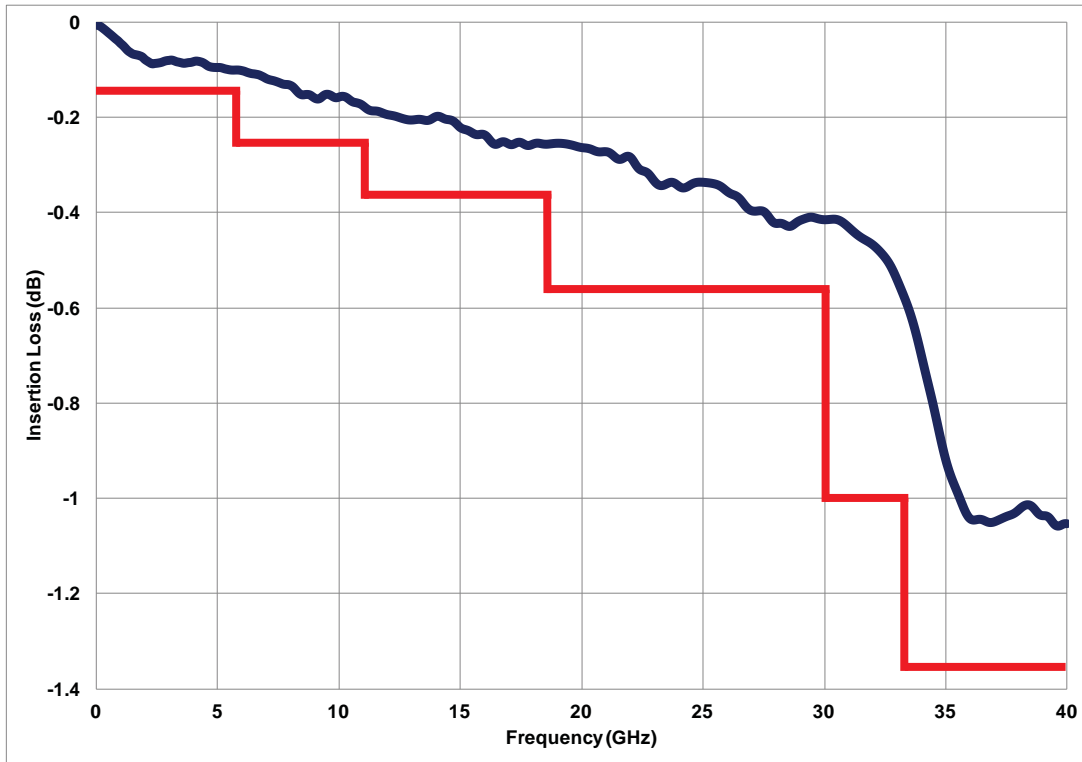

TYPICAL RF PERFORMANCE CURVES

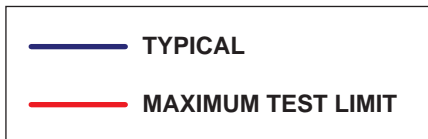
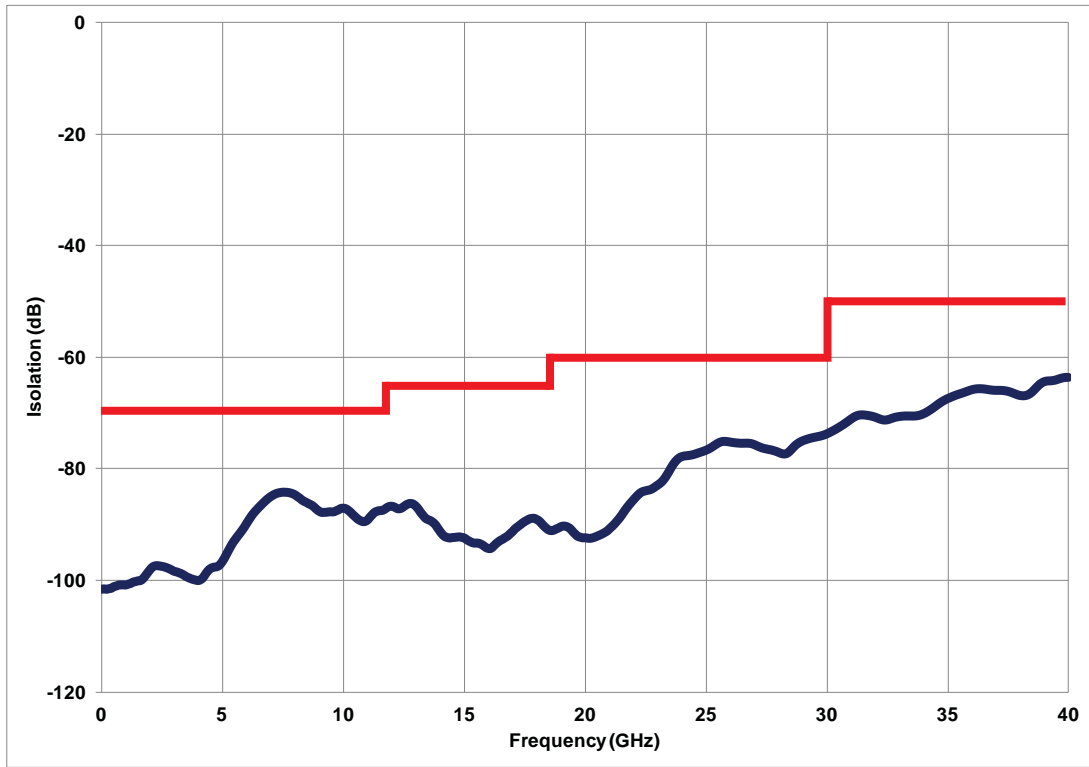

TYPICAL POWER PERFORMANCE CURVE

Power Handling vs. Frequency

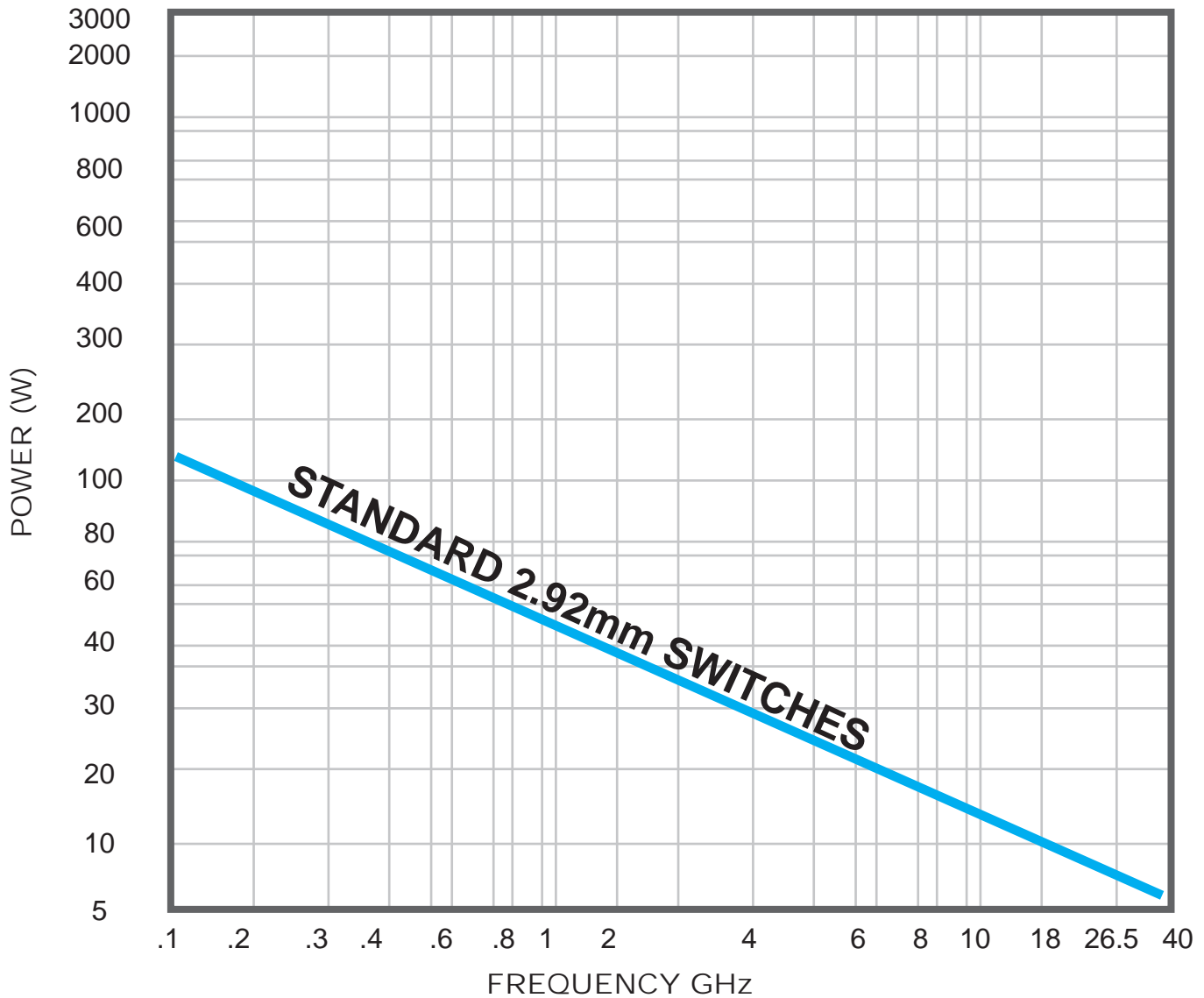

Estimates based on the following reference conditions:

- Ambient temperature of 40°C or less
- Sea level operation
- Load VSWR of 1.20:1 maximum
- No high-power (hot) switching

Please contact Teledyne Coax Switches for derating factors when applications do not meet the foregoing reference conditions.

GLOSSARY

Actuator

An actuator is the electromechanical mechanism that transfers the RF contacts from one position to another upon DC command.

Arc Suppression Diode

A diode is connected in parallel with the coil. This diode limits the “reverse EMF spike” generated when the coil de-energizes to 0.7 volts. The diode cathode is connected to the positive side of the coil and the anode is connected to the negative side.

Date Code

All switches are marked with either a unique serial number or a date code. Date codes are in accordance with MIL-STD-1285 Paragraph 5.2.5 and consist of four digits. The first two digits define the year and the last two digits define the week of the year (YYWW). Thus, 1032 identifies switches that passed through final inspection during the 32nd week of 2010.

Failsafe

A failsafe switch reverts to the default or failsafe position when actuating voltage is removed. This is realized by a return spring within the drive mechanism. This type of switch requires the continuous application of operating voltage to select and hold any position.

Indicator

Indicators tell the system which position the switch is in. Other names for indicators are telemetry contacts or tellback circuit. Indicators are usually a set of internally mounted DC contacts linked to the actuator. They can be wired to digital input lines, status lights, or interlocks. Unless otherwise specified, the maximum indicator contact rating is 30 Vdc, 50 mA, or 1.5 Watts into a resistive load.

Isolation

Isolation is the measure of the power level at the output connector of an unconnected RF channel as referenced to the power at the input connector. It is specified in dB below the input power level.

TRANSFER Switch

A four-port switch consisting of two independent pairs of RF paths. These pairs are actuated simultaneously. This actuation is similar to that of a double-pole double-throw switch.

Switching Time

Switching time is the total interval beginning with the arrival of the leading edge of the command pulse at the switch DC input and ending with the completion of the switch transfer, including contact bounce. It consists of three parts: (1) inductive delay in the coil, (2) transfer time of the physical movement of the contacts, and (3) the bounce time of the RF contacts.

Performance Parameters vs Frequency

Generally speaking, the RF performance of coaxial switches is frequency dependent. With increasing frequency, VSWR and insertion loss increase while isolation decreases. All data sheets specify these three parameters as “worst case” at the highest operating frequency. If the switch is to be used over a narrow frequency band, better performance can be achieved.

TTL Switch Driver Option

As a special option, switch drivers can be provided for both failsafe and latching switches, which are compatible with industry-standard low-power Schottky TTL circuits.

Actuator Current vs Temperature

The resistance of the actuator coil varies as a function of temperature. There is an inverse relationship between the operating temperature of the switch and the actuator drive current. For switches operating at 28 VDC, the approximate actuator drive current at temperature, T, can be calculated using the equation:

$$I_T = \frac{I_A}{[1 + .00385 (T-20)]}$$

Where:

I_T = Actuator current at temperature, T

I_A = Room temperature actuator current – see data sheet

T = Temperature of interest in °C

Magnetic Sensitivity

An electro-mechanical switch can be sensitive to ferrous materials and external magnetic fields. Neighboring ferrous materials should be permitted no closer than 0.5 inches and adjacent external magnetic fields should be limited to a flux density of less than 5 Gauss.