



PART NUMBER	DESCRIPTION
CCR-38S	Commercial Normally Open Multi-throw, DC-12 GHz
CR-38S	Elite Normally Open Multi-throw, DC-12 GHz

The CCR-38S/CR-38S is a broadband, multi-throw, electromechanical coaxial switch designed to switch a microwave signal from a common input to any of 9 or 10 outputs. The characteristic impedance is 50 Ohms. The switches are small using the popular connector spacing on a 1.740" dia. circle. Each position has an individual actuator mechanism allowing random position selection. This also gives the minimum switching time.

With the normally open actuator, all paths are open when the switch is de-energized.



ENVIRONMENTAL AND PHYSICAL CHARACTERISTICS	
Operating Temperature	
Commercial Model, CCR-38S	-25°C to 65°C
Elite Model, CR-38S	-40°C to 85°C
Vibration (MIL-STD-202 Method 214, Condition D, non-operating)	10 g's RMS
Shock (MIL-STD-202 Method 213, Condition D, non-operating)	500 g's
Standard Actuator Life	3,000,000 cycles
Actuator Life w/ Additional Features	1,000,000 cycles
Connector Type	SMA
Humidity (Moisture Seal)	Available
Weight	9 oz. (255.2G) (max.)

ELECTRICAL CHARACTERISTICS	
Form Factor	Multi-Throw, break before make
Frequency Range	DC–12 GHz
Characteristic Impedance	50 Ohms
Operate Time	20 ms (max.)
Release Time	20 ms (max.)
Actuation Voltage Available	12 15 24 28 V
Actuation Current, max. @ ambient	580 720 345 405 mA

TYPICAL PERFORMANCE CHARACTERISTICS				
Frequency	DC–2 GHz	2–4 GHz	4–8 GHz	8–10 GHz
Insertion Loss, dB, max.	0.20	0.30	.40	.50
Isolation, dB, min.	80	75	70	65
VSWR , max.	1.2:1	1.30:1	1.40:1	1.50:1

For maximum limits, please see charts on pages 7

PART NUMBERING SYSTEM

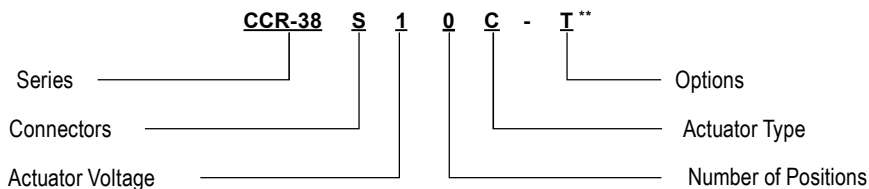

CONNECTOR	ACTUATOR VOLTAGE	NUMBER OF POSITIONS	ACTUATOR TYPE	OPTIONS
S: SMA FEMALE	1: 28 VDC NORMALLY OPEN	9: SP9T	0: NO INDICATOR CONTACTS	T: TTL DRIVERS WITH DIODES
	2: 15 VDC NORMALLY OPEN	0: SP10T	C: INDICATOR CONTACTS***	D: COIL TRANSIENT SUPPRESSION DIODES
	3: 12 VDC NORMALLY OPEN			S: D-SUB CONNECTOR*
	4: 24 VDC NORMALLY OPEN			TD: DECODERS AND TTL DRIVERS WITH DIODES
				M: MOISTURE SEAL

**SEE PARTS LIST ON PAGE 10

For additional options, please contact factory.

* D-Sub Connector may be 15 or 25 pin depending on number of throws. (See Connector Pinout page)

Series CCR-38S/CR-38S
 Multi-Throw DC-10 GHz, SP9T & SP10T
 Normally Open Coaxial Switch



SCHEMATICS AND MECHANICAL OUTLINE

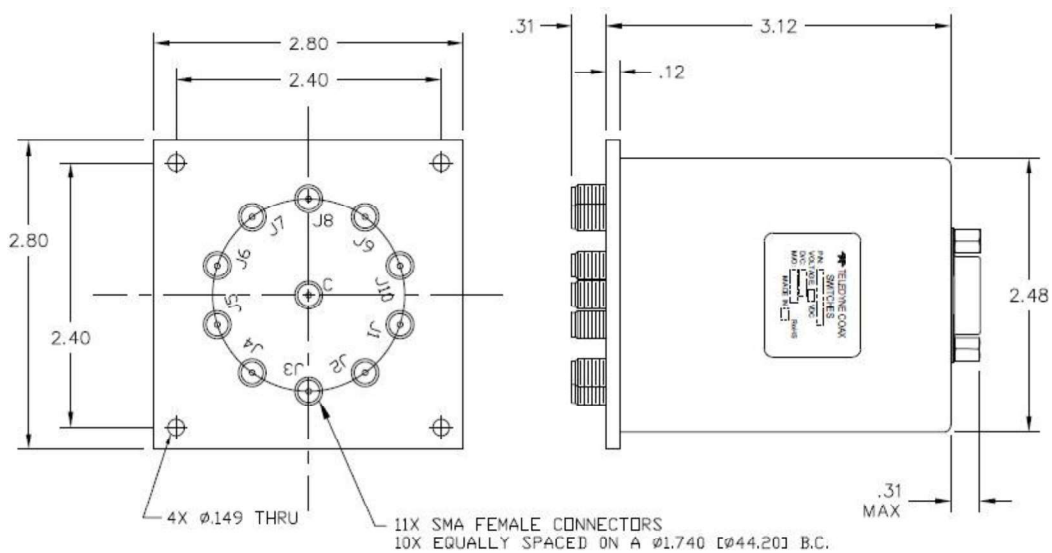
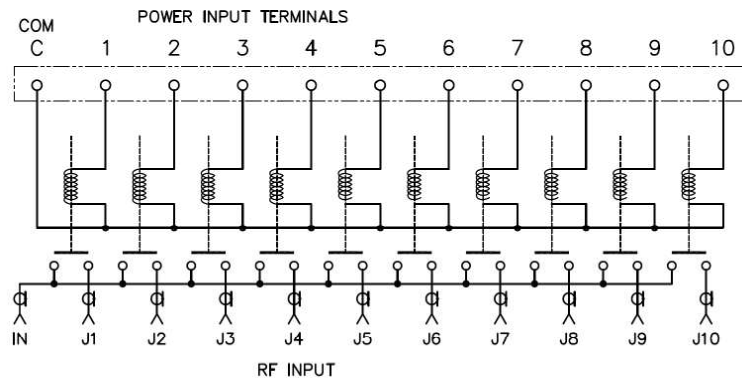

“-TS OR -TDS OPTIONS” 15-PIN D-SUB OR 25-PIN D-SUB CONNECTOR (EXAMPLE: CCR-38S180-TS OR CCR-38S180-TDS)

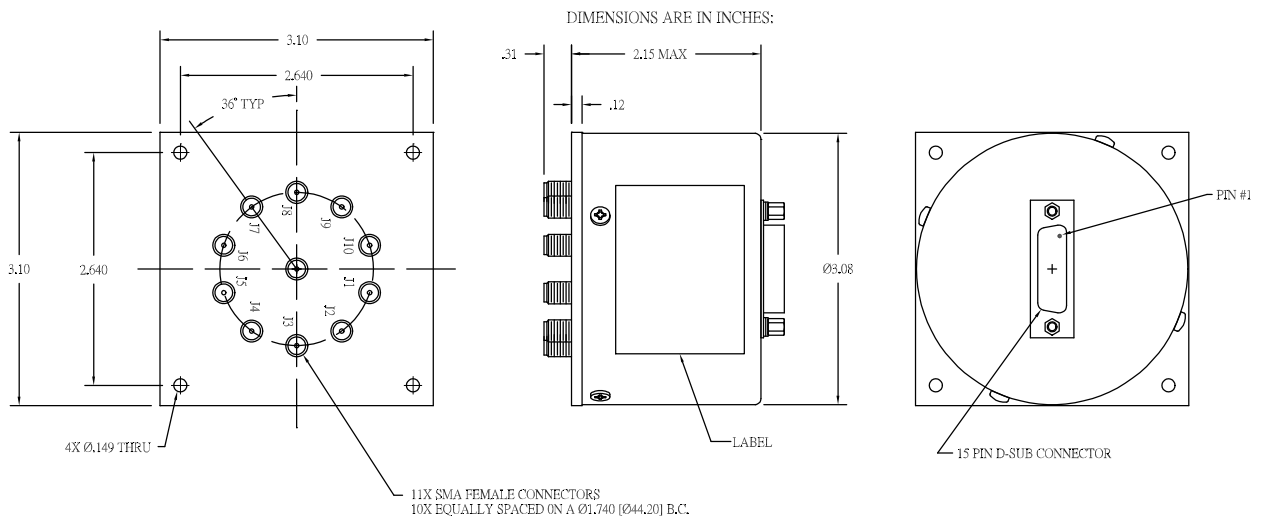

“-S OPTION” 15-PIN D-SUB OR 25-PIN D-SUB CONNECTOR (EXAMPLE: CCR-38S180-S)

CONNECTOR PINOUT FOR NORMALLY OPEN SP9T MULTI-THROW SWITCHES						
EXAMPLE	CR-38S190-S	CR-38S19C-S	CR-38S190-TS	CR-38S19C-TS	CR-38S190-TDS	CR-38S19C-TDS
PIN NO	15-PINS	25-PINS	15-PINS	25-PINS	15-PINS	25-PINS
INDICATOR		YES		YES		YES
TTL			YES	YES		
DECODERS & TTL					YES	YES
1	PORT 1	PORT 1	TTL 1	TTL 1	LOGIC 1	LOGIC 1
2	PORT 2	PORT 3	TTL 2	TTL 2	LOGIC 2	LOGIC 2
3	PORT 3	PORT 3	TTL 3	TTL 3	LOGIC 3	LOGIC 3
4	PORT 4	PORT 4	TTL 4	TTL 4	LOGIC 4	LOGIC 4
5	PORT 5	PORT 5	TTL 5	TTL 5		
6	PORT 6	PORT 6	TTL 6	TTL 6		
7	PORT 7	PORT 7	TTL 7	TTL 7		
8	PORT 8	PORT 8	TTL 8	TTL 8		
9	PORT 9	PORT 9	TTL 9	TTL 9		
10						
11			Vsw	Vsw	Vsw	Vsw
12						
13	COMMON	COMMON	COMMON	COMMON	COMMON	COMMON
14						
15		D INDICATOR (COM)		D INDICATOR (COM)		D INDICATOR (COM)
16		E INDICATOR		E INDICATOR		E INDICATOR
17		F INDICATOR		F INDICATOR		F INDICATOR
18		G INDICATOR		G INDICATOR		G INDICATOR
19		H INDICATOR		H INDICATOR		H INDICATOR
20		K INDICATOR		K INDICATOR		K INDICATOR
21		L INDICATOR		L INDICATOR		L INDICATOR
22		M INDICATOR		M INDICATOR		M INDICATOR
23		N INDICATOR		N INDICATOR		N INDICATOR
24		P INDICATOR		P INDICATOR		P INDICATOR
25						

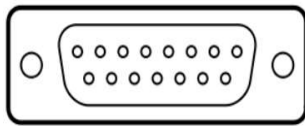

15-PIN D-SUB CONNECTOR

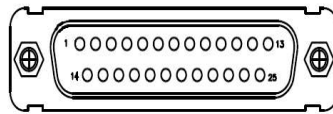

25-PIN D-SUB CONNECTOR

Series CCR-38S/CR-38S
Multi-Throw DC-10 GHz, SP9T & SP10T
Normally Open Coaxial Switch



SP9T TRUTH TABLE Normally Open
CCR-38SX9C-T

Logic Input									RF Path									Indicator Switches								
1	2	3	4	5	6	7	8	9	J1	J2	J3	J4	J5	J6	J7	J8	J9	E	F	G	H	K	L	M	N	P
1	0	0	0	0	0	0	0	0	On	Off	Off	Off	Off	Off	Off	Off	Off	C	0	0	0	0	0	0	0	0
0	1	0	0	0	0	0	0	0	Off	On	Off	Off	Off	Off	Off	Off	Off	0	C	0	0	0	0	0	0	0
0	0	1	0	0	0	0	0	0	Off	Off	On	Off	Off	Off	Off	Off	Off	0	0	C	0	0	0	0	0	0
0	0	0	1	0	0	0	0	0	Off	Off	Off	On	Off	Off	Off	Off	Off	0	0	0	C	0	0	0	0	0
0	0	0	0	1	0	0	0	0	Off	Off	Off	Off	On	Off	Off	Off	Off	0	0	0	0	C	0	0	0	0
0	0	0	0	0	1	0	0	0	Off	Off	Off	Off	Off	On	Off	Off	Off	0	0	0	0	0	C	0	0	0
0	0	0	0	0	0	1	0	0	Off	Off	Off	Off	Off	Off	On	Off	Off	0	0	0	0	0	0	C	0	0
0	0	0	0	0	0	0	1	0	Off	Off	Off	Off	Off	Off	Off	On	Off	0	0	0	0	0	0	0	C	0
0	0	0	0	0	0	0	0	1	Off	Off	Off	Off	Off	Off	Off	Off	On	0	0	0	0	0	0	0	0	C

TRUTH TABLE Normally Open
CCR-38SX9C-TD

Logic Input				RF Path									Indicator Switches								
1	2	3	4	J1	J2	J3	J4	J5	J6	J7	J8	J9	E	F	G	H	K	L	M	N	P
0	0	0	0	On	Off	Off	Off	Off	Off	Off	Off	Off	C	0	0	0	0	0	0	0	0
1	0	0	0	Off	On	Off	Off	Off	Off	Off	Off	Off	0	C	0	0	0	0	0	0	0
0	1	0	0	Off	Off	On	Off	Off	Off	Off	Off	Off	0	0	C	0	0	0	0	0	0
1	1	0	0	Off	Off	Off	On	Off	Off	Off	Off	Off	0	0	0	C	0	0	0	0	0
0	0	1	0	Off	Off	Off	Off	On	Off	Off	Off	Off	0	0	0	0	C	0	0	0	0
1	0	1	0	Off	Off	Off	Off	Off	On	Off	Off	Off	0	0	0	0	0	C	0	0	0
0	1	1	0	Off	Off	Off	Off	Off	Off	On	Off	Off	0	0	0	0	0	0	C	0	0
1	1	1	0	Off	Off	Off	Off	Off	Off	Off	On	Off	0	0	0	0	0	0	0	C	0
0	0	0	1	Off	Off	Off	Off	Off	Off	Off	Off	On	0	0	0	0	0	0	0	0	C
1	1	1	1	Off	Off	Off	Off	Off	Off	Off	Off	Off	0	0	0	0	0	0	0	0	0

CONNECTOR PINOUT FOR NORMALLY OPEN SP10T MULTI-THROW SWITCHES						
EXAMPLE	CR-38S100-S	CR-38S10C-S	CR-38S100-TS	CR-38S10C-TS	CR-38S100-TDS	CR-38S10C-TDS
PIN NO	15-PINS	25-PINS	15-PINS	25-PINS	15-PINS	25-PINS
INDICATOR		YES		YES		YES
TTL			YES	YES		
DECODERS & TTL					YES	YES
1	PORT 1	PORT 1	TTL 1	TTL 1	LOGIC 1	LOGIC 1
2	PORT 2	PORT 3	TTL 2	TTL 2	LOGIC 2	LOGIC 2
3	PORT 3	PORT 3	TTL 3	TTL 3	LOGIC 3	LOGIC 3
4	PORT 4	PORT 4	TTL 4	TTL 4	LOGIC 4	LOGIC 4
5	PORT 5	PORT 5	TTL 5	TTL 5		
6	PORT 6	PORT 6	TTL 6	TTL 6		
7	PORT 7	PORT 7	TTL 7	TTL 7		
8	PORT 8	PORT 8	TTL 8	TTL 8		
9	PORT 9	PORT 9	TTL 9	TTL 9		
10	PORT 10	PORT 10	TTL 10	TTL 10		
11			Vsw	Vsw	Vsw	Vsw
12						
13	COMMON	COMMON	COMMON	COMMON	COMMON	COMMON
14						
15		D INDICATOR (COM)		D INDICATOR (COM)		D INDICATOR (COM)
16		E INDICATOR		E INDICATOR		E INDICATOR
17		F INDICATOR		F INDICATOR		F INDICATOR
18		G INDICATOR		G INDICATOR		G INDICATOR
19		H INDICATOR		H INDICATOR		H INDICATOR
20		K INDICATOR		K INDICATOR		K INDICATOR
21		L INDICATOR		L INDICATOR		L INDICATOR
22		M INDICATOR		M INDICATOR		M INDICATOR
23		N INDICATOR		N INDICATOR		N INDICATOR
24		P INDICATOR		P INDICATOR		P INDICATOR
25		T INDICATOR		T INDICATOR		T INDICATOR

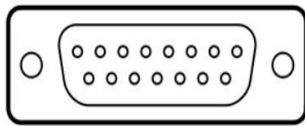

15-PIN D-SUB CONNECTOR

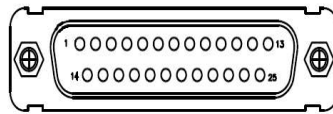

25-PIN D-SUB CONNECTOR

Series CCR-38S/CR-38S
Multi-Throw DC-10 GHz, SP9T & SP10T
Normally Open Coaxial Switch



SP10T TRUTH TABLE Normally Open
CCR-38SX0C-T

Logic Input										RF Path										Indicator Switches										
1	2	3	4	5	6	7	8	9	10	J1	J2	J3	J4	J5	J6	J7	J8	J9	J10	E	F	G	H	K	L	M	N	P	T	
1	0	0	0	0	0	0	0	0	0	On	Off	Off	Off	Off	Off	Off	Off	Off	Off	C	0	0	0	0	0	0	0	0	0	
0	1	0	0	0	0	0	0	0	0	Off	On	Off	Off	Off	Off	Off	Off	Off	Off	0	C	0	0	0	0	0	0	0	0	
0	0	1	0	0	0	0	0	0	0	Off	Off	On	Off	Off	Off	Off	Off	Off	Off	0	0	C	0	0	0	0	0	0	0	
0	0	0	1	0	0	0	0	0	0	Off	Off	Off	On	Off	Off	Off	Off	Off	Off	0	0	0	C	0	0	0	0	0	0	
0	0	0	0	1	0	0	0	0	0	Off	Off	Off	Off	On	Off	Off	Off	Off	Off	0	0	0	0	C	0	0	0	0	0	
0	0	0	0	0	1	0	0	0	0	Off	Off	Off	Off	Off	On	Off	Off	Off	Off	0	0	0	0	0	C	0	0	0	0	
0	0	0	0	0	0	1	0	0	0	Off	Off	Off	Off	Off	Off	On	Off	Off	Off	0	0	0	0	0	0	C	0	0	0	
0	0	0	0	0	0	0	1	0	0	Off	Off	Off	Off	Off	Off	Off	On	Off	Off	0	0	0	0	0	0	0	C	0	0	
0	0	0	0	0	0	0	0	1	0	Off	Off	Off	Off	Off	Off	Off	Off	On	Off	0	0	0	0	0	0	0	0	C	0	
0	0	0	0	0	0	0	0	0	1	Off	Off	Off	Off	Off	Off	Off	Off	Off	On	0	0	0	0	0	0	0	0	0	C	0
0	0	0	0	0	0	0	0	0	1	Off	Off	Off	Off	Off	Off	Off	Off	Off	Off	0	0	0	0	0	0	0	0	0	0	C

TRUTH TABLE Normally Open
CCR-38SX0C-TD

Logic Input				RF Path										Indicator Switches									
1	2	3	4	J1	J2	J3	J4	J5	J6	J7	J8	J9	J10	E	F	G	H	K	L	M	N	P	T
0	0	0	0	On	Off	Off	Off	Off	Off	Off	Off	Off	Off	C	0	0	0	0	0	0	0	0	0
1	0	0	0	Off	On	Off	Off	Off	Off	Off	Off	Off	Off	0	C	0	0	0	0	0	0	0	0
0	1	0	0	Off	Off	On	Off	Off	Off	Off	Off	Off	Off	0	0	C	0	0	0	0	0	0	0
1	1	0	0	Off	Off	Off	On	Off	Off	Off	Off	Off	Off	0	0	0	C	0	0	0	0	0	0
0	0	1	0	Off	Off	Off	Off	On	Off	Off	Off	Off	Off	0	0	0	0	C	0	0	0	0	0
1	0	1	0	Off	Off	Off	Off	Off	On	Off	Off	Off	Off	0	0	0	0	0	C	0	0	0	0
0	1	1	0	Off	Off	Off	Off	Off	Off	On	Off	Off	Off	0	0	0	0	0	0	C	0	0	0
1	1	1	0	Off	Off	Off	Off	Off	Off	Off	On	Off	Off	0	0	0	0	0	0	0	C	0	0
0	0	0	1	Off	Off	Off	Off	Off	Off	Off	Off	On	Off	0	0	0	0	0	0	0	0	C	0
1	0	0	1	Off	Off	Off	Off	Off	Off	Off	Off	Off	On	0	0	0	0	0	0	0	0	0	C
1	1	1	1	Off	Off	Off	Off	Off	Off	Off	Off	Off	Off	0	0	0	0	0	0	0	0	0	0

TYPICAL RF PERFORMANCE CURVES

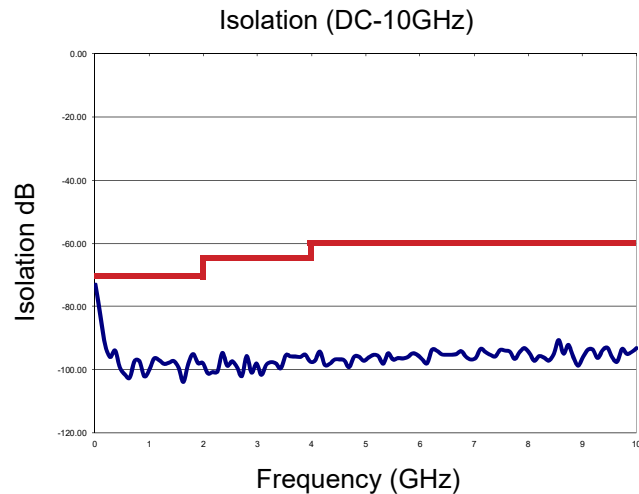
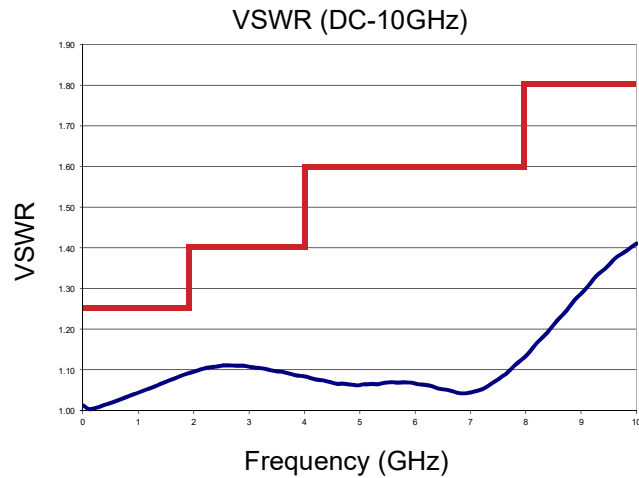
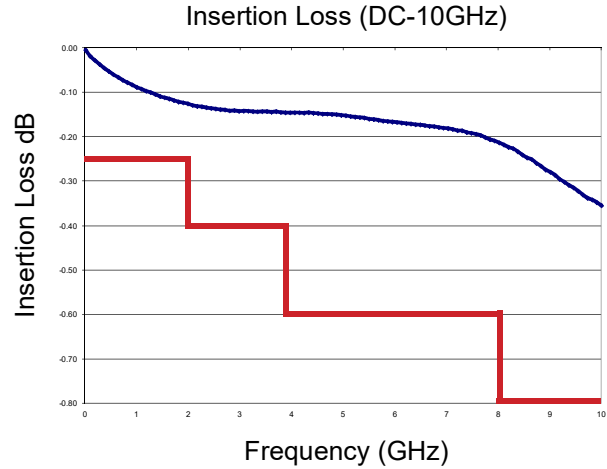

TYPICAL POWER PERFORMANCE CURVE

Power Handling vs. Frequency

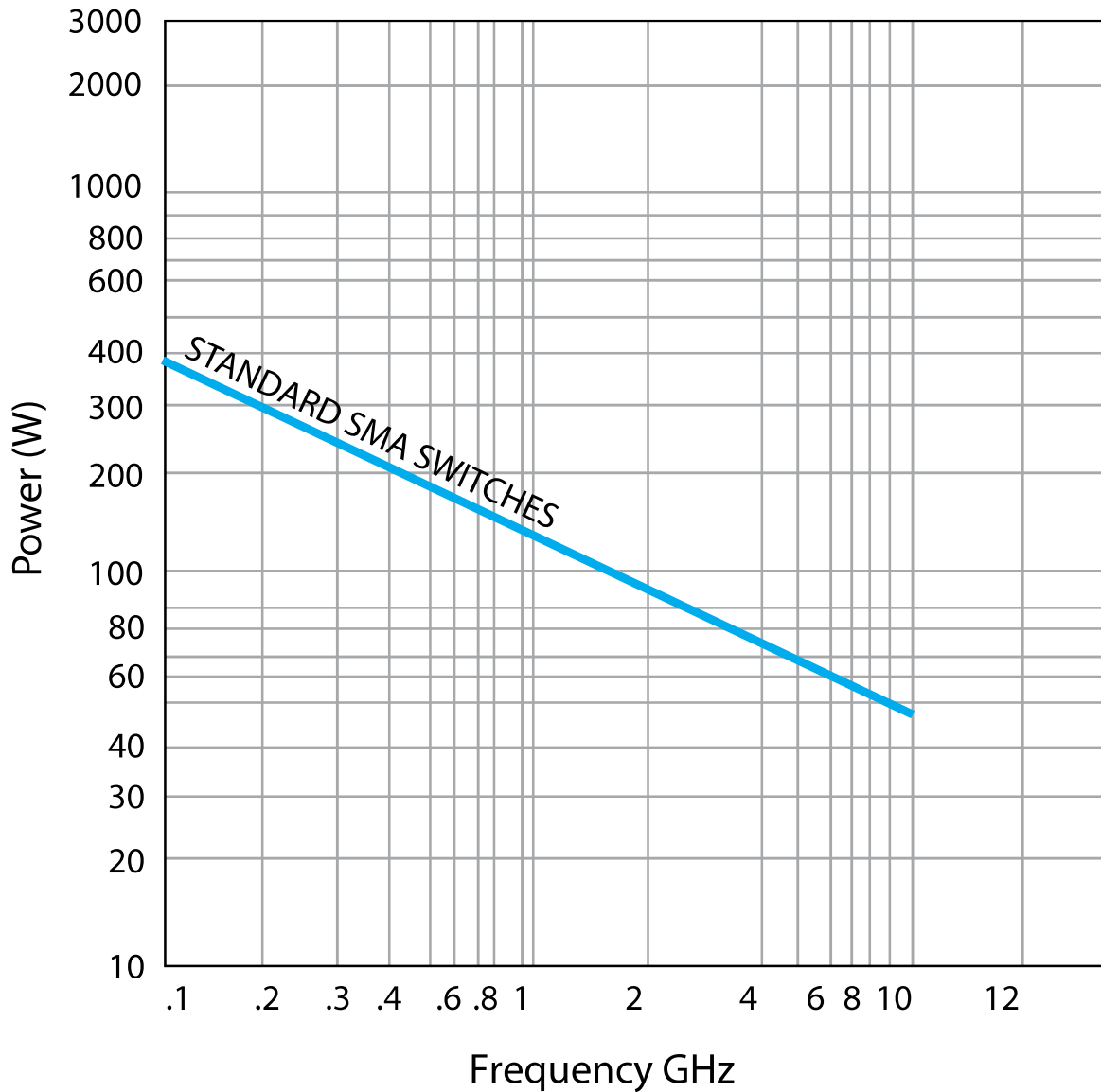

Estimates based on the following reference conditions:

- Ambient temperature of 40°C or less
- Sea level operation
- Load VSWR of 1.20:1 maximum
- No high-power (hot) switching

Please contact Teledyne Coax Switches for derating factors when applications do not meet the foregoing reference conditions.

GLOSSARY

Actuator

An actuator is the electromechanical mechanism that transfers the RF contacts from one position to another upon DC command.

Arc Suppression Diode

A diode is connected in parallel with the coil. This diode limits the “reverse EMF spike” generated when the coil de-energizes to 0.7 volts. The diode cathode is connected to the positive side of the coil and the anode is connected to the negative side.

Date Code

All switches are marked with either a unique serial number or a date code. Date codes are in accordance with MIL-STD-1285 Paragraph 5.2.5 and consist of four digits. The first two digits define the year and the last two digits define the week of the year (YYWW). Thus, 1032 identifies switches that passed through final inspection during the 32nd week of 2010.

Indicator

Indicators tell the system which position the switch is in. Other names for indicators are telemetry contacts or tellback circuit. Indicators are usually a set of internally mounted DC contacts linked to the actuator. They can be wired to digital input lines, status lights, or interlocks. Unless otherwise specified, the maximum indicator contact rating is 30 Vdc, 50 mA, or 1.5 Watts into a resistive load.

Isolation

Isolation is the measure of the power level at the output connector of an unconnected RF channel as referenced to the power at the input connector. It is specified in dB below the input power level.

Multi-Throw Switch

A multi-throw switch is a switch with one input and three or more output ports. The CCR-38 can switch a microwave signal to any of 10 outputs from a single common input.

Switching Time

Switching time is the total interval beginning with the arrival of the leading edge of the command pulse at the switch DC input and ending with the completion of the switch transfer, including contact bounce. It consists of three parts: (1) inductive delay in the coil, (2) transfer time of the physical movement of the contacts, and (3) the bounce time of the RF contacts.

TTL Switch Driver Option

As a special option, switch drivers can be provided for both failsafe and latching switches, which are compatible with industry-standard low-power Schottky TTL circuits.

TD-Option

This option includes a decoder. The 3-bit parallel command is decoded to internally select the appropriate position. See the logic tables. The TD-Option increases the Vsw supply current demand by 50mA max at 28Vdc and +20°C.

Performance Parameters vs Frequency

Generally speaking, the RF performance of coaxial switches is frequency dependent. With increasing frequency, VSWR and insertion loss increase while isolation decreases. All data sheets specify these three parameters as “worst case” at the highest operating frequency. If the switch is to be used over a narrow frequency band, better performance can be achieved.

Actuator Current vs Temperature

The resistance of the actuator coil varies as a function of temperature. There is an inverse relationship between the operating temperature of the switch and the actuator drive current. For switches operating at 28 VDC, the approximate actuator drive current at temperature, T, can be calculated using the equation:

$$I_T = \frac{I_A}{[1 + .00385 (T-20)]}$$

Where:

I_T = Actuator current at temperature, T

I_A = Room temperature actuator current – see data sheet

T = Temperature of interest in °C

Magnetic Sensitivity

An electro-mechanical switch can be sensitive to ferrous materials and external magnetic fields. Neighboring ferrous materials should be permitted no closer than 0.5 inches and adjacent external magnetic fields should be limited to a flux density of less than 5 Gauss.

Series CCR-38S/CR-38S
 Multi-Throw DC–10 GHz, SP9T & SP10T
 Normally Open Coaxial Switch



NORMALLY OPEN CCR-38S PART NUMBER LIST

	PART No.		PART No.		PART No.
1	CCR-38SX9C	43	CCR-38SX90	85	CCR-38SX0C
2	CCR-38SX9C-D	44	CCR-38SX90-D	86	CCR-38SX0C-D
3	CCR-38SX9C-DM	45	CCR-38SX90-DM	87	CCR-38SX0C-DM
4	CCR-38SX9C-M	46	CCR-38SX90-M	88	CCR-38SX0C-M
5	CCR-38SX9C-MS	47	CCR-38SX90-MS	89	CCR-38SX0C-MS
6	CCR-38SX9C-S	48	CCR-38SX90-S	90	CCR-38SX0C-S
7	CCR-38SX9C-T	49	CCR-38SX90-T	91	CCR-38SX0C-T
8	CCR-38SX9C-TD	50	CCR-38SX90-TD	92	CCR-38SX0C-TD
9	CCR-38SX9C-TDM	51	CCR-38SX90-TDM	93	CCR-38SX0C-TDM
10	CCR-38SX9C-TDMS	52	CCR-38SX90-TDMS	94	CCR-38SX0C-TDMS
11	CCR-38SX9C-TDS	53	CCR-38SX90-TDS	95	CCR-38SX0C-TDS
12	CCR-38SX9C-TM	54	CCR-38SX90-TM	96	CCR-38SX0C-TM
13	CCR-38SX9C-TMS	55	CCR-38SX90-TMS	97	CCR-38SX0C-TMS
14	CCR-38SX9C-TS	56	CCR-38SX90-TS	98	CCR-38SX0C-TS
15	CCR-38SX90	57	CCR-38SX0C	99	CCR-38SX00
16	CCR-38SX90-D	58	CCR-38SX0C-D	100	CCR-38SX00-D
17	CCR-38SX90-DM	59	CCR-38SX0C-DM	101	CCR-38SX00-DM
18	CCR-38SX90-M	60	CCR-38SX0C-M	102	CCR-38SX00-M
19	CCR-38SX90-MS	61	CCR-38SX0C-MS	103	CCR-38SX00-MS
20	CCR-38SX90-S	62	CCR-38SX0C-S	104	CCR-38SX00-S
21	CCR-38SX90-T	63	CCR-38SX0C-T	105	CCR-38SX00-T
22	CCR-38SX90-TD	64	CCR-38SX0C-TD	106	CCR-38SX00-TD
23	CCR-38SX90-TDM	65	CCR-38SX0C-TDM	107	CCR-38SX00-TDM
24	CCR-38SX90-TDMS	66	CCR-38SX0C-TDMS	108	CCR-38SX00-TDMS
25	CCR-38SX90-TDS	67	CCR-38SX0C-TDS	109	CCR-38SX00-TDS
26	CCR-38SX90-TM	68	CCR-38SX0C-TM	110	CCR-38SX00-TM
27	CCR-38SX90-TMS	69	CCR-38SX0C-TMS	111	CCR-38SX00-TMS
28	CCR-38SX90-TS	70	CCR-38SX0C-TS	112	CCR-38SX00-TS
29	CCR-38SX9C	71	CCR-38SX00		
30	CCR-38SX9C-D	72	CCR-38SX00-D		
31	CCR-38SX9C-DM	73	CCR-38SX00-DM		
32	CCR-38SX9C-M	74	CCR-38SX00-M		
33	CCR-38SX9C-MS	75	CCR-38SX00-MS		
34	CCR-38SX9C-S	76	CCR-38SX00-S		
35	CCR-38SX9C-T	77	CCR-38SX00-T		
36	CCR-38SX9C-TD	78	CCR-38SX00-TD		
37	CCR-38SX9C-TDM	79	CCR-38SX00-TDM		
38	CCR-38SX9C-TDMS	80	CCR-38SX00-TDMS		
39	CCR-38SX9C-TDS	81	CCR-38SX00-TDS		
40	CCR-38SX9C-TM	82	CCR-38SX00-TM		
41	CCR-38SX9C-TMS	83	CCR-38SX00-TMS		
42	CCR-38SX9C-TS	84	CCR-38SX00-TS		

* X = 1 (28Vdc), 2 (15Vdc), 3 (12Vdc) and 4 (24Vdc)