



PART NUMBER	DESCRIPTION
CCR-58S	Normally Open Multi-throw, DC-18 GHz
CR-58S	Elite, Normally Open Multi-throw, DC-18 GHz

The CCR-58S/CR-58S is a broadband, multi-throw, electromechanical coaxial switch designed to switch a microwave signal from a common input to any 10 outputs. The characteristic impedance is 50 Ohms. The switches are small using the popular connector spacing on a 1.740" dia. circle. Each position has an individual actuator mechanism allowing random position selection. This also gives the minimum switching time. With the normally open actuator, all paths are open when the switch is de-energized.



ENVIRONMENTAL AND PHYSICAL CHARACTERISTICS	
Storage Temperature	-55°C to 90°C
Operating Temperature	
Commercial Model, CCR-58S	-25°C to 65°C
Elite Model, CR-58S	-40°C to 85°C
Vibration <sup>1</sup> , 10 ~ 2000 Hz, 300 s MIL-STD-202 Method 204, Condition C	10 G peak
Shock, Half-Sine Pulse MIL-STD-202 Method 213, Condition D	500 G peak
Moisture Resistance <sup>2</sup>	95% RH Non-condensing
Mechanical Life	3,000,000 cycles (min)
Mechanical Life w/ Additional Features	1,000,000 cycles (min)
Connector Type	SMA
Weight	9 oz. (255.2G) (max.)

ELECTRICAL CHARACTERISTICS	
RF Contacts	Break before make
Frequency Range	DC–18 GHz
Characteristic Impedance	50Ω
Operate Time	20 ms (max.)
Release Time	20 ms (max.)
Actuation Voltage (Vdc) 20°C	12 15 24 28 V
Actuation Current, max. @ ambient	580 720 345 405 mA
TTL/Decoders Voltage/Current <sup>1</sup>	
Low Level (Logic 0)	0.0 ~ 0.7 V / 3.2 mA Max at 0.7 V
High Level (Logic 1)	2.4 ~ 5.5 V / 80 μA Max at 2.4 V
Indicator Contact Rating <sup>2</sup>	30 Vdc, 50 mA max
Magnetic Sensitivity	5 Gauss, 0.5 inch max

1. Non-operating
2. When moisture seal option is selected

1. For switches with TTL driver or decoder
2. For switches with indicator

RF PERFORMANCE CHARACTERISTICS					
Frequency	DC–2 GHz	2–4 GHz	4–8 GHz	8-12 GHz	12-18 GHz
Insertion Loss, dB, typ.	0.20	0.30	0.40	0.50	0.70
Isolation, dB, typ.	80	75	70	65	60
VSWR, typ.	1.20:1	1.30:1	1.40:1	1.50:1	1.70:1

Please see performance curves on pages 5.

### PART NUMBERING SYSTEM

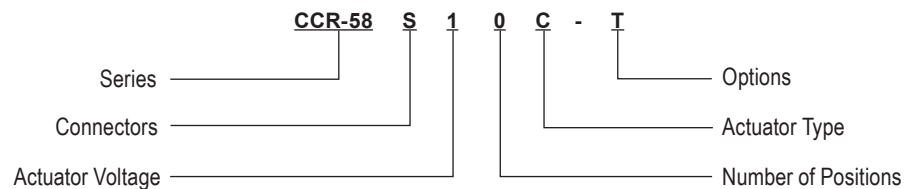

Connector	Actuator Voltage	Number of Positions	Actuator Type	Options
S: SMA Female	1: 28 Vdc Normally Open 2: 15 Vdc Normally Open 3: 12 Vdc Normally Open 4: 24 Vdc Normally Open	0: SP10T	0: No Indicator Contacts C: Indicator Contacts	T: TTL Drivers with Diodes D: Coil Transient Suppression Diodes S: D-Sub Connector* TD: Decoders and TTL Drivers with Diodes M: Moisture Seal

For additional options, please contact factory.

\* D-Sub Connector may be 15 or 25 pin depending on number of throws. (See Connector Pinout page)

# Series CCR-58S/CR-58S

Multi-Throw DC-18 GHz, SP10T

Normally Open Coaxial Switch



## SCHEMATICS AND MECHANICAL OUTLINE

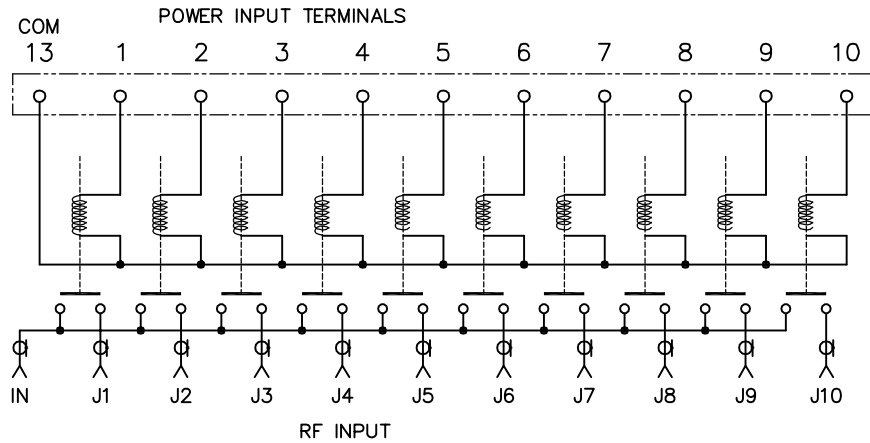

**SCHEMATIC  
SHOWN IN  
NORMALLY OPEN POSITION**

### “-TS OR -TDS OPTIONS” 15-PIN D-SUB OR 25-PIN D-MICRO CONNECTOR (EXAMPLE: CCR-58S100-TS or CCR-58S100-TDS)

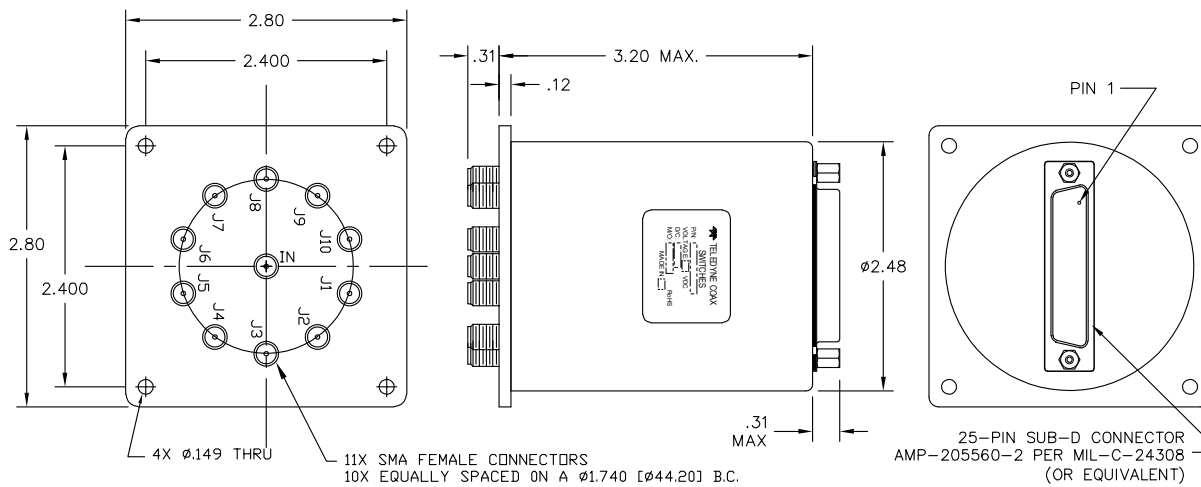

### “-S OPTION” 15-PIN D-SUB OR 25-PIN D-MICRO CONNECTOR (EXAMPLE: CCR-58S100-S)

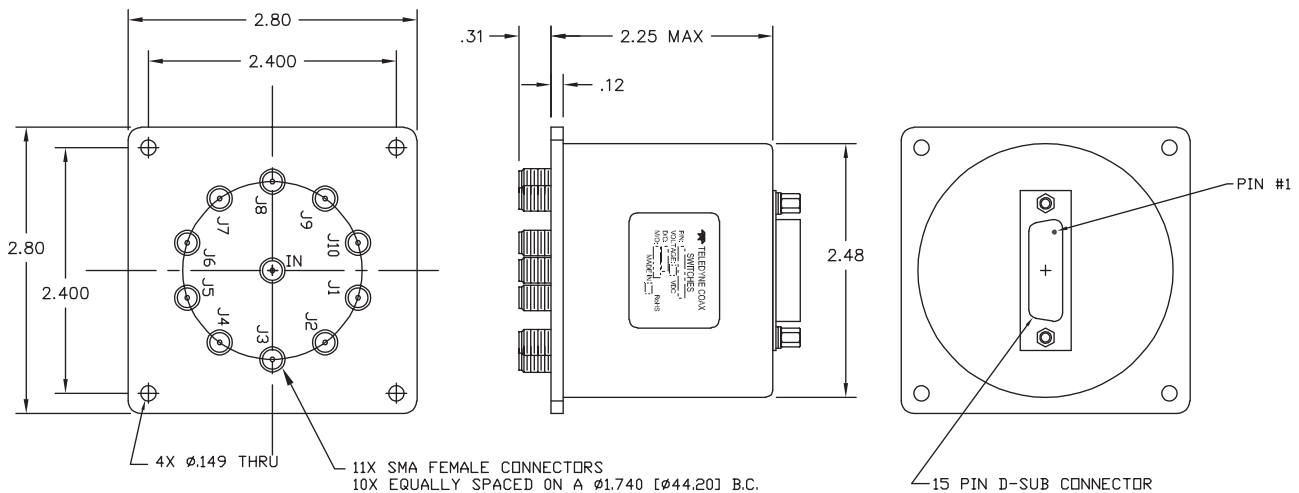

**CONNECTOR PINOUT FOR NORMALLY OPEN SP10T MULTI-THROW SWITCHES**

OPTIONS						
Pin No.	Basic (15-PIN)	Indicators (25-PIN)	TTL (15-PIN)	Indicators & TTL (25-PIN)	TTL + Decoder (15-PIN)	Indicators & TTL + Decoder (26 PIN)
1	PORT 1	PORT 1	TTL 1	TTL 1	LOGIC 1	LOGIC 1
2	PORT 2	PORT 2	TTL 2	TTL 2	LOGIC 2	LOGIC 2
3	PORT 3	PORT 3	TTL 3	TTL 3	LOGIC 3	LOGIC 3
4	PORT 4	PORT 4	TTL 4	TTL 4	LOGIC 4	LOGIC 4
5	PORT 5	PORT 5	TTL 5	TTL 5		
6	PORT 6	PORT 6	TTL 6	TTL 6		
7	PORT 7	PORT 7	TTL 7	TTL 7		
8	PORT 8	PORT 8	TTL 8	TTL 8		
9	PORT 9	PORT 9	TTL 9	TTL 9		
10	PORT 10	PORT 10	TTL 10	TTL 10		
11			Vsw	Vsw	Vsw	Vsw
12						
13	Common	Common	Common	Common	Common	Common
14						
15		D Indicator (com)		D Indicator (com)		D Indicator (com)
16		E Indicator		E Indicator		E Indicator
17		F Indicator		F Indicator		F Indicator
18		G Indicator		G Indicator		G Indicator
19		H Indicator		H Indicator		H Indicator
20		K Indicator		K Indicator		K Indicator
21		L Indicator		L Indicator		L Indicator
22		M Indicator		M Indicator		M Indicator
23		N Indicator		N Indicator		N Indicator
24		P Indicator		P Indicator		P Indicator
25		T Indicator		T Indicator		T Indicator
Example P/Ns						
P/N	CCR-58S100-S	CCR-58S10C-S	CCR-58S100-TS	CCR-58S10C-TS	CCR-58S100-TDS	CCR-58S10C-TDS

**Series CCR-58S/CR-58S**  
**Multi-Throw DC-18 GHz, SP10T**  
**Normally Open Coaxial Switch**



**SP10T TRUTH TABLE Normally Open**  
**CCR-58SX0C-T**

Logic Input										RF Path										Indicator Switches										
1	2	3	4	5	6	7	8	9	10	J1	J2	J3	J4	J5	J6	J7	J8	J9	J10	E	F	G	H	K	L	M	N	P	T	
1	0	0	0	0	0	0	0	0	0	On	Off	Off	Off	Off	Off	Off	Off	Off	Off	C	0	0	0	0	0	0	0	0	0	
0	1	0	0	0	0	0	0	0	0	Off	On	Off	Off	Off	Off	Off	Off	Off	Off	0	C	0	0	0	0	0	0	0	0	
0	0	1	0	0	0	0	0	0	0	Off	Off	On	Off	Off	Off	Off	Off	Off	Off	0	0	C	0	0	0	0	0	0	0	
0	0	0	1	0	0	0	0	0	0	Off	Off	Off	On	Off	Off	Off	Off	Off	Off	0	0	0	C	0	0	0	0	0	0	
0	0	0	0	1	0	0	0	0	0	Off	Off	Off	Off	On	Off	Off	Off	Off	Off	0	0	0	0	C	0	0	0	0	0	
0	0	0	0	0	1	0	0	0	0	Off	Off	Off	Off	Off	On	Off	Off	Off	Off	0	0	0	0	0	C	0	0	0	0	
0	0	0	0	0	0	1	0	0	0	Off	Off	Off	Off	Off	Off	On	Off	Off	Off	0	0	0	0	0	0	C	0	0	0	
0	0	0	0	0	0	0	1	0	0	Off	Off	Off	Off	Off	Off	Off	On	Off	Off	0	0	0	0	0	0	0	C	0	0	
0	0	0	0	0	0	0	0	1	0	Off	Off	Off	Off	Off	Off	Off	Off	On	Off	0	0	0	0	0	0	0	0	C	0	
0	0	0	0	0	0	0	0	0	1	Off	Off	Off	Off	Off	Off	Off	Off	Off	On	0	0	0	0	0	0	0	0	0	C	0
0	0	0	0	0	0	0	0	0	1	Off	Off	Off	Off	Off	Off	Off	Off	Off	Off	0	0	0	0	0	0	0	0	0	0	C
0	0	0	0	0	0	0	0	0	1	Off	Off	Off	Off	Off	Off	Off	Off	Off	Off	0	0	0	0	0	0	0	0	0	0	C

**TRUTH TABLE Normally Open**  
**CCR-58SX0C-TD**

Logic Input				RF Path										Indicator Switches									
1	2	3	4	J1	J2	J3	J4	J5	J6	J7	J8	J9	J10	E	F	G	H	K	L	M	N	P	T
0	0	0	0	On	Off	Off	Off	Off	Off	Off	Off	Off	Off	C	0	0	0	0	0	0	0	0	0
1	0	0	0	Off	On	Off	Off	Off	Off	Off	Off	Off	Off	0	C	0	0	0	0	0	0	0	0
0	1	0	0	Off	Off	On	Off	Off	Off	Off	Off	Off	Off	0	0	C	0	0	0	0	0	0	0
1	1	0	0	Off	Off	Off	On	Off	Off	Off	Off	Off	Off	0	0	0	C	0	0	0	0	0	0
0	0	1	0	Off	Off	Off	Off	On	Off	Off	Off	Off	Off	0	0	0	0	C	0	0	0	0	0
1	0	1	0	Off	Off	Off	Off	Off	On	Off	Off	Off	Off	0	0	0	0	0	C	0	0	0	0
0	1	1	0	Off	Off	Off	Off	Off	Off	On	Off	Off	Off	0	0	0	0	0	0	C	0	0	0
1	1	1	0	Off	Off	Off	Off	Off	Off	Off	On	Off	Off	0	0	0	0	0	0	0	C	0	0
0	0	0	1	Off	Off	Off	Off	Off	Off	Off	Off	On	Off	0	0	0	0	0	0	0	0	C	0
1	0	0	1	Off	Off	Off	Off	Off	Off	Off	Off	Off	On	0	0	0	0	0	0	0	0	0	C
1	1	1	1	Off	Off	Off	Off	Off	Off	Off	Off	Off	Off	0	0	0	0	0	0	0	0	0	0

**RF PERFORMANCE CURVES**

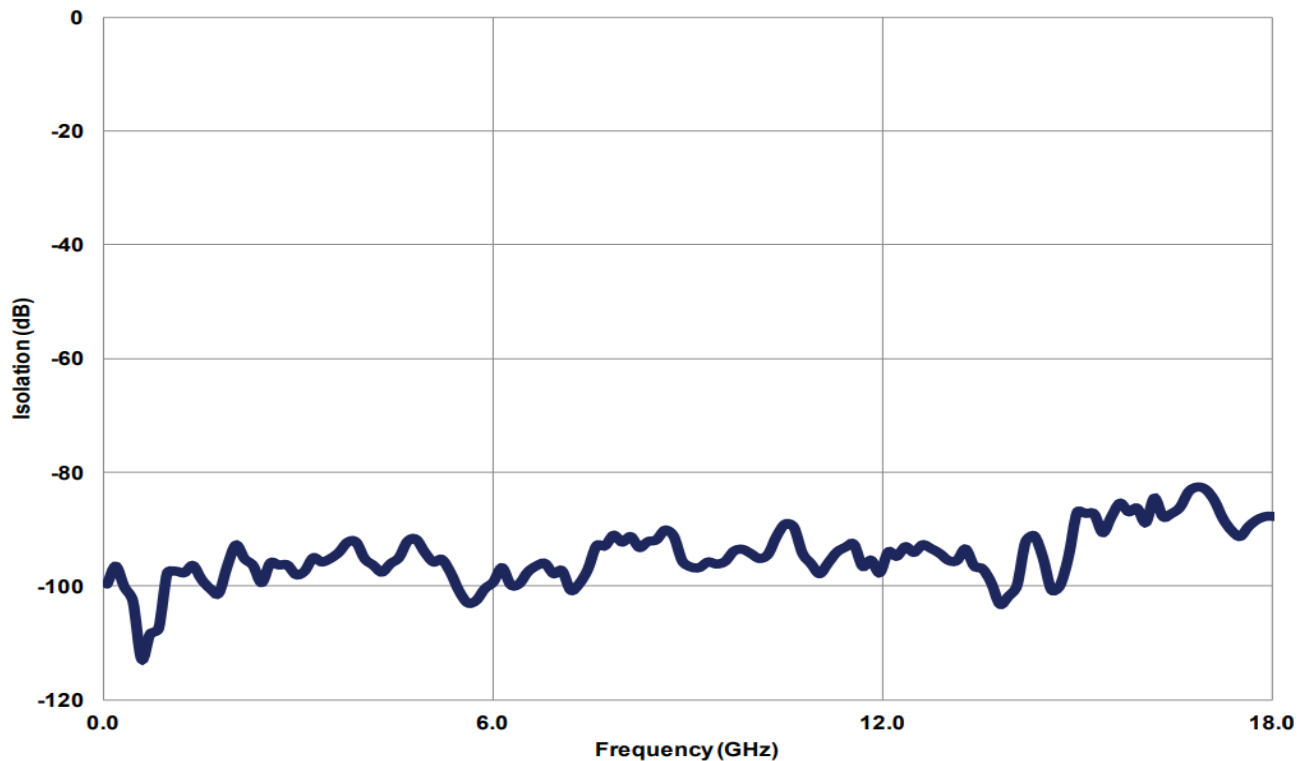
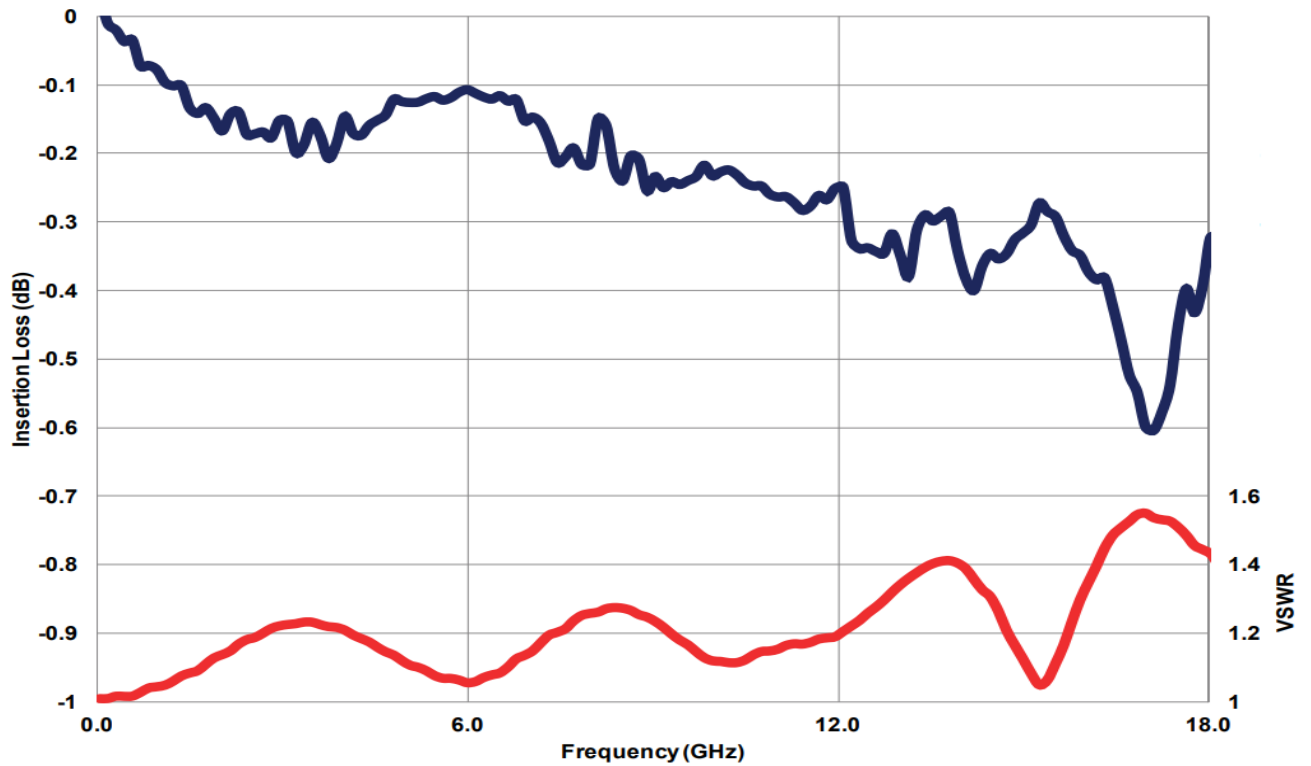



**TYPICAL POWER PERFORMANCE CURVE**

# Power Handling vs. Frequency

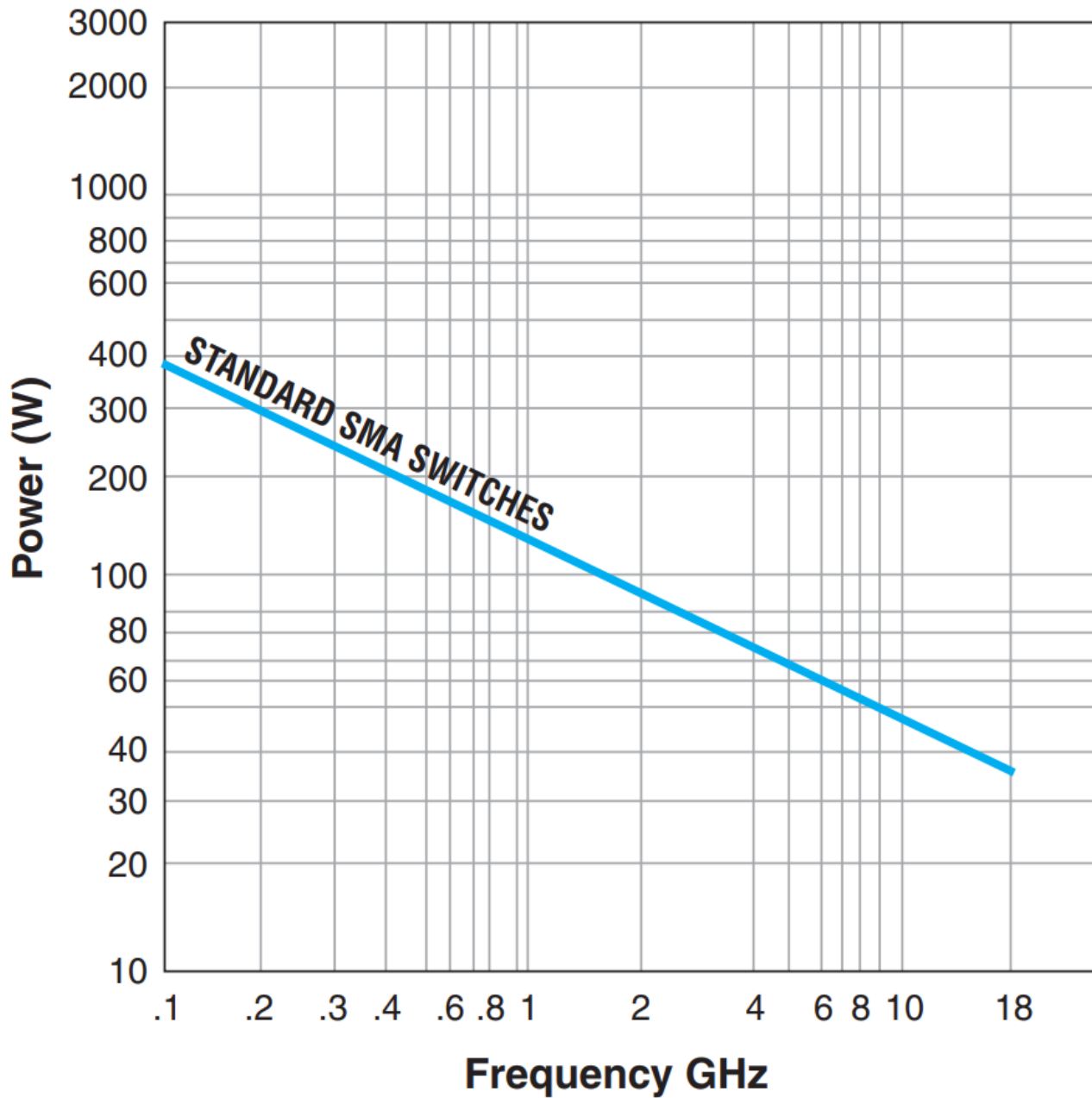

Estimates based on the following reference conditions:

- Ambient temperature of 40°C or less
- Sea level operation
- Load VSWR of 1.20:1 maximum
- No high-power (hot) switching

Please contact Teledyne Coax Switches for derating factors when applications do not meet the foregoing reference conditions.

## GLOSSARY

### Actuator

An actuator is the electromechanical mechanism that transfers the RF contacts from one position to another upon DC command.

### Arc Suppression Diode

A diode is connected in parallel with the coil. This diode limits the “reverse EMF spike” generated when the coil de-energizes to 0.7 volts. The diode cathode is connected to the positive side of the coil and the anode is connected to the negative side.

### Date Code

All switches are marked with either a unique serial number or a date code. Date codes are in accordance with MIL-STD-1285 Paragraph 5.2.5 and consist of four digits. The first two digits define the year and the last two digits define the week of the year (YYWW). Thus, 1032 identifies switches that passed through final inspection during the 32nd week of 2010.

### Indicator

Indicators tell the system which position the switch is in. Other names for indicators are telemetry contacts or tellback circuit. Indicators are usually a set of internally mounted DC contacts linked to the actuator. They can be wired to digital input lines, status lights, or interlocks. Unless otherwise specified, the maximum indicator contact rating is 30 Vdc, 50 mA, or 1.5 Watts into a resistive load.

### Isolation

Isolation is the measure of the power level at the output connector of an unconnected RF channel as referenced to the power at the input connector. It is specified in dB below the input power level.

### Multi-Throw Switch

A multi-throw switch is a switch with one input and three or more output ports. The CCR-58 can switch a microwave signal to any of 10 outputs from a single common input.

### Switching Time

Switching time is the total interval beginning with the arrival of the leading edge of the command pulse at the switch DC input and ending with the completion of the switch transfer, including contact bounce. It consists of three parts: (1) inductive delay in the coil, (2) transfer time of the physical movement of the contacts, and (3) the bounce time of the RF contacts.

### TTL Switch Driver Option

As a special option, switch drivers can be provided for both failsafe and latching switches, which are compatible with industry-standard low-power Schottky TTL circuits.

### TD-Option

This option includes a decoder. The 3-bit parallel command is decoded to internally select the appropriate position. See the logic tables. The TD-Option increases the Vsw supply current demand by 50mA max at 28Vdc and +20°C.

### Performance Parameters vs Frequency

Generally speaking, the RF performance of coaxial switches is frequency dependent. With increasing frequency, VSWR and insertion loss increase while isolation decreases. All data sheets specify these three parameters as “worst case” at the highest operating frequency. If the switch is to be used over a narrow frequency band, better performance can be achieved.

### Actuator Current vs Temperature

The resistance of the actuator coil varies as a function of temperature. There is an inverse relationship between the operating temperature of the switch and the actuator drive current. For switches operating at 28 VDC, the approximate actuator drive current at temperature, T, can be calculated using the equation:

$$I_T = \frac{I_A}{[1 + .00385 (T-20)]}$$

Where:

$I_T$  = Actuator current at temperature, T

$I_A$  = Room temperature actuator current – see data sheet

T = Temperature of interest in °C

### Magnetic Sensitivity

An electro-mechanical switch can be sensitive to ferrous materials and external magnetic fields. Neighboring ferrous materials should be permitted no closer than 0.5 inches and adjacent external magnetic fields should be limited to a flux density of less than 5 Gauss.