



**DETAIL SPECIFICATION FOR  
HIREL 422 RELAYS**

**RELAYS, HIGH RELIABILITY,  
ELECTROMECHANICAL, LATCHING, DPDT,  
LOW LEVEL TO 1.0 AMPERE,  
WITH OPTIONAL DIODE(S) FOR  
COIL TRANSIENT SUPPRESSION AND  
POLARITY REVERSAL PROTECTION**

**TR-HIREL-1/422**

**ISSUE 3**

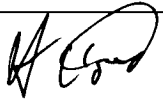
**27 May 2015**

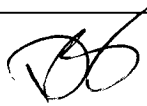
Issue or Amendment No.	Date of Issue	Approved by			
		Engineering	Operations	Product Assurance	Marketing
Issue 1	27 Feb 2001	AC / DC	H. Wood	SRL	DY
Issue 2	18 June 2013	MT	H. Wood	N. Kiyani	DY
Issue 3	27 May 2015	MT		NK 	

**TABLE OF CONTENTS.**

<b>1. SCOPE .....</b>	<b>5</b>
<b>2. RELAY CHARACTERISTICS .....</b>	<b>6</b>
2.1. <b>GENERAL DATA. ....</b>	<b>6</b>
2.1.1. <i>Contact arrangement. ....</i>	<i>6</i>
2.1.2. <i>Temperature range. ....</i>	<i>6</i>
2.1.3. <i>Dimensions and configuration. ....</i>	<i>6</i>
2.1.4. <i>Weight. ....</i>	<i>6</i>
2.1.5. <i>Seal. ....</i>	<i>6</i>
2.1.6. <i>Finish of the terminals. ....</i>	<i>6</i>
2.2. <b>PART NUMBER (ORDERING INFORMATION). ....</b>	<b>6</b>
2.3. <b>CONTACT DATA. ....</b>	<b>7</b>
2.3.1. <i>Contact load and life ratings. ....</i>	<i>7</i>
2.3.2. <i>Static contact resistance or voltage drop. ....</i>	<i>7</i>
2.3.3. <i>Contact bounce time (when specified, see TR-HIREL-1/Supplement 1). ....</i>	<i>7</i>
2.3.4. <i>Contact stabilization time (when specified, see TR-HIREL-1/Supplement 1). ....</i>	<i>7</i>
2.4. <b>ELECTRICAL DATA. ....</b>	<b>9</b>
2.4.1. <i>Insulation resistance. ....</i>	<i>9</i>
2.4.2. <i>Dielectric withstanding voltage. ....</i>	<i>9</i>
2.4.3. <i>Coil data and operating characteristics. ....</i>	<i>10</i>
2.4.4. <i>Timing (over the temperature range). ....</i>	<i>10</i>
2.4.5. <i>Diode characteristics. ....</i>	<i>10</i>
2.5. <b>MOUNTING VARIANTS. ....</b>	<b>13</b>
2.6. <b>TERMINATION VARIANTS. ....</b>	<b>14</b>
2.7. <b>TESTING SELECTION ID DESIGNATOR. ....</b>	<b>15</b>
2.7.1. <i>Manufacturing Variants. ....</i>	<i>15</i>
2.7.2. <i>Screening Variants. ....</i>	<i>15</i>
2.8. <b>ENVIRONMENTAL DATA. ....</b>	<b>17</b>
<b>3. MARKING.....</b>	<b>18</b>
<b>4. QUALITY ASSURANCE.....</b>	<b>18</b>
4.1. <b>FINAL PRODUCTION TESTS. ....</b>	<b>18</b>
4.2. <b>SCREENING AND ELECTRICAL MEASUREMENTS. ....</b>	<b>18</b>
4.3. <b>LOT ACCEPTANCE TESTS (WHEN SPECIFIED, SEE TR-HIREL-1/SUPPLEMENT 1). ....</b>	<b>18</b>
<b>5. GENERAL NOTES.....</b>	<b>29</b>

**TABLE OF TABLES.**

TABLE 1. CONTACT LOAD AND LIFE RATINGS. ....	7
TABLE 2. STATIC CONTACT RESISTANCE OR VOLTAGE DROP. ....	8
TABLE 3. POINTS OF APPLICATION AND MEASUREMENT FOR INSULATION RESISTANCE AND DIELECTRIC WITHSTANDING VOLTAGE TESTS. ....	9
TABLE 4. COIL DATA AND OPERATING CHARACTERISTICS OF BASIC RELAYS AND OF RELAYS WITH OPTIONAL DIODE FOR COIL TRANSIENT SUPPRESSION. ....	11
TABLE 5. COIL DATA AND OPERATING CHARACTERISTICS OF RELAYS WITH INTERNAL DIODES FOR COIL TRANSIENT SUPPRESSION AND POLARITY REVERSAL PROTECTION. ....	12
TABLE 6. MOUNTING VARIANTS. ....	13
TABLE 7. TERMINATION VARIANTS. ....	14
TABLE 8. MANUFACTURING VARIANTS. ....	15
TABLE 9. SCREENING VARIANTS. ....	16
TABLE 10. ENVIRONMENTAL TESTS. ....	17
TABLE 11. FINAL PRODUCTION TESTS. <u>1/</u> ....	19
TABLE 12. SCREENING AND ELECTRICAL MEASUREMENTS. <u>1/</u> ....	20
TABLE 13. LOT ACCEPTANCE TEST 3. <u>1/</u> ....	22
TABLE 14. LOT ACCEPTANCE TEST 2. <u>1/</u> ....	23
TABLE 15. LOT ACCEPTANCE TEST 1. <u>1/</u> ....	27

**TABLE OF FIGURES.**

FIGURE 1. OUTLINE DIMENSIONS. ....	5
FIGURE 2. TERMINAL LOCATIONS AND CIRCUIT DIAGRAM (BOTTOM VIEW). ....	5
FIGURE 3. GROUND PIN POSITIONS. ....	13

**TABLE OF APPENDICES.**

APPENDIX A. MOUNTING AND TERMINATION VARIANTS. ....	30
APPENDIX B. DOCUMENT CHANGE HISTORY. ....	34

DETAIL SPECIFICATION FOR 422K RELAYS

**Relays, High Reliability, Electromechanical, Latching, DPDT, Low Level to 1.0 Ampere, With Optional Diode(s) For Coil Transient Suppression**

**1. SCOPE**

The performance and testing specifications for the above-referenced product are set forth in this detail specification. References to TR-HIREL-1 are to the most recent version thereof; in the event of conflict between this detail specification and TR-HIREL-1, the specifications set forth in this detail specification shall prevail.

**Figure 1. Outline dimensions.**

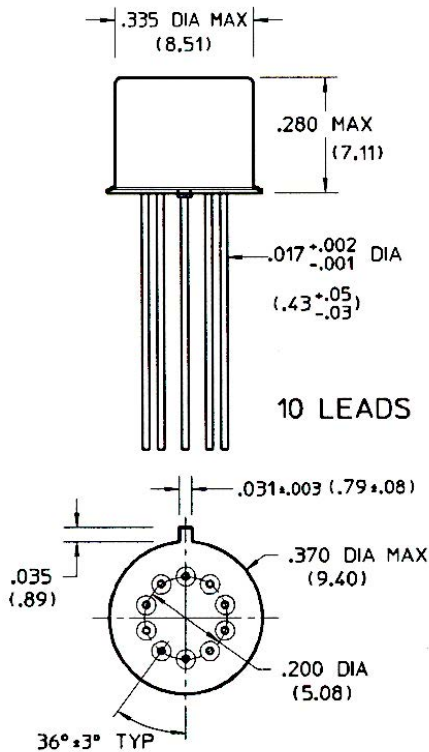

**Figure 2. Terminal locations and circuit diagram (bottom view).**

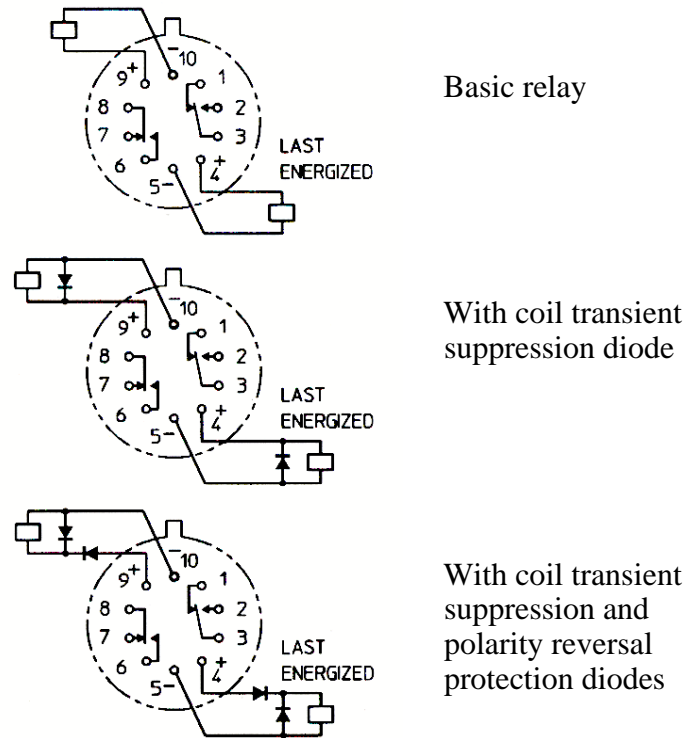

**Notes to Figures 1 and 2:**

1. The standard configuration is shown in Figure 1. See Appendix A herein for mounting and termination variants.
2. Dimensions are in inches. Metric equivalents in mm are given in parentheses.
3. Unless otherwise specified, the tolerance on dimensions is  $\pm 0.010$  in. ( $\pm 0.254$  mm).
4. Circuit diagrams shown in Figure 2 are terminal views (as seen from the bottom of the relays).
5. Terminal numbers are not marked on the relays.

**2. RELAY CHARACTERISTICS**

**2.1. General Data.**

**2.1.1. Contact arrangement.**

DPDT (2 Form C).

**2.1.2. Temperature range.**

-65 °C to +125 °C.

**2.1.3. Dimensions and configuration.**

See Figure 1 and Appendix A herein.

**2.1.4. Weight.**

2.84 g (0.10 oz) maximum.

- For relays supplied with M or M3 spreader pad (see Appendix A herein and TR-HIREL-1/Supplement 1), 3.09 g (0.109 oz) maximum.

**2.1.5. Seal.**

Hermetic. Leak rate  $1 \times 10^{-6}$  atm-cm<sup>3</sup>/s of air maximum.

**2.1.6. Finish of the terminals.**

Gold plated or solder coated (see Appendix A herein and TR-HIREL-1/Supplement 1).

**2.2. Part Number (ordering information).**

See TR-HIREL-1/Supplement 1 for checklist to be used for procurement.

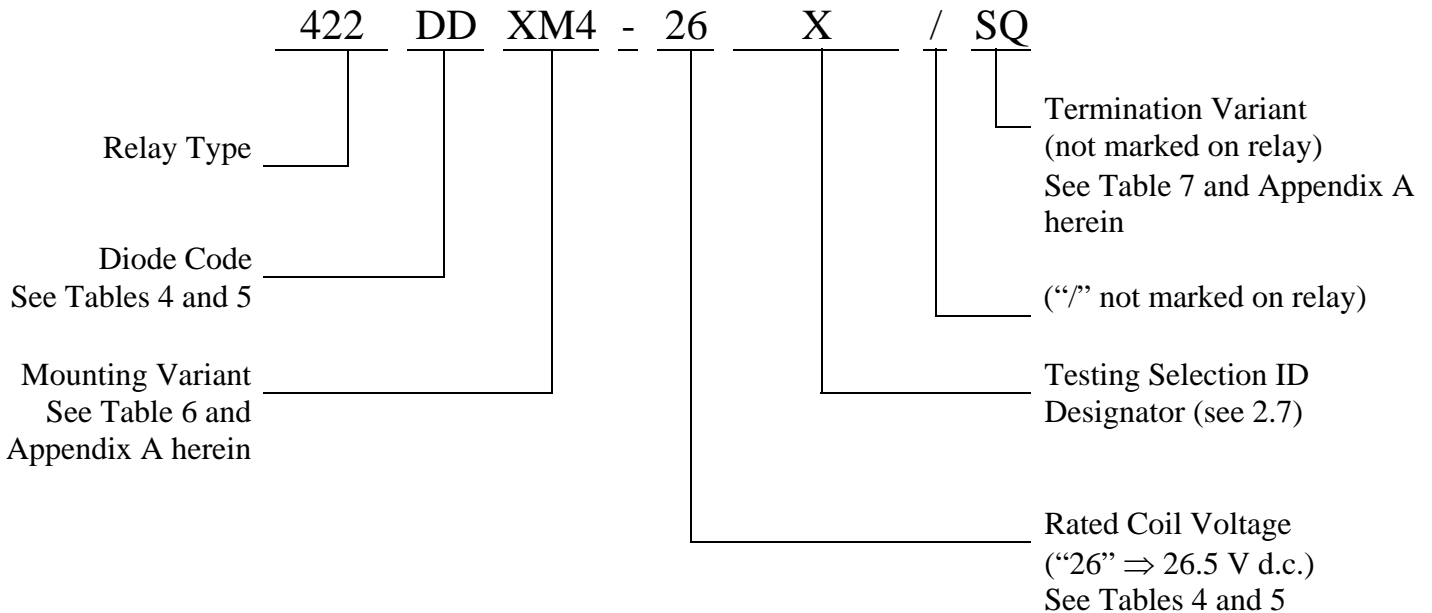

**2.3. Contact Data.**
**2.3.1. Contact load and life ratings.**

See Table 1.

**2.3.2. Static contact resistance or voltage drop.**

 See Table 2. Contact resistance measurements shall be made at approximately  $\frac{1}{8}$  in. from the emergence of the lead from the seating plane of the relay.

**2.3.3. Contact bounce time (when specified, see TR-HIREL-1/Supplement 1).**

2.0 ms maximum.

**2.3.4. Contact stabilization time (when specified, see TR-HIREL-1/Supplement 1).**

2.5 ms maximum.

**Table 1. Contact Load and Life Ratings.**

Load level	Contact load <sup>1/</sup>	Contact life
Low level/Mechanical	10 – 50 $\mu$ A at 10 – 50 mV d.c. or peak a.c.	100,000 cycles rated life
		1,000,000 cycles unmonitored (Mechanical life)
Intermediate current	100 mA at 28 V d.c.	50,000 cycles
High level, resistive	1.0 A at 28 V d.c.	100,000 cycles
High level, inductive	200 mA at 28 V d.c., with 0.32 H inductance	100,000 cycles
High level, lamp	100 mA at 28 V d.c.	100,000 cycles
Overload, resistive	2.0 A at 28 V d.c.	100 cycles

**Notes to Table 1:**  
<sup>1/</sup> Relay case is grounded, unless otherwise specified.

**Table 2. Static Contact Resistance or Voltage Drop.**

Measurement condition		Maximum static contact resistance or voltage drop		
		without attached spacer/spreader pad	with M4 spacer pad attached	with M or M3 spreader pad attached
Initial		0.125 $\Omega$	0.135 $\Omega$	0.150 $\Omega$
Low level life	during life	33 $\Omega$ (1.65 mV d.c. monitoring level)		
	after 100,000 or 1,000,000 cycle life	0.175 $\Omega$	0.185 $\Omega$	0.200 $\Omega$
Intermediate current	during test	1 $\Omega$ (100 mV d.c. monitoring level)		
	after 50,000 cycle test	0.225 $\Omega$	0.235 $\Omega$	0.250 $\Omega$
High level life	during life	voltage drop no more than 5 % of open circuit voltage (1.4 V d.c. monitoring level)		
	after 100,000 cycle life	0.225 $\Omega$	0.235 $\Omega$	0.250 $\Omega$
Overload	during life	not monitored		
	after 100 cycle life	0.225 $\Omega$	0.235 $\Omega$	0.250 $\Omega$



**2.4. Electrical Data.**
**2.4.1. Insulation resistance.**

Points of measurement are as specified in Table 3. Coil leads of relays supplied with internal diode(s) should be connected together to avoid damage to the diode(s).

10,000 M $\Omega$  minimum at 500 V d.c., except as follows:

1,000 M $\Omega$  minimum at 500 V d.c. between coil and case at +125 °C

1,000 M $\Omega$  minimum at 500 V d.c. after 100 cycle overload,

100,000 cycle high level life, or 50,000 cycle intermediate current tests

**2.4.2. Dielectric withstanding voltage.**

Points of application are as specified in Table 3. Coil leads of relays supplied with internal diode(s) should be connected together to avoid damage to the diode(s).

**2.4.2.1. At atmospheric pressure.**

500 V r.m.s.  $\pm$  5 % at 50 or 60 Hz (as applicable), except as follows:

375 V r.m.s. at 50 or 60 Hz (as applicable) after 100 cycle overload, 100,000 cycle high level life, or 50,000 cycle intermediate current tests

**Table 3. Points of Application and Measurement for Insulation Resistance and Dielectric Withstanding Voltage Tests.**

<b>Points of Application / Measurement</b>	<b>Reset position</b>	<b>Set position</b>
Between case, frame, or enclosure, and all contacts	✓	✓
Between case, frame, or enclosure and coils	✓	
Between all contacts and coils	✓	
Between open contacts	✓	✓
Between contact poles	✓	✓
Between coils	✓	

2.4.3. **Coil data and operating characteristics.**

See Table 4.

2.4.4. **Timing (over the temperature range).**

2.4.4.1. **Operate time.**

2.0 ms maximum with rated coil voltage.

2.4.5. **Diode characteristics.**

2.4.5.1. **Coil transient suppression.**

1.0 V d.c. maximum negative transient.

2.4.5.2. **Block integrity maximum leakage current.**

1  $\mu$ A at 50 V d.c.

2.4.5.3. **Breakdown voltage.**

100 V d.c. minimum at 10  $\mu$ A.

**Table 4. Coil Data and Operating Characteristics of Basic Relays and of Relays with Optional Diode for Coil Transient Suppression.**

Coil voltage (V d.c.) <u>2/</u> <u>3/</u>		Room ambient temperature (+25 °C)		Over temperature range	Coil transient suppression diode code <u>5/</u>
Rated	Max	Coil resistance (Ω) ± 10 %	Set/reset voltage (V d.c.) max <u>4/</u>	Set/reset voltage (V d.c.) max <u>4/</u>	
5.0	6.0	61	2.8	3.5	D
6.0	8.0	120	3.5	4.5	D
9.0	12.0	280	5.3	6.8	D
12.0	16.0	500	7.0	9.0	D
18.0	24.0	1130	10.5	13.5	D
26.5	32.0	2000	14.2	18.0	D

**Notes to Table 4:**

1. Each relay possesses high level and low level capabilities. However, relays previously tested or used above 10 mA resistive at 6 V d.c. maximum or peak a.c. open circuit are not recommended for subsequent use in low level applications.
- 2/ When latching relays are installed in equipment, the coils should not be pulsed simultaneously. Coils should not be pulsed with less than the rated coil voltage and the pulse width should be a minimum of three times the specified operate time of the relay. If these conditions are not followed, it is possible for the relay to be in the magnetically neutral position.
- 3/ The use of any coil voltage other than the rated coil voltage will affect the electrical and dynamic characteristics of the relay.
- 4/ Relay contacts shall transfer to the set/reset position at a voltage no greater than the maximum set/reset voltage.
- 5/ No code letter for relays without diode(s).

**Table 5. Coil Data and Operating Characteristics of Relays with Internal Diodes for Coil Transient Suppression and Polarity Reversal Protection.**

Coil voltage (V d.c.) <u>2/</u> <u>3/</u>		Room ambient temperature (+25 °C)			Set/reset voltage (V d.c.) max <u>5/</u>	Over tem- perature range	Coil transient suppression and polarity reversal protection diode code
		Coil resistance (ref. only) (Ω) <u>4/</u>	Coil circuit current (mA) <u>4/</u>				
Rated	Max		Max	Min			
5.0	6.0	48	104.2	75.8	3.5	4.5	DD
6.0	8.0	97	63.0	46.9	4.1	5.5	DD
9.0	12.0	280	33.7	26.0	6.3	7.8	DD
12.0	16.0	500	25.5	20.0	8.0	10.0	DD
18.0	24.0	1130	17.2	13.7	11.6	14.5	DD
26.5	32.0	2000	14.4	11.6	15.4	19.0	DD

**Notes to Table 5:**

1. Each relay possesses high level and low level capabilities. However, relays previously tested or used above 10 mA resistive at 6 V d.c. maximum or peak a.c. open circuit are not recommended for subsequent use in low level applications.
- 2/ When latching relays are installed in equipment, the coils should not be pulsed simultaneously. Coils should not be pulsed with less than the rated coil voltage and the pulse width should be a minimum of three times the specified operate time of the relay. If these conditions are not followed, it is possible for the relay to be in the magnetically neutral position.
- 3/ The use of any coil voltage other than the rated coil voltage will affect the electrical and dynamic characteristics of the relay.
- 4/ Coil resistance is not directly measurable at relay terminals; coil current shall be measured in lieu of coil resistance.
- 5/ Relay contacts shall transfer to the set/reset position at a voltage no greater than the maximum set/reset voltage.

**2.5. Mounting Variants.**

See Table 6 and Appendix A herein.

**Table 6. Mounting Variants.**

Mounting code	Type of mounting
No Code	Without mounting
X	Ground pin at position X
M	M spreader pad
M3	M3 spreader pad
M4	M4 spacer pad
XM3	Ground pin at positions X with M3 spreader pad
XM4	Ground pin at position X with M4 spacer pad

**Notes to Table 5:**

- Optional ground pins are non-insulated case grounds. See Figure 3 for available ground pin positions.
- M4 spacer pad is a polyester film and is attached to the relay.
- M and M3 spreader pads are made from diallyl phthalate and are attached to the relay.

**Figure 3. Ground Pin Positions.**

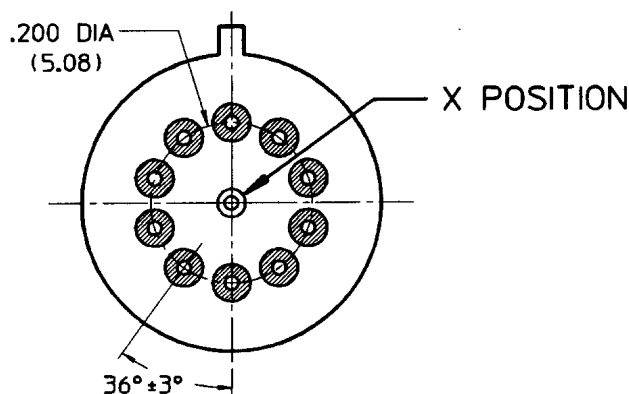

**2.6. Termination Variants.**

See Table 7 and Appendix A herein.

**Table 7. Termination Variants.**

Terminal code	Length of terminals			Finish <sup>1/</sup>
	Without attached spreader pad	With M or M3 spreader pad attached	With M4 spacer pad attached	
No Code	0.750 in. min. (19.05 mm)	0.370 in. min. (9.40 mm)	0.750 in. min. (19.05 mm)	Gold plated or solder coated
G	0.750 in. min. (19.05 mm)	0.370 in. min. (9.40 mm)	0.750 in. min. (19.05 mm)	Gold plated
Q	0.750 in. min. (19.05 mm)	0.370 in. min. (9.40 mm)	0.750 in. min. (19.05 mm)	Solder coated
S	0.187 ± 0.010 in. (4.75 ± 0.25 mm)	—	0.187 ± 0.010 in. (4.75 ± 0.25 mm)	Gold plated or solder coated
SG	0.187 ± 0.010 in. (4.75 ± 0.25 mm)	—	0.187 ± 0.010 in. (4.75 ± 0.25 mm)	Gold plated
SQ	0.187 ± 0.010 in. (4.75 ± 0.25 mm)	—	0.187 ± 0.010 in. (4.75 ± 0.25 mm)	Solder coated
W	1.50 in. min. (38.10 mm)	—	1.50 in. min. (38.10 mm)	Gold plated or solder coated
WG	1.50 in. min. (38.10 mm)	—	1.50 in. min. (38.10 mm)	Gold plated
WQ	1.50 in. min. (38.10 mm)	—	1.50 in. min. (38.10 mm)	Solder coated

**Notes to Table 7:**

<sup>1/</sup> Maximum lead diameter after solder coating is 0.020 in. (0.508 mm), except at the free end of the lead. Maximum lead diameter at the free end of the lead after solder coating is 0.025 in. (0.635 mm).

**2.7. Testing Selection ID Designator.**

The Testing Section ID Designator is an alphanumeric field that represents the combination of manufacturing and/or screening variants indicated below that are specified by the Orderer. Each combination of manufacturing and/or screening variants has a unique ID designator which is part of the Part Number (see 2.2). It allows the Orderer to select from specified manufacturing and/or screening variants based on program requirements.

**2.7.1. Manufacturing Variants.**

Prior to encapsulation, when specified (see TR-HIREL-1/Supplement 1), the relays shall be subjected to the tests/inspections specified in Table 8.

**2.7.2. Screening Variants.**

When specified (see TR-HIREL-1/Supplement 1), the relays shall be tested for the following attributes or shall be subjected to the tests/inspections of Table 9 as part of Quality Conformance Inspection. Refer to see TR-HIREL-1/Supplement 1 for a further breakdown of Lot Acceptance Test Level 2 and 1.

**Table 8. Manufacturing Variants.**

<b>Test</b>	<b>Requirement paragraph in TR-HIREL-1</b>	<b>Test method paragraph in TR-HIREL-1</b>
Small Particle Inspection	3.1	4.11.2

**Table 9. Screening Variants.**

<b>Test</b>	<b>Requirement paragraph in TR-HIREL-1</b>	<b>Test method paragraph in TR-HIREL-1</b>
Solderability	3.6.2	4.11.4
Vibration (random)	3.6.6	4.11.11.2
Vibration miss test	3.6.7	4.11.12
Particle impact noise detection	3.6.22	4.11.24
Contact bounce time	3.4.2.1	4.11.8.5.2
Contact stabilization time	3.4.2.2	4.11.8.5.3
Lot Acceptance Tests (Level 3)	3.1	4.10.3
Lot Acceptance Tests (Level 2)	3.1	4.10.3
Lot Acceptance Tests (Level 1)	3.1	4.10.3



**2.8. Environmental Data.**

The relays shall withstand the environmental tests as specified in Table 10.

**Table 10. Environmental Tests.**

<b>Test</b>	<b>Requirement paragraph in TR-HIREL-1</b>	<b>Test method paragraph in TR-HIREL-1</b>	<b>Details and exceptions</b>
Solderability	3.6.2	4.11.4	
Thermal shock	3.6.4	4.11.9	
Shock (specified pulse)	3.6.5	4.11.10	Test condition C (100 G peak half-sine , 6 ms duration)
Vibration (sinusoidal)	3.6.6	4.11.11.1	
Vibration (random)	3.6.6	4.11.11.2	
Terminal strength	3.6.8	4.11.21	
Coil life	3.6.9	4.11.22	
Resistance to soldering heat	3.6.10	4.11.18	
Salt atmosphere (corrosion)	3.6.11	4.11.13	Performance requirement.
Resistance to solvents	3.6.16	4.11.17	

**3. MARKING**

Marking on the relay includes Teledyne Relays' Part Number (see 2.2), Lot Number, circuit diagram, Teledyne Relays' name, serial number and contact current rating. The circuit diagram as marked on the relay is the terminal view.

**4. QUALITY ASSURANCE**

Quality assurance provisions are as specified in TR-HIREL-1. The following details shall apply:

**4.1. Final Production Tests.**

See Table 11.

**4.2. Screening and Electrical Measurements.**

See Table 12.

**4.3. Lot Acceptance Tests (when specified, see TR-HIREL-1/Supplement 1).**

See Tables 13, 14, 15.

**Table 11. Final Production Tests. 1/**

Inspection	Requirement in TR-HIREL-1	Test method in TR-HIREL-1	Details and exceptions in this spec	Diode Codes		
				None	D	DD
1. Verification of precap inspection, customer source inspection - precap inspection, Marking/serialization	Ref.: 3.6.18, 3.6.19	Ref. 4.11.1	2.2, 3.0	✓	✓	✓
2. Verification of small particle inspection (when specified)	3.1	4.11.2	2.7.1	✓	✓	✓
3. Room temperature electrical measurements <u>2/</u>						
a) Coil resistance	3.5.4	4.11.8.2	2.4.3	✓	✓	
b) Coil current	3.5.5	4.11.8.3	2.4.3			✓
c) Insulation resistance	3.5.1	4.11.6	2.4.1	✓	✓	✓
d) Dielectric withstanding voltage (atmospheric pressure)	3.5.2	4.11.7	2.4.2	✓	✓	✓
e) Static contact resistance	3.4.1.1	4.11.8.5.1	2.3.2	✓	✓	✓
f) Set/reset voltage	3.5.3.2	4.11.8.1.2	2.4.3	✓	✓	✓
g) Operate time	3.5.6	4.11.8.4	2.4.4	✓	✓	✓
h) Operate contact bounce time (when specified)	3.4.2.1	4.11.8.5.2	2.3.3, 2.7.2	✓	✓	✓
i) Operate contact stabilization time (when specified)	3.4.2.2	4.11.8.5.3	2.3.4, 2.7.2	✓	✓	✓
j) Coil transient suppression	3.5.7.1	4.11.8.6.1	2.4.5.1		✓	✓
k) Block integrity	3.5.7.2	4.11.8.6.2	2.4.5.2			✓
l) Neutral Screen	3.5.8	4.11.8.7		✓	✓	✓
4. Solderability <u>3/</u>	3.6.2	4.11.4	2.7.2, 2.8	✓	✓	✓
5. Seal	3.6.3	4.11.5	2.1.5	✓	✓	✓
6. Visual inspection, external <u>4/</u>	3.6.19	4.11.1.2	2.1.3, 2.1.4, 2.1.6, 2.2	✓	✓	✓

**Notes to Table 11:**

1/ 100% inspection applies, unless otherwise noted. For 100 % inspection, discard all failed relays.

2/ Test sequence is optional.

3/ Perform on 2 relays from each lot. Failed relays resulting from Room Temperature Electrical Measurements may be used for test.

4/ Physical dimensions and weight shall be measured on two sample units per lot.

**Table 12. Screening and Electrical Measurements. 1/**

Inspection	Requirement in TR-HIREL-1	Test method in TR-HIREL-1	Details and exceptions in this spec	Diode Codes		
				None	D	DD
1. Vibration, sinusoidal	3.6.6	4.11.11	2.8	✓	✓	✓
2. Vibration, random (when specified)	3.6.6	4.11.11.2	2.7.2, 2.8	✓	✓	✓
3. Vibration miss test (when specified)	3.6.7	4.11.12	2.7.2	✓	✓	✓
4. Particle impact noise detection (PIND) test (when specified)	3.6.22	4.11.24	2.7.2	✓	✓	✓
5. Internal moisture	3.6.1	4.11.3.1		✓	✓	✓
6. Thermal cycle/Miss test	3.6.20	4.11.3.3				
First four hot/cold cycles:						
High Temperature Soak		4.11.3.2		✓	✓	✓
a) Coil continuity		4.11.3.3.1		✓	✓	✓
Fifth hot/cold cycle:						
b) High temperature electrical measurements 2/		4.11.3.3.1				
i. Insulation resistance	3.5.1	4.11.6	2.4.1	✓	✓	✓
ii. Set/reset voltage	3.5.3.2	4.11.8.1.2	2.4.3	✓	✓	✓
iii. Static contact resistance	3.4.1.1	4.11.8.5.1	2.3.2	✓	✓	✓
iv. Operate time	3.5.6	4.11.8.4	2.4.4	✓	✓	✓
v. Operate contact bounce time	3.4.2.1	4.11.8.5.2	2.3.3	✓	✓	✓
c) High temperature Miss test	3.6.1	4.11.3.3.1, 4.11.3.3.2		✓	✓	✓
d) Low temperature soak		4.11.3.3.1		✓	✓	✓
f) Low temperature electrical measurements 2/		4.11.3.3.1				
i. Set/reset voltage	3.5.3.2	4.11.8.1.2	2.4.3	✓	✓	✓
ii. Static contact resistance	3.4.1.1	4.11.8.5.1	2.3.2	✓	✓	✓
iii. Operate time	3.5.6	4.11.8.4	2.4.4	✓	✓	✓
iv. Operate contact bounce time	3.4.2.1	4.11.8.5.2	2.3.3	✓	✓	✓

See notes at end of Table.

**Table 12. Screening and Electrical Measurements (cont'd). 1/**

Inspection	Requirement in TR-HIREL-1	Test method in TR-HIREL-1	Details and exceptions in this spec	Diode Codes		
				None	D	DD
7. Thermal cycle/Miss test (cont'd)						
g) Low temperature Miss test	3.6.1	4.11.3.2.1, 4.11.3.2.2		✓	✓	✓
h) Stabilize at room ambient temperature		4.11.3.2.1		✓	✓	✓
i) Room temperature Miss test	3.6.1	4.11.3.2.1, 4.11.3.2.2		✓	✓	✓
8. Room temperature electrical measurements <u>2/</u>						
a) Coil resistance	3.5.4	4.11.8.2	2.4.3	✓	✓	
b) Coil current	3.5.5	4.11.8.3	2.4.3			✓
c) Insulation resistance	3.5.1	4.11.6	2.4.1	✓	✓	✓
d) Dielectric withstanding voltage (atmospheric pressure)	3.5.2	4.11.7	2.4.2	✓	✓	✓
e) Static contact resistance	3.4.1.1	4.11.8.5.1	2.3.2	✓	✓	✓
f) Set/reset voltage	3.5.3.2	4.11.8.1.2	2.4.3	✓	✓	✓
g) Operate time	3.5.6	4.11.8.4	2.4.4	✓	✓	✓
h) Operate contact bounce time (when specified)	3.4.2.1	4.11.8.5.2	2.3.3, 2.7.2	✓	✓	✓
i) Operate contact stabilization time (when specified)	3.4.2.2	4.11.8.5.3	2.3.4, 2.7.2	✓	✓	✓
j) Coil transient suppression	3.5.7.1	4.11.8.6.1	2.4.5.1		✓	✓
k) Block integrity	3.5.7.2	4.11.8.6.2	2.4.5.2			✓
l) Neutral Screen	3.5.8	4.11.8.7		✓	✓	✓
9. Seal	3.6.3	4.11.5	2.1.5	✓	✓	✓
10. Radiographic inspection	3.6.21	4.11.23		✓	✓	✓
11. Visual inspection, external <u>4/</u>	3.6.19	4.11.1.2	2.1.3, 2.1.6, 2.2	✓	✓	✓
12. Check for lot failure		4.8		✓	✓	✓
13. Data Analysis						

**Notes to Table 12:**

1/ Inspection sample 100 % unless otherwise noted; discard all failed relays.

2/ Test sequence is optional.

3. Ground pin attachment, spacer/spreader pad attachment, lead trimming, or lead solder coating processes may be performed before, during, or after Screening and Electrical Measurements. An electrical inspection, and/or seal test, and/or external visual and mechanical inspection, as applicable, shall follow any of these processes.

4/ The header glass criteria is not applicable to relays supplied with attached spreader pads.

**Table 13. Lot Acceptance Test 3. 1/**

Inspection	Requirement in TR-HIREL-1	Test Method in TR-HIREL-1	Details and exceptions in this spec	Diode Codes		
				None	D	DD
1. Room temperature electrical measurements <u>3/</u>						
a) Coil resistance	3.5.4	4.11.8.2	2.4.3	✓	✓	
b) Coil current	3.5.5	4.11.8.3	2.4.3			✓
c) Insulation resistance	3.5.1	4.11.6	2.4.1	✓	✓	✓
d) Dielectric withstanding voltage (atmospheric pressure)	3.5.2	4.11.7	2.4.2	✓	✓	✓
e) Static contact resistance	3.4.1.1	4.11.8.5.1	2.3.2	✓	✓	✓
f) Set/reset voltage	3.5.3.2	4.11.8.1.2	2.4.3	✓	✓	✓
g) Operate time	3.5.6	4.11.8.4	2.4.4	✓	✓	✓
h) Operate contact bounce time (when specified)	3.4.2.1	4.11.8.5.2	2.3.3, 2.7.2	✓	✓	✓
i) Operate contact stabilization time (when specified)	3.4.2.2	4.11.8.5.3	2.3.4, 2.7.2	✓	✓	✓
j) Coil transient suppression	3.5.7.1	4.11.8.6.1	2.4.5.1		✓	✓
k) Block integrity	3.5.7.2	4.11.8.6.2	2.4.5.2			✓
l) Neutral Screen	3.5.8	4.11.8.7				
2. Seal	3.6.3	4.11.5	2.1.5	✓	✓	✓
3. Visual inspection, external <u>3/</u>	3.6.19	4.11.1.2	2.1.3, 2.1.6, 2.2	✓	✓	✓
4. Check for lot failure		4.8		✓	✓	✓

**Notes to Table 13:**

1/ See TR-HIREL-1, paragraph 4.10.3.3 and 2.7.2 herein.

2/ Test sequence is optional.

3/ The header glass criteria is not applicable to relays supplied with attached spreader pads.

**Table 14. Lot Acceptance Test 2. 1/**

Inspection	Requirement in TR-HIREL-1	Test method in TR-HIREL-1	Details and exceptions in this spec	Diode Codes		
				None	D	DD
<b>Group I</b>			2.7.2			
1. Life <u>1</u> /	3.6.13	4.11.20	2.3.1, 2.7.2	✓	✓	✓
2. Room temperature electrical measurements <u>2</u> /						
a) Coil resistance	3.5.4	4.11.8.2	2.4.3	✓	✓	
b) Coil current	3.5.5	4.11.8.3	2.4.3			✓
c) Insulation resistance	3.5.1	4.11.6	2.4.1	✓	✓	✓
d) Dielectric withstanding voltage (atmospheric pressure)	3.5.2	4.11.7	2.4.2	✓	✓	✓
e) Static contact resistance	3.4.1.1	4.11.8.5.1	2.3.2	✓	✓	✓
f) Set/reset voltage	3.5.3.2	4.11.8.1.2	2.4.3	✓	✓	✓
g) Operate time	3.5.6	4.11.8.4	2.4.4	✓	✓	✓
h) Operate contact bounce time (when specified)	3.4.2.1	4.11.8.5.2	2.3.3, 2.7.2	✓	✓	✓
i) Operate contact stabilization time (when specified)	3.4.2.2	4.11.8.5.3	2.3.4, 2.7.2	✓	✓	✓
j) Coil transient suppression	3.5.7.1	4.11.8.6.1	2.4.5.1		✓	✓
k) Block integrity	3.5.7.2	4.11.8.6.2	2.4.5.2			✓
l) Neutral Screen	3.5.8	4.11.8.7		✓	✓	✓
3. Visual inspection, external <u>3</u> /	3.6.19	4.11.1.2	2.1.3, 2.1.6, 2.2	✓	✓	✓
4. Check for lot failure		4.8		✓	✓	✓

See notes at end of Table.

**Table 14. Lot Acceptance Test 2 (cont'd). 1/**

Inspection	Requirement in TR-HIREL-1	Test method in TR-HIREL-1	Details and exceptions in this spec	Diode Codes		
				None	D	DD
<b>Group II</b>			<b>2.7.2</b>			
1. Intermediate current <u>1/</u>	3.6.14	4.11.14	2.3.1, 2.7.2	✓	✓	✓
2. Room temperature electrical measurements <u>2/</u>						
a) Coil resistance	3.5.4	4.11.8.2	2.4.3	✓	✓	
b) Coil current	3.5.5	4.11.8.3	2.4.3			✓
c) Insulation resistance	3.5.1	4.11.6	2.4.1	✓	✓	✓
d) Dielectric withstanding voltage (atmospheric pressure)	3.5.2	4.11.7	2.4.2	✓	✓	✓
e) Static contact resistance	3.4.1.1	4.11.8.5.1	2.3.2	✓	✓	✓
f) Set/reset voltage	3.5.3.2	4.11.8.1.2	2.4.3	✓	✓	✓
g) Operate time	3.5.6	4.11.8.4	2.4.4	✓	✓	✓
h) Operate contact bounce time	3.4.2.1	4.11.8.5.2	2.3.3, 2.7.2	✓	✓	✓
i) Coil transient suppression	3.5.7.1	4.11.8.6.1	2.4.5.1		✓	✓
j) Block integrity	3.5.7.2	4.11.8.6.2	2.4.5.2			✓
k) Neutral Screen	3.5.8	4.11.8.7		✓	✓	✓
3. Visual Inspection, external <u>3/</u>	3.6.19	4.11.1.2	2.1.3, 2.1.6, 2.2	✓	✓	✓
4. Check for lot failure		4.8		✓	✓	✓

See notes at end of Table.



**Table 14. Lot Acceptance Test 2 (cont'd). 1/**

Inspection	Requirement in TR-HIREL-1	Test method in TR-HIREL-1	Details and exceptions in this spec	Diode Codes		
				None	D	DD
<b>Group III</b>			<b>2.7.2</b>			
1. Overload (highest dc resistive load) <u>1/</u>	3.6.12	4.11.19	2.3.1, 2.7.2	✓	✓	✓
2. Room temperature electrical measurements <u>2/</u>						
a) Coil resistance	3.5.4	4.11.8.2	2.4.3	✓	✓	
b) Coil current	3.5.5	4.11.8.3	2.4.3			✓
c) Insulation resistance	3.5.1	4.11.6	2.4.1	✓	✓	✓
d) Dielectric withstanding voltage (atmospheric pressure)	3.5.2	4.11.7	2.4.2	✓	✓	✓
e) Static contact resistance	3.4.1.1	4.11.8.5.1	2.3.2	✓	✓	✓
f) Set/reset voltage	3.5.3.2	4.11.8.1.2	2.4.3	✓	✓	✓
g) Operate time	3.5.6	4.11.8.4	2.4.4	✓	✓	✓
h) Operate contact bounce time	3.4.2.1	4.11.8.5.2	2.3.3, 2.7.2	✓	✓	✓
i) Coil transient suppression	3.5.7.1	4.11.8.6.1	2.4.5.1		✓	✓
j) Block integrity	3.5.7.2	4.11.8.6.2	2.4.5.2			✓
k) Neutral Screen	3.5.8	4.11.8.7		✓	✓	✓
3. Visual Inspection, external <u>3/</u>	3.6.19	4.11.1.2	2.1.3, 2.1.6, 2.2	✓	✓	✓
4. Check for lot failure		4.8		✓	✓	✓

See notes at end of Table.

**Table 14. Lot Acceptance Test 2 (cont'd). 1/**

Inspection	Requirement in TR-HIREL-1	Test method in TR-HIREL-1	Details and exceptions in this spec	Diode Codes		
				None	D	DD
<b>Group IV</b>			<b>2.7.2</b>			
1. Mechanical life 1/	3.6.15	4.11.15	2.3.1, 2.7.2	✓	✓	✓
2. Room temperature electrical measurements 2/						
a) Coil resistance	3.5.4	4.11.8.2	2.4.3	✓	✓	
b) Coil current	3.5.5	4.11.8.3	2.4.3			✓
c) Insulation resistance	3.5.1	4.11.6	2.4.1	✓	✓	✓
d) Dielectric withstanding voltage (atmospheric pressure)	3.5.2	4.11.7	2.4.2	✓	✓	✓
e) Static contact resistance	3.4.1.1	4.11.8.5.1	2.3.2	✓	✓	✓
f) Set/reset voltage	3.5.3.2	4.11.8.1.2	2.4.3	✓	✓	✓
g) Operate time	3.5.6	4.11.8.4	2.4.4	✓	✓	✓
h) Operate contact bounce time (when specified)	3.4.2.1	4.11.8.5.2	2.3.3, 2.7.2	✓	✓	✓
i) Operate contact stabilization time (when specified)	3.4.2.2	4.11.8.5.3	2.3.4, 2.7.2	✓	✓	✓
j) Coil transient suppression	3.5.7.1	4.11.8.6.1	2.4.5.1		✓	✓
k) Block integrity	3.5.7.2	4.11.8.6.2	2.4.5.2			✓
l) Neutral Screen	3.5.8	4.11.8.7		✓	✓	✓
3. Visual Inspection, external 3/	3.6.19	4.11.1.2	2.1.3, 2.1.6, 2.2	✓	✓	✓
4. Check for lot failure		4.8		✓	✓	✓
<b>Notes to Table 14:</b>						
1/ See TR-HIREL-1, paragraph 4.10.3.3 and 2.7.2 herein.						
2/ Test sequence is optional.						
3/ The header glass criteria is not applicable.						
4. Post-life operating characteristics, operate time, and contact dynamic characteristics, as applicable, are allowed to have a 10% variance from the initial allowable values.						

**Table 15. Lot Acceptance Test 1. 1/**

Inspection	Requirement in TR-HIREL-1	Test method in TR-HIREL-1	Details and exceptions in this spec	Diode Codes		
				None	D	DD
<b>Group I</b>			<b>2.7.2</b>			
1. Thermal shock	3.6.4	4.11.9		✓	✓	✓
2. Shock (specified pulse)	3.6.5	4.11.10	2.8	✓	✓	✓
3. Vibration (sinusoidal and random)	3.6.6	4.11.11	2.8	✓	✓	✓
4. Terminal strength	3.6.8	4.11.21	2.8	✓	✓	✓
5. Room temperature electrical measurements <u>2</u> /						
a) Coil resistance	3.5.4	4.11.8.2	2.4.3	✓	✓	
b) Coil current	3.5.5	4.11.8.3	2.4.3			✓
c) Insulation resistance	3.5.1	4.11.6	2.4.1	✓	✓	✓
d) Dielectric withstanding voltage (atmospheric pressure)	3.5.2	4.11.7	2.4.2	✓	✓	✓
e) Static contact resistance	3.4.1.1	4.11.8.5.1	2.3.2	✓	✓	✓
f) Set/reset voltage	3.5.3.2	4.11.8.1.2	2.4.3	✓	✓	✓
g) Operate time	3.5.6	4.11.8.4	2.4.4	✓	✓	✓
h) Operate contact bounce time (when specified)	3.4.2.1	4.11.8.5.2	2.3.3, 2.7.2	✓	✓	✓
i) Operate contact stabilization time (when specified)	3.4.2.2	4.11.8.5.3	2.3.4, 2.7.2	✓	✓	✓
j) Coil transient suppression	3.5.7.1	4.11.8.6.1	2.4.5.1		✓	✓
k) Block integrity	3.5.7.2	4.11.8.6.2	2.4.5.2			✓
l) Neutral Screen	3.5.8	4.11.8.7		✓	✓	✓
6. Seal	3.6.3	4.11.5	2.1.5	✓	✓	✓
7. Visual inspection, external <u>3</u> /	3.6.19	4.11.1.2	2.1.3, 2.1.6, 2.2	✓	✓	✓
8. Check for lot failure		4.8		✓	✓	✓

See notes at end of Table.

**Table 15. Lot Acceptance Test 1 (cont'd). 1/**

Inspection	Requirement in TR-HIREL-1	Test method in TR-HIREL-1	Details and exceptions in this spec	Diode Codes		
				None	D	DD
<b>Group II</b>			<b>2.7.2</b>			
1. Coil life	3.6.9	4.11.22	2.8	✓	✓	✓
2. Acceleration	3.6.16	4.11.16				
3. Resistance to solvents	3.6.17	4.11.17	2.8	✓	✓	✓
4. Resistance to soldering heat	3.6.10	4.11.18	2.8	✓	✓	✓
5. Room temperature electrical measurements <u>2/</u>						
a) Coil resistance	3.5.4	4.11.8.2	2.4.3	✓	✓	
b) Coil current	3.5.5	4.11.8.3	2.4.3			✓
c) Insulation resistance	3.5.1	4.11.6	2.4.1	✓	✓	✓
d) Dielectric withstanding voltage (atmospheric pressure)	3.5.2	4.11.7	2.4.2	✓	✓	✓
e) Static contact resistance	3.4.1.1	4.11.8.5.1	2.3.2	✓	✓	✓
f) Set/reset voltage	3.5.3.2	4.11.8.1.2	2.4.3	✓	✓	✓
g) Operate time	3.5.6	4.11.8.4	2.4.4	✓	✓	✓
h) Operate contact bounce time (when specified)	3.4.2.1	4.11.8.5.2	2.3.3, 2.7.2	✓	✓	✓
i) Operate contact stabilization time (when specified)	3.4.2.2	4.11.8.5.3	2.3.4, 2.7.2	✓	✓	✓
j) Coil transient suppression	3.5.7.1	4.11.8.6.1	2.4.5.1		✓	✓
k) Block integrity	3.5.7.2	4.11.8.6.2	2.4.5.2			✓
l) Neutral Screen	3.5.8	4.11.8.7		✓	✓	✓
6. Visual inspection, external <u>3/</u>	3.6.19	4.11.1.2	2.1.3, 2.1.6, 2.2	✓	✓	✓
7. Check for lot failure		4.8		✓	✓	✓
<b>Notes to Table 15:</b>						
1/ See TR-HIREL-1 paragraph 4.10.3.3 and 2.7.2 herein.						
2/ Test sequence is optional.						
3/ The header glass criteria is not applicable.						
4 Post-life operating characteristics, operate time, and contact dynamic characteristics, as applicable, are allowed to have a 10% variance from the initial allowable values.						

**5. GENERAL NOTES.**

- a) Reverse polarity on the coil terminals of relays supplied with internal diode for coil transient suppression (without polarity reversal protection) will destroy the diode.
- b) When used in applications at high level loads, surge current protection is recommended.

**Appendix A. Mounting and Termination Variants.**

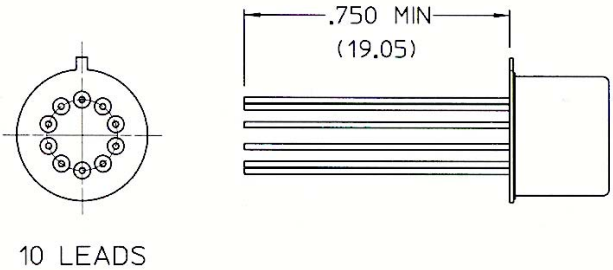
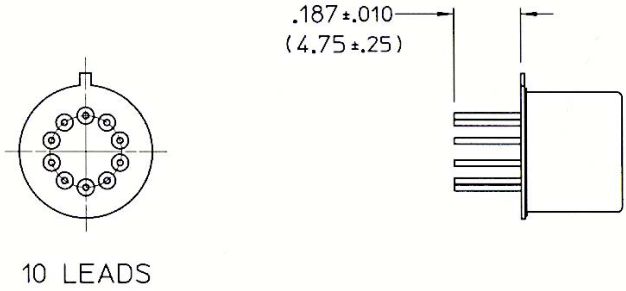
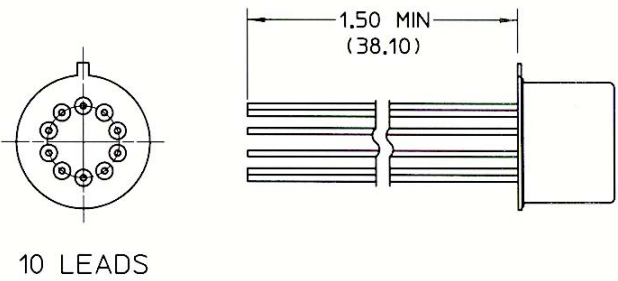
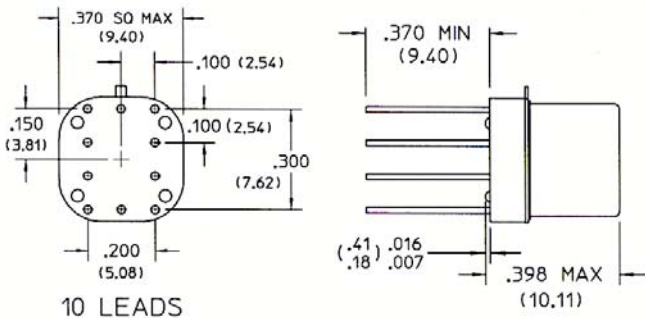
Mounting	Termination	Configuration
No Code	No Code G Q	 <p>.750 MIN (19.05)</p> <p>10 LEADS</p>
No Code	S SG SQ	 <p>.187 ± .010 (4.75 ± .25)</p> <p>10 LEADS</p>
No Code	W WG WQ	 <p>1.50 MIN (38.10)</p> <p>10 LEADS</p>
M	No Code G Q	 <p>.370 50 MAX (9.40)</p> <p>.100 (2.54)</p> <p>.150 (3.81)</p> <p>.200 (5.08)</p> <p>.100 (2.54)</p> <p>.300 (7.62)</p> <p>.370 MIN (9.40)</p> <p>(.41) .016 (.18) .007</p> <p>.398 MAX (10.11)</p> <p>10 LEADS</p>

**Appendix A. Mounting and Termination Variants (Continued).**

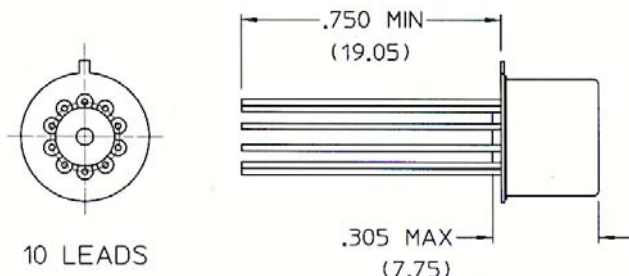
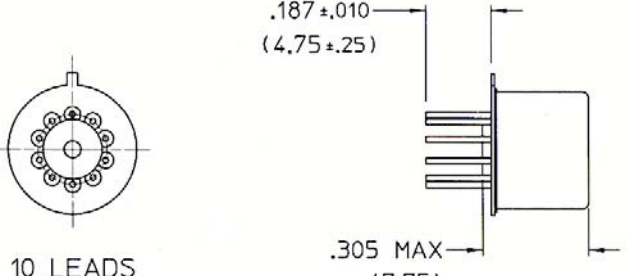
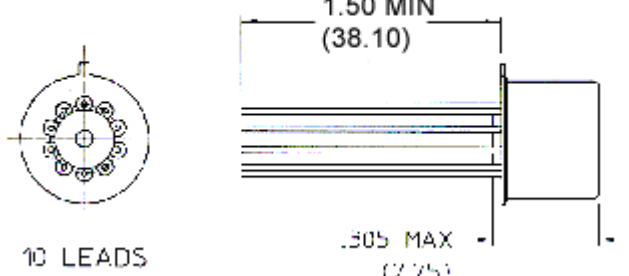
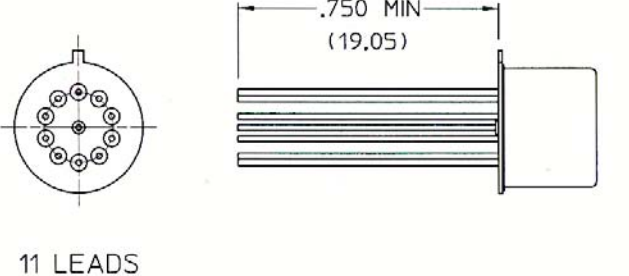
Mounting	Termination	Configuration
M4	No Code G Q	 <p>10 LEADS</p>
M4	S SG SQ	 <p>10 LEADS</p>
M4	W WG WQ	 <p>10 LEADS</p>
X	No Code G Q	 <p>11 LEADS</p>

**Appendix A. Mounting and Termination Variants (Continued).**

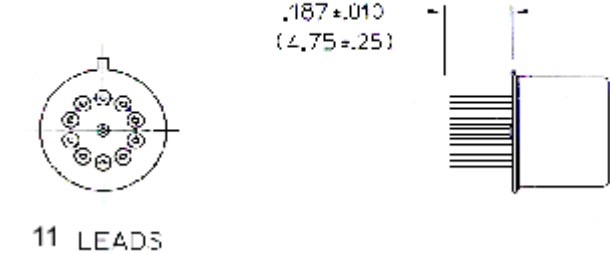
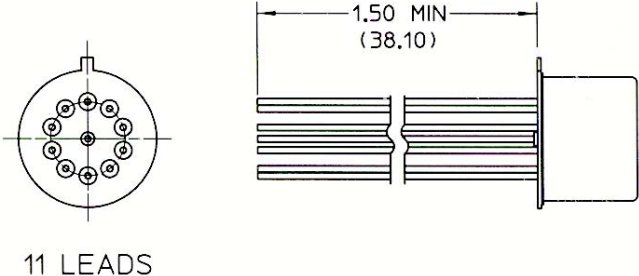
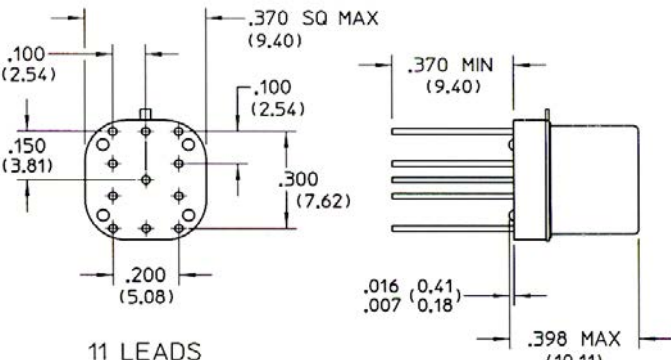
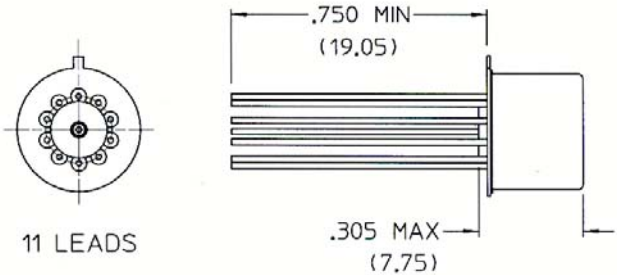
Mounting	Termination	Configuration
X	S SG SQ	 <p>11 LEADS</p>
X	W WG WQ	 <p>11 LEADS</p>
XM3	No Code G Q	 <p>11 LEADS</p>
XM4	No Code G Q	 <p>11 LEADS</p>

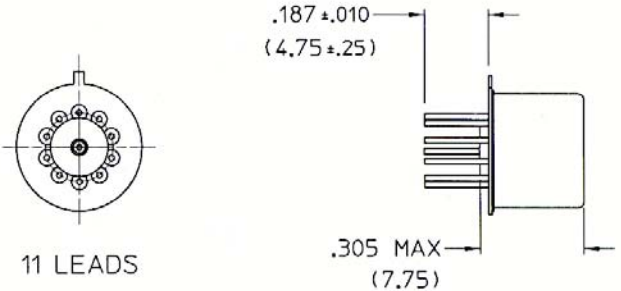
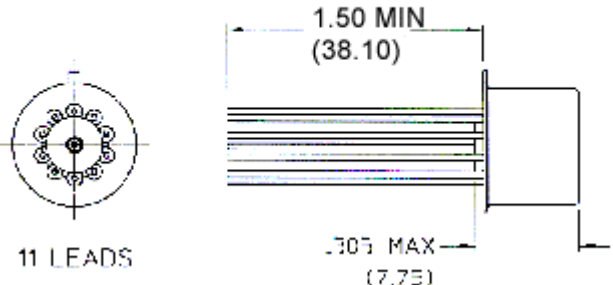

**Appendix A. Mounting and Termination Variants (Continued).**

Mounting	Termination	Configuration
XM4	S SG SQ	 <p>11 LEADS</p>
XM4	W WG WQ	 <p>11 LEADS</p>

**Appendix B. Document Change History.**

<b>Issue or Amendment No.</b>	<b>Date of Issue</b>	<b>Reference and Change Description</b>	<b>Change Notice No.</b>
Issue 1	27 Feb 2001	Official Release	26633
Issue 2	18 June 2013	Correct Typographical Error	30439
Issue 3	27 May 2015	Added Acceleration Test and Data Review	30358