



**SURFACE MOUNT
HIGH REPEATABILITY
SPDT, BROADBAND 18 GHZ
40GBPS
MAGNETIC-LATCHING RF RELAY**



SERIES	RELAY TYPE
GRF121	RF Magnetic-Latching, SPDT, Common Coil Negative, Surface Mount Relay
GRF121R	RF Magnetic-Latching, SPDT, Common Coil Positive, Surface Mount Relay

DESCRIPTION

The ultraminiature Series GRF121/GRF121R is designed to provide a practical surface-mount switching solution with RF performance and repeatability to 18GHz. The GRF121/GRF121R improves on Teledyne Relays' heritage of miniature RF relays by incorporating a precision transmission line structure in the internal construction of the contact system. GRF121/GRF121R relays feature a unique ground shield to facilitate surface mounting and to extend the frequency range when compared to through-hole solutions.

These relays are designed for use in RF attenuators, RF switch matrices, high frequency spread spectrum radios, ATE, and other applications that require dependable high frequency signal fidelity and performance. The magnetic-latching GRF121/GRF121R is suitable for applications where power budget is restricted. The relays can be operated with a short duration pulse. After the contacts have transferred, no external holding power is required.

The GRF121/GRF121R features:

- High Repeatability
- Wide Bandwidth Performance
- Higher Isolation Between Each Signal Path
- Metal Enclosure for EMI Shielding
- High Isolation Between Control and Signal Paths
- High Resistance to ESD

The unique construction features and manufacturing techniques provide excellent robustness for environmental extremes and overall reliability:

- Minimum mass components and welded construction provide maximum resistance to shock and vibration
- Advanced cleaning techniques provide maximum assurance of internal cleanliness
- Gold-plated precious metal alloy contacts ensure reliable switching
- Hermetic Seal
- RoHS Compliant

ENVIRONMENTAL AND PHYSICAL SPECIFICATIONS

Temperature (Ambient)	Storage	-55°C to +125°C
	Operating	-55°C to +85°C
Vibration (Note 3)		10 g's, 10 to 3000 Hz
Shock (Note 3)		30 g's, 6ms half sine
Enclosure		Hermetically sealed

Series GRF121/GRF121R

SPDT Magnetic-Latching
DC-18GHz RF Relay
40Gbps



**TELEDYNE
RELAYS**
Everywhereyoulook™

GENERAL ELECTRICAL SPECIFICATIONS (@ 25°C)

Contact Arrangement	1 Form C (SPDT), with open contact grounded to case
Rated Duty	Continuous
Contact Load Rating	Resistive: 0.25A @ 28Vdc
Contact Life Rating	3,000,000 cycles typical at low level
Coil Operating Power	GRF121-5/GRF121R-5: 410mW typical @ nominal rated voltage GRF121-12/GRF121R-12: 290mW typical @ nominal rated voltage
Switching Time	7.0 msec. max. (2 msec operate time, 5 msec bounce time)
Minimum Operate Pulse	6.0 msec width at rated voltage
Insulation Resistance	1,000MΩ min. between mutually isolated terminals
Dielectric Strength	350 Vrms (60Hz) @ Atmospheric Pressure
Propagation Delay	54-60 ps typical

DETAILED ELECTRICAL SPECIFICATIONS (@25°C)

BASE PART NUMBERS	GRF121-5/GRF121R-5	GRF121-12/GRF121R-12
Coil Voltage, Nominal (Vdc)	5.0	12.0
Coil Resistance (Ohms ±20%)	61	500
Pick-up Voltage, Max (Vdc) (Note 5)	4.3	10.4

Part Numbering System (Note 4)

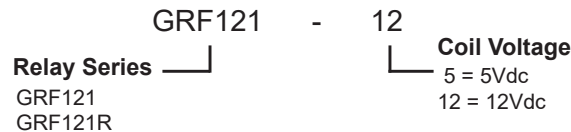

NOTES

1. Characteristics shown as "typical" are based on available data and are best estimates. No ongoing verification tests are performed.
2. Unless otherwise specified, parameters are initial values.
3. Relay contacts will exhibit no chatter in excess of 10 μsec or transfer in excess of 1 μsec.
4. Relay leads are gold plated with a typical thickness of 25-40 μin. Ground shield is gold plated with a typical thickness of 10-30 μin.
5. Operate voltage at less than the specified minimum may result in unreliable operation.
6. Relay temperature during soldering shall not exceed 250°C, and reflow temperature shall not exceed 250°C, 3 passes, 1 minute each.

TYPICAL RF CHARACTERISTICS (See RF Notes)

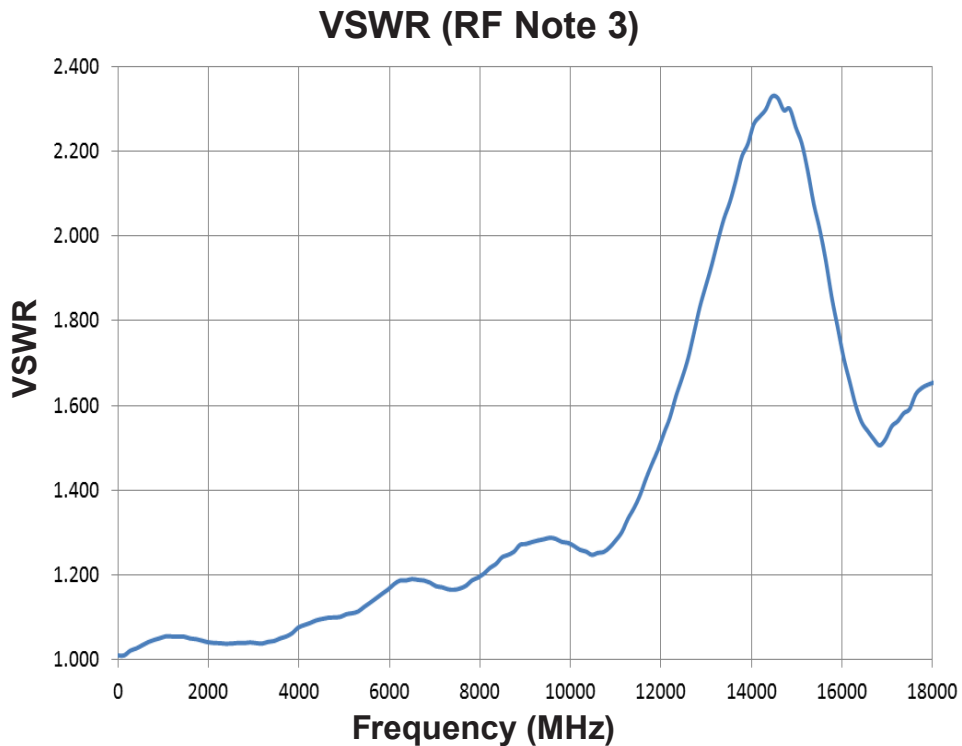
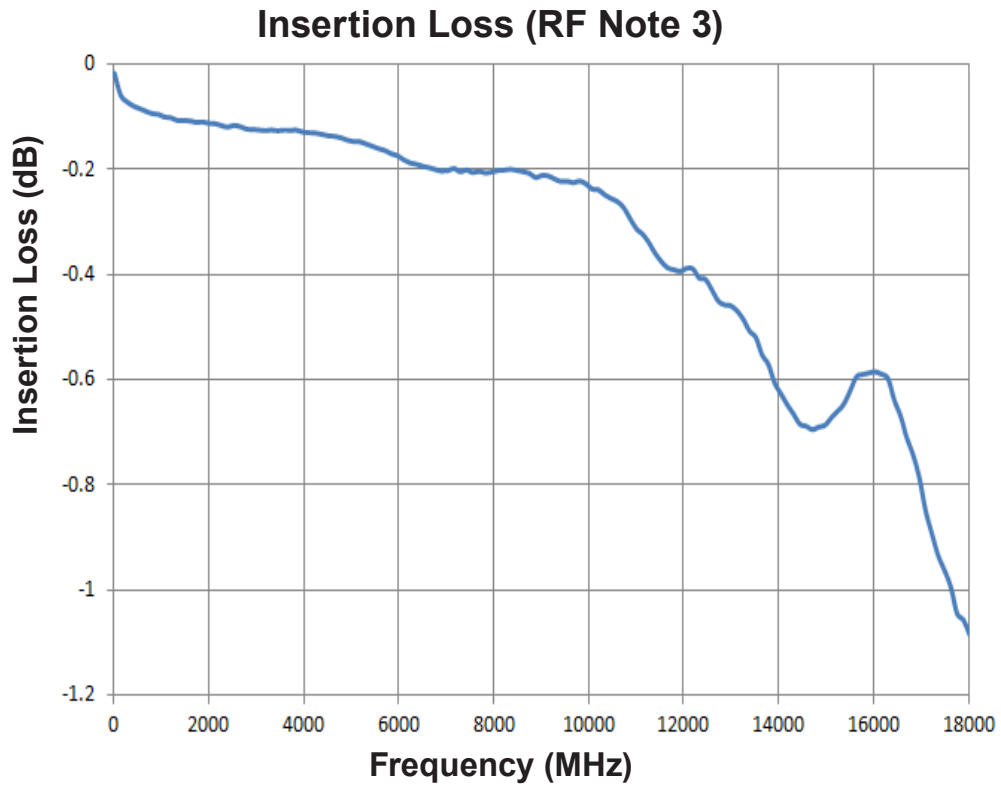

Series GRF121/GRF121R

SPDT Magnetic-Latching
DC-18GHz RF Relay
40Gbps



**TELEDYNE
RELAYS**
Everywhere you look™

TYPICAL RF CHARACTERISTICS (See RF Notes)

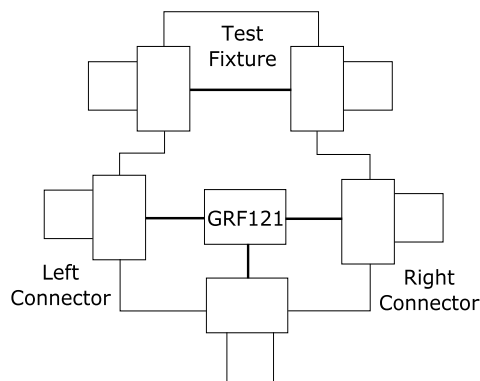
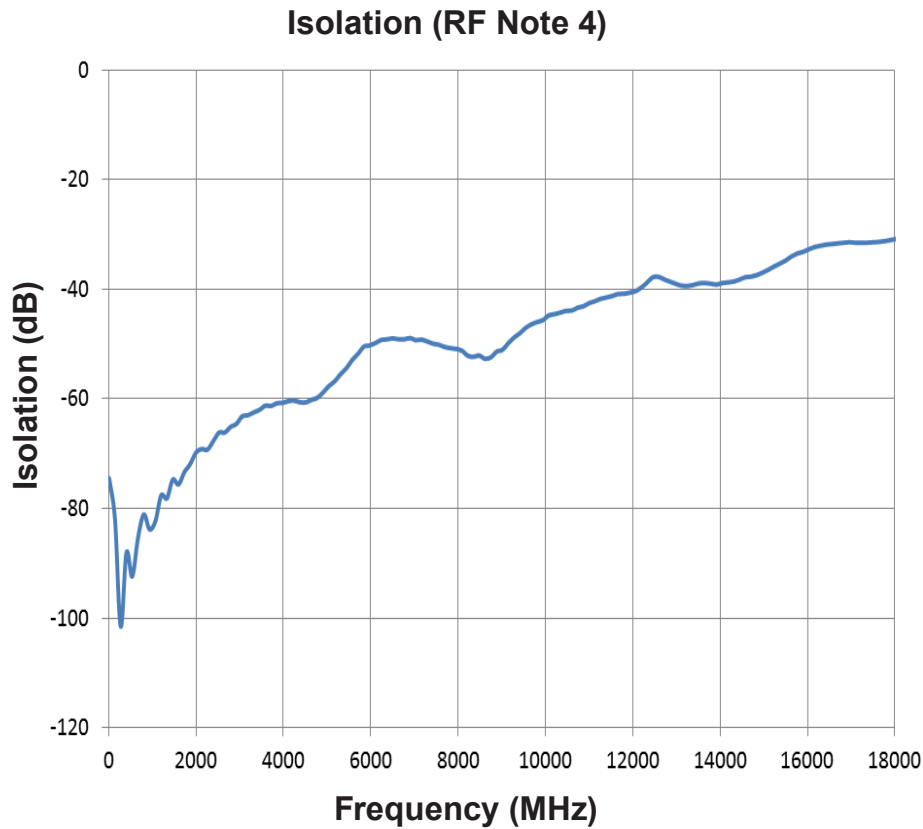

GRF121/GRF121R Test Evaluation Board

RF NOTES

- Test conditions:
 - Fixture: .031" copper clad, gold plated, reinforced Rogers Corporation 4350B High Frequency Laminate with SMA connectors.
 - Room ambient temperature.
 - Unused Terminals were terminated with 50-ohm load.
 - Contact signal level: -10 dBm.
 - No. of test samples: 2.
- Data presented herein represents typical characteristics and is not intended for use as specification limits.
- Data is the average from readings taken on all closed contacts.
- Data is the average from readings taken on all open contacts.
- Test fixture effect de-embedded from frequency response data.

TYPICAL SIGNAL INTEGRITY CHARACTERISTICS

GRF121/GRF121R @ 16Gbps

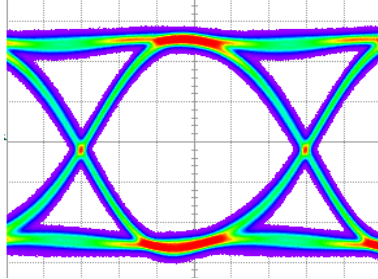

Bit Rate	Eye Height	Eye Width	Jitter _{P,P}
16 Gbps	203 mV	49.92 ps	4.99 ps

Reference @ 16Gbps

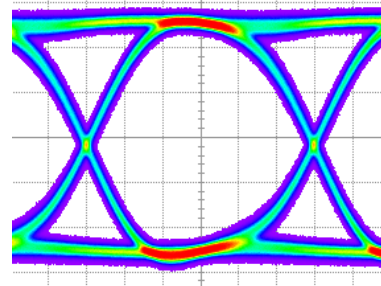

GRF121/GRF121R @ 28Gbps

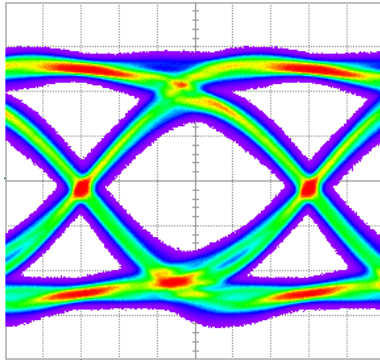

Bit Rate	Eye Height	Eye Width	Jitter _{P,P}
28 Gbps	139.2 mV	21.6 ps	5.89 ps

Reference @ 28Gbps

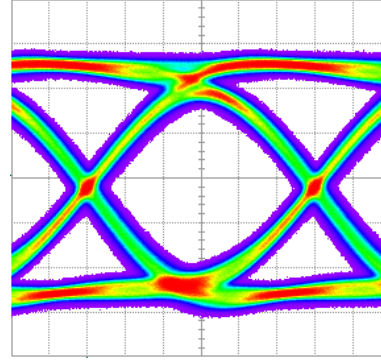

GRF121/GRF121R @ 40Gbps

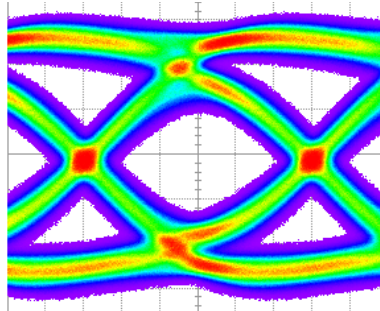

Bit Rate	Eye Height	Eye Width	Jitter _{P,P}
40 Gbps	95 mV	13.34 ps	8.73 ps

Reference @ 40Gbps

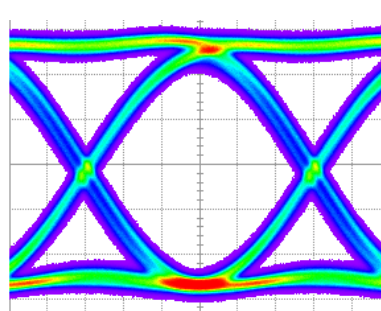

- **Pattern Generator Settings**
- 40 Gbps Random Pulse Pattern Generator
- $2^{31} - 1$ PRBS signal
- PRBS output of 500 mV_{P,P} (nominal)
- RF PCB effect (negligible) not removed from measurement
- Data shown is typical of both contacts.

Series GRF121/GRF121R

SPDT Magnetic-Latching
DC-18GHz RF Relay
40Gbps



**TELEDYNE
RELAYS**
Everywhereyoulook™

OUTLINE DIMENSIONS

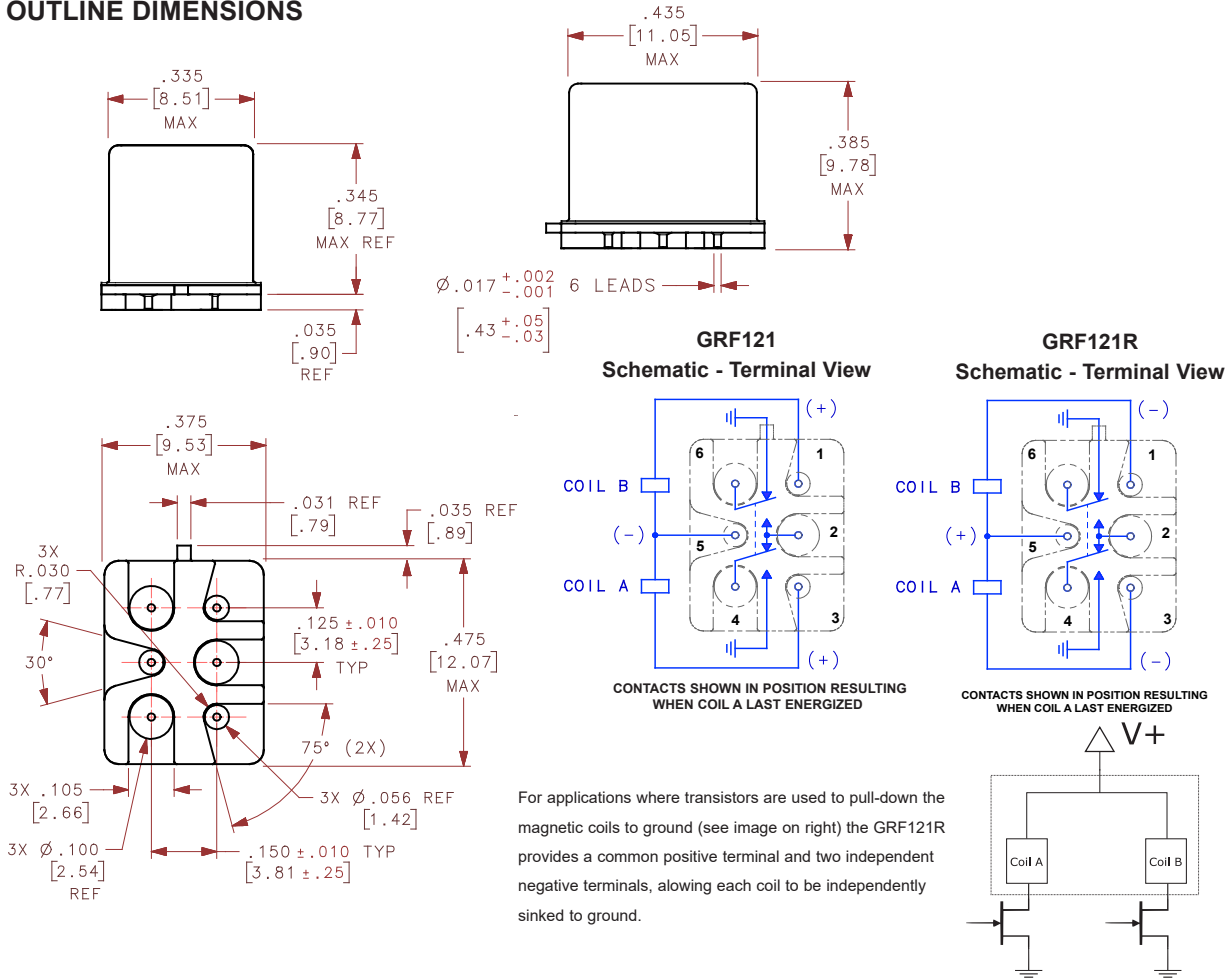

RECOMMENDED SOLDER STENCIL

