

A 1-Watt Ku-band Power Amplifier MMIC using Cost-effective Organic SMD Package

A. Bessemoulin¹, M. Parisot¹, P. Quentin¹, C. Saboureau², M. van Heijningen³, J. Priday⁴

¹United Monolithic Semiconductors S.A.S, route départementale 128 – BP46, F-91401 Orsay Cedex – France

²IRCOM CNRS-UMR 66-15, 123 avenue Albert Thomas, F-87100 Limoges, France

³TNO Physic and Electronic Laboratory, Oude Waalsdorperweg 63, 2597 AK The Hague – The Netherlands

⁴Labtech Ltd., Broadaxe Business Park, Presteigne Powys, LD8 2UH – United Kingdom

email: alexandre.bessemoulin@ieec.org – Ph. (+33) 1 69 33 05 46 – Fax. (+33) 1 69 33 05 52

Abstract — This paper presents the design and performance of a compact 1-Watt Ku-band power amplifier MMIC implemented in a novel microwave organic power package, compatible with SMD assembly lines. Due to the use of simple materials, like RO4003 substrate and copper, it allows significant cost reduction for RF module assembly. The packaged amplifier MMIC demonstrates as well, very high-gain, as high as 32 dB at Ku-band, under very stable conditions, and more than 1.25-Watt continuous-wave output power (>31 dBm).

I. INTRODUCTION

Despite of today's economic situation in telecommunications, recent growths in VSAT (Very Small Aperture Terminals) market have created a demand for low cost high power amplifier solutions in the Ku- and Ka-bands. Furthermore, the trend of microwave and millimeter wave ICs is now toward cost effective packaged products, compatible with Surface Mount Device (SMD) assembly lines [1,2]. Module manufacturers have indeed to reduce their assembly cost to a minimum, to be competitive, increasing further the pressure on MMIC manufacturers. Although chip size reduction, and the use of multifunction MMICs help to reduce the cost, the assembly contribution on module level is however still significant. This is especially due to the expensive pick- and place equipments, bonding tools, clean room installation, etc.

However, one of the biggest challenges for packaged high power microwave amplifiers, is the thermal management at the lower cost. Among the number of existing packages available for microwave devices like flange mount-, ball grid array-, quad flat packages (micro leadframe or QFN), ceramic- or silicon packages, one promising approach is the organic PCB (Printed Circuit Board) power package technology developed by Labtech. within the European SMACKS project. The principle of such a package is described in Fig. 1. The MMIC is attached onto a thickened copper slug (120 μm), within a cavity made in low-cost 8-mils RO4003 substrate (203 μm). The electrical interconnects are realized with gold bond wires connecting the MMIC pads to feed lines on the package frontside, themselves connected to the package leads, through the package substrate by mean of RF vias. After covering with a lid, the device can be mounted, by a reflow soldering technique for instance.

From the microwave and thermal point of view, the advantages of this package are the short interconnects, that push away the maximum usable frequency, and the exposed ground, which exhibits very low parasitic inductance, and low thermal resistance due to the use of a slug enhanced by electrolytic copper plating.

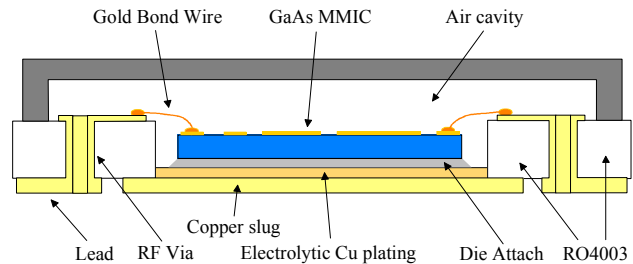

Fig. 1: Principle of the microwave organic SMD power package.

This paper presents and demonstrates, the integration and performance of a high gain-, high power Ku-band MMIC, under ultra stable operation, in such SMD power package.

II. HIGH GAIN KU-BAND POWER MMIC

A. High Power Amplifier MMIC

The compact high power amplifier MMICs (Fig. 2) are fabricated with the UMS selective double-recess / double-side-doped power PHEMT process, using 0.25- μm Aluminum T-gates on 4'' wafers (PPH25x). The MMICs are realized on 70- μm substrate, with two gold metallization levels, 30 Ω/\square TaN thin film resistors, 250 pF/mm² Silicon Nitride MIM capacitors, airbridges, and 20- μm via-holes under every FET sources, resulting in high gain and excellent thermal properties. Typical bare die HPA MMIC characteristics are summarized in Table I, and the measured small signal S-parameters are shown in Fig. 3. For cost effective MMIC process, this 32-dBm HPA MMIC device was optimized for compactness. The amplifier (Fig. 2) consists of four 1-mm gate width devices driven by three successive stages, having a gate width ratio of 2:1, and a chip size of only 2.37 \times 1.39 mm² (3.3 mm²). Such a compact chip

size for a 4-stage HPA MMIC, was achieved thanks to the key design approaches described in [3]: Compact matching topologies that occupy as much of the remaining GaAs area as possible were considered prior to circuit optimization. Based on the optimum power transfer, full channel modulation and load line approaches for all stages, rigorous design and layout methods were considered in the optimization of power, gain and bandwidth. The matching networks (input, interstages and output) were realized using MIM capacitively loaded transmission lines, that allow flexible impedance matching and size reduction.

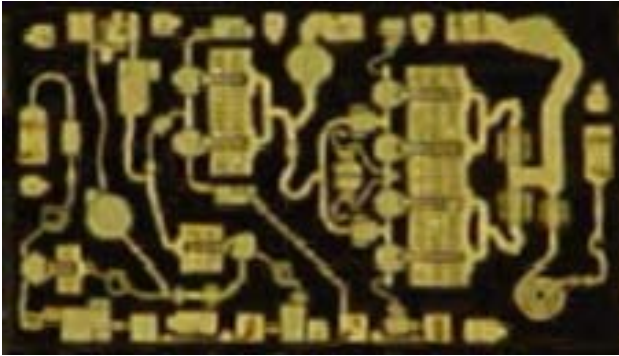

Fig. 2: Chip photograph of the 4-stage 1-Watt Ku-band HPA MMIC (chip size is $2.37 \times 1.39 \text{ mm}^2$).

Stability of this HPA was also a primary concern. K-factor and the S-probe analysis in combination with large on-chip bypassing capacitors and resistive loading were used to prevent low frequency-, parametric- and odd-mode oscillations, resulting in the unconditional stability of the amplifier above the PHEMT device f_{max} .

TABLE I.
ELECTRICAL PARAMETERS OF THE 1-WATT HPA MMIC.

| Parameters | Typical values |
|-------------------------------------|----------------|
| Frequency range (GHz) | 13-16 GHz |
| Linear Gain (dB) | 32 dB |
| Output power $P_{1\text{dB}}$ (dBm) | 31 dBm |
| Output power P_{sat} (dBm) | 32 dBm |
| Operating quiescent bias | 8 V / 750 mA |

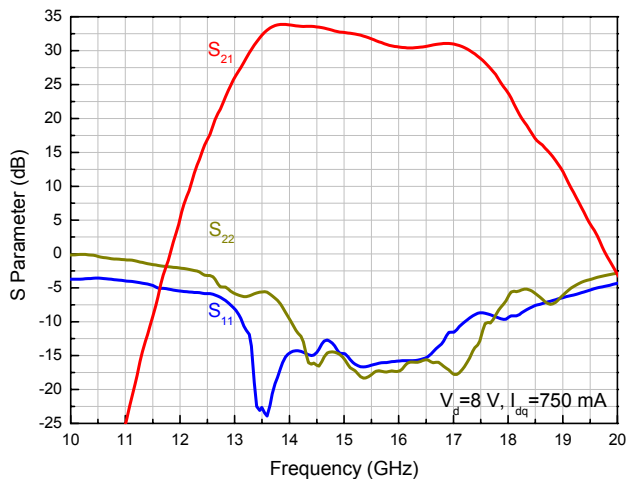

Fig. 3: Measured small signal gain, input- and output return loss versus frequency of the bare die HPA MMIC in JIG test fixture, at $V_d=8 \text{ V}$ and $I_{dq}=750 \text{ mA}$.

B. SMD power package

The HPA MMIC is mounted into the organic power package, with a thermal adhesive, as depicted in Fig. 4a, and Fig. 4b. Loss and parasitic effects are minimized by using appropriate MMIC dimensions with respect to the air cavity, and short double bond-wires, excluding the necessity of any compensation circuit for this frequency range. In order to ensure the low frequency stability of the HPA MMIC, additional 120-pF decoupling capacitors are integrated into the package, then connected to the DC bias pad (up and down in Fig. 4). It is worth mentioning that this device is stable under any bias conditions of the $I_{ds}(V_{ds})$ characteristic. Thermal management of packaged HPA MMIC is essential to ensure device lifetime and reliability. This is especially mandatory for VSAT HPAs, operating in continuous-wave mode near saturation. Thermal analysis, using closed forms derived from process characterization over temperature, as well as 3D thermal simulations have been performed, demonstrating that at worst case conditions of $+85 \text{ }^\circ\text{C}$ base-plate temperature, with or without RF drive, the peak channel temperature is maintained below the absolute limit of $175 \text{ }^\circ\text{C}$ for this GaAs power PHEMT process.

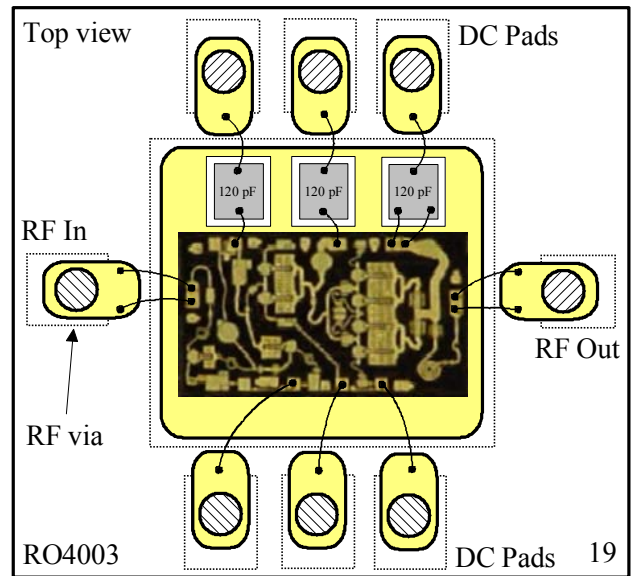

Fig. 4-a: Schematic arrangement of the 1-Watt HPA MMIC in the SMD organic power package.

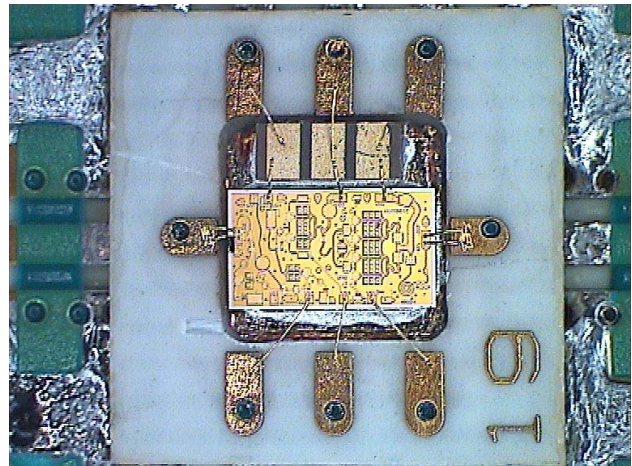

Fig. 4-b: Microphotograph of the 1-Watt HPA MMIC in the SMD organic power package (package size is $4.0 \times 4.0 \text{ mm}^2$).

III. MEASURED PACKAGED MMIC PERFORMANCE AND DISCUSSION

A. Substrate carrier design

To ease the characterization process, an evaluation board has been designed (Fig.5). The packaged MMIC amplifiers are soldered onto a carrier made in 8-mil thick RO4003 substrate from Rodgers *Inc.* (203 μm). In order to reduce input-, output mismatches, as well as substrate coupling, the carrier was designed with grounded coplanar waveguides, as feed transmission lines (GCPW or “quasi-microstrip” coplanar lines, as shown in Fig. 5, and depicted in Fig. 6).

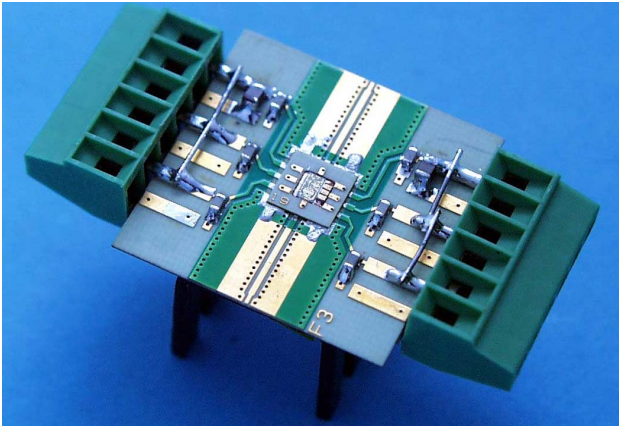

Fig. 5: SMD packaged 1-Watt HPA MMIC implemented on the RO4003 power test fixture.

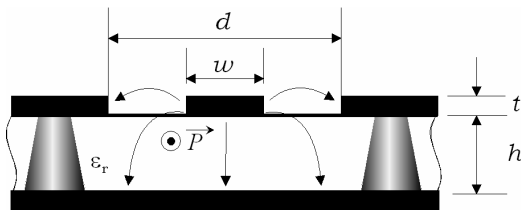

Fig. 6: Cross section of grounded coplanar waveguide (GCPW) transmission line, as used in the power test fixture of Fig. 5.

The packaged HPA is also attached to the carrier by mean of reflow soldering, specifically onto an array of via-holes, placed under the exposed pad. This array is designed in order to minimize the parasitic inductance to ground of the mounted packaged IC, when using microstrip launching. Indeed, this parasitic inductance can have a significant impact on stability for such high gain devices (i.e. more than 34-dB gain at 14 GHz). Yet another object of the via-hole array, is obviously to ensure a very good thermal transfer to the heat sink.

As shown in Fig. 5, additional bias decoupling SMD capacitors of 10-nF, and 1 μF are externally mounted, to ensure very low frequency stability, and stable DC bias. In the present configuration, all drains, and gates are respectively connected together, in order to reduce the number of bias supplies.

Finally, the evaluation board can be tested conveniently with a Wiltron[®] (e.g. model 3680V) or Continental Microwave[®] test fixtures. Furthermore, it can be noticed that the layout implementation is very simple, and can be easily implemented in the final radio module.

B. Measured performance

All the measured data reported hereafter were performed at room temperature (i.e. $T_a=20^\circ\text{C}$). The loss of the coaxial- to microstrip transition, and the feed lines, were corrected down to the package RF ports, so that the measured data reflect only the *packaged* HPA MMIC.

Fig. 7 shows the S-parameters of the packaged HPA, measured with a scalar network analyzer in the 10- to 20 GHz frequency band. At $V_d=8\text{ V}$, and for a total quiescent bias current of $I_{dq}=750\text{ mA}$, the gain (S_{21}) is greater than 30 dB, from 13- to 16 GHz (34.5-dB peak at 14 GHz). Over the same bandwidth, the amplifier exhibits very good input- (S_{11}), and output return loss (S_{22}), typically well below -10 dB. The reverse isolation (S_{12} , not shown) is under the measurement setup sensitivity, let better than 35 dB. These results agree well, with those obtained with a bare die MMIC, measured in UMS JIG test fixture (Fig. 7, dashed line). Above 16 GHz, the sharper gain roll-off is attributed to the longer bond wire at the output RF pad of the MMIC, and the small detuning effect of the packaged HPA toward lower frequencies.

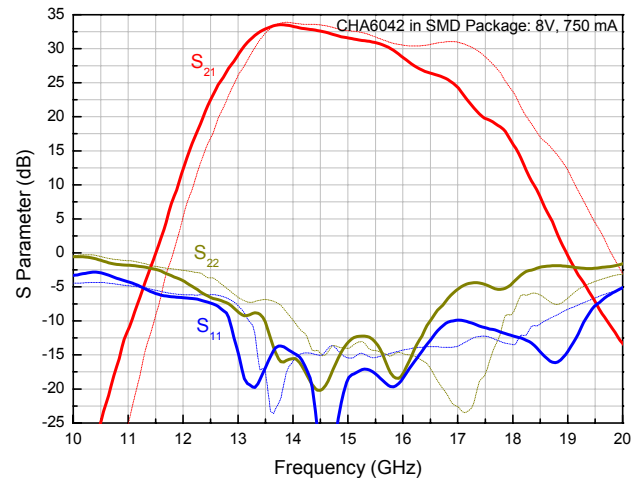

Fig. 7: Measured gain (S_{21}), input- (S_{11}) and output return (S_{22}) loss of the “fixtured” packaged MMIC at $V_d=8\text{ V}$ and $I_{dq}=750\text{ mA}$ (dashed lines: bare die HPA MMIC).

The packaged HPA were also characterized under large signal operation, with an in-house scalar power measurement system in 50- Ω . Fig. 8 shows the measured output power versus continuous-wave input power (CW), at 13.5-, 14-, and 14.5 GHz. At $V_{ds}=8\text{ V}$, and for a total quiescent bias current of 750-mA, the output power near saturation is above 30.5 dBm (1.1 Watt), in the 13.5-14.5 GHz, with still more than 30-dB associated gain. Such an high gain enables to relax significantly the power-, and gain specifications of the driver amplifier stage in the Ku-band power line-up; which helps further to reduce the cost of the VSAT radio. Finally, Fig. 9 shows the measured output power at saturation, as a function of the frequency under continuous wave drive: at $V_d=8\text{ V}$, and for a total supply current of 850 mA (750-mA quiescent bias current), the saturated output power is above 1 Watt between 13.25- and 15.75 GHz, and above 31-dBm (>1250 mW) in the 13.75-15 GHz (Ku-band VSAT frequency band).

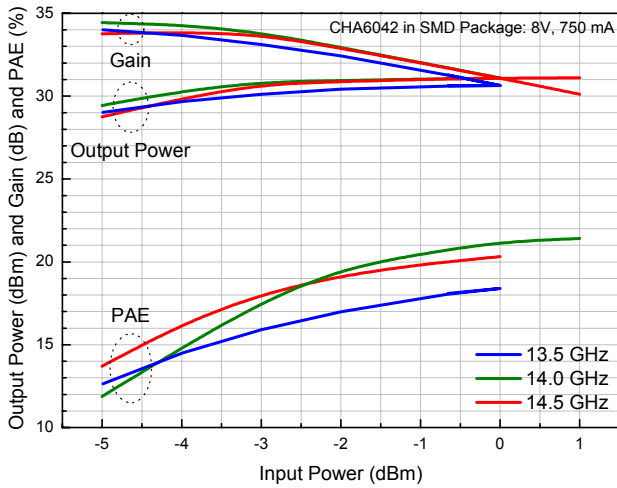

Fig. 8: Measured CW output power, gain, and PAE versus input power, of the Ku-band packaged high power amplifier at 13.5-, 14- and 14.5 GHz ($V_d=8\text{ V}$, $I_{dq}=750\text{ mA}$)

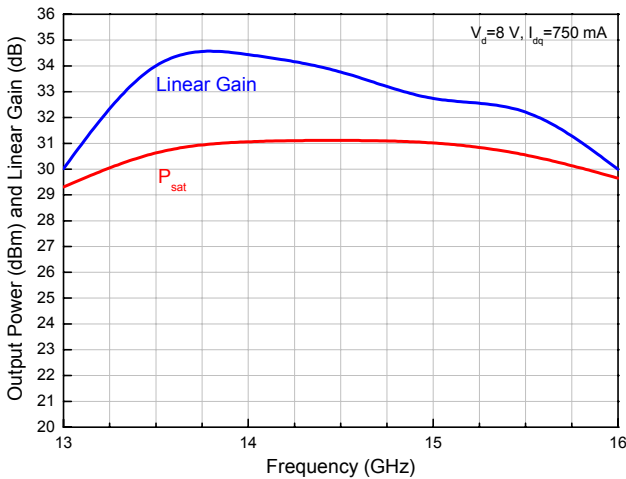

Fig. 9: Measured CW output power, and linear gain of the Ku-band packaged HPA (13-16 GHz, $V_d=8\text{ V}$, $I_{dq}=750\text{ mA}$).

V. CONCLUSION

The performance of a compact 1-Watt Ku-band power amplifier MMIC implemented in a novel microwave power package, compatible with SMD assembly lines, has been presented. Due to the use of simple materials, like RO4003 organic substrate and copper, this package is very competitive, and allows significant cost reduction for RF module assembly, with very good thermal properties. The packaged amplifier MMIC demonstrates very high-gain, as high as 34 dB at Ku-band, under ultra-stable conditions, and more than 1.25-Watt continuous-wave output power ($>31\text{ dBm}$).

ACKNOWLEDGEMENTS

Part of this work was developed within the European SMACKS project, funded by the Information Society Technologies (EC contract n° IST-2000-30060). The authors wish also to thanks J.R. Bois, for fruitful discussion, and P. Chaumaz, for performing the power measurement at Ku-band.

REFERENCES

- [1] K. Beilenhoff, A. Bessemoulin, P. Quentin, S. Tranchant, O. Vaudescal, M. Parisot, H. Daembkes, "Full 26-GHz MMIC Chipset for Telecom Applications in SMD-Type Packages", in Proc. of the Gallium Arsenide & Other Semiconductors Application Symposium (GAAS 2002), pp. 331-334, Milan, Italy. September 2002.
- [2] A. Bessemoulin, M. Parisot, M. Camiade, "1-Watt Ku-band Power Amplifier MMICs using Low-cost Quad-Flat Plastic Package", in IEEE Int. Microwave Symposium Dig., pp. 473-476, Fort Worth, TX-USA. June 2004.
- [3] A. Bessemoulin, J. Dishong, G. Clark, D. White, P. Quentin, H. Thomas, D. Geiger, "1-Watt Broad Ka-band Ultra Small High Power Amplifier MMICs Using 0.25- μm GaAs PHEMTs", 2002 IEEE GaAs IC Symposium, pp.40-43. Monterey, CA-USA. October 2002.
- [4] Cha6042-99F, product datasheet, United Monolithic Semiconductors, <http://www.ums-gaas.com/>, Oct. 2002.