



Voltage-Controlled AGC Amplifier 10 to 1000 MHz

Technical Data

AGC-1053

Features

- **Frequency Range: 10 to 1000 MHz**
- **MODAMP Silicon Monolithic Gain Stages**
- **AGC Range: 35 dB (Typ)**
- **0 to 5 V Control Voltage**

Applications

- **Open or Closed Loop Gain Control**
- **Receiver Output Gain Control**
- **Transmitter Output Leveling Control**

Description

The AGC-1053 combines three MMIC RF amplifiers with 22 dB (typ) gain, and PIN diodes with 0 to +5 VDC control voltage for gain control. The 1053 has blocking capacitors which couple the RF signal through the amplifier, and bypass capacitors to filter the bias voltage line.

Pin Configuration TO-8F

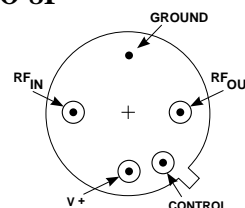

TC-1

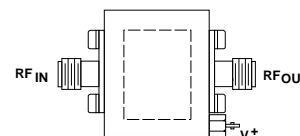

Maximum Ratings

Parameter	Maximum
DC Voltage	+17 Volts
Continuous RF Input Power	+17 dBm
Operating Case Temperature	-55 to +125°C
Storage Temperature	-62 to +150°C
"R" Series Burn-In Temperature (T _b)	+125°C

Thermal Characteristics¹

θ _{JC}	130/130/130°C/W
Active Transistor Power Dissipation	125/125/175 mW
Junction Temperature Above Case Temperature	16/16/24°C
MTBF (MIL-HDBK-217E, A _{UF} @ 90°C)	378,652 Hrs.

Weight: (typical) 2.1 grams

Electrical Specifications

(Measured in 50 Ω system @ +15 VDC nominal unless otherwise noted)

Symbol	Characteristic	Typical $T_C = 25^\circ\text{C}$	Guaranteed Specifications		Unit
			$T_C = 0$ to 50°C	$T_C = -55$ to $+85^\circ\text{C}$	
BW	Frequency Range	10-1000	10-1000	10-1000	MHz
GP	Small Signal Gain (Min.)	22	18	17	dB
—	Gain Flatness, $V_{AGC} = 0$ to +3 Volts (Max.)	± 1.0	± 2.0	± 2.5	dB
—	AGC Range, $V_{AGC} = +5$ Volts	35	—	—	dB
NF	Noise Figure, $V_{AGC} = 0$ (Max.)	11.0	12.0	13.0	dB
P _{1dB}	Power Output @ +1 dB Compression $V_{AGC} = 0$ (Min.)	+8.0	+5.0	+3.0	dBm
—	Input VSWR, $V_{AGC} = 0$ to +5 Volts (Max.)	1.5:1	2.0:1	2.0:1	—
—	Output VSWR, $V_{AGC} = 0$ to +5 Volts (Max.)	1.5:1	2.0:1	2.0:1	—
IP ₃	Two Tone 3rd Order Intercept Point	+20.0	—	—	dBm
IP ₂	Two Tone 2nd Order Intercept Point	+40.0	—	—	dBm
HP ₂	One Tone 2nd Harmonic Intercept Point	+50.0	—	—	dBm
—	Response Time (10 to 90%)	25	—	—	μs
VDC	Bias Voltage	+15	—	—	Volts
I _D	Bias Current	90	—	—	mA
V _{AGC}	AGC Voltage	0 to +5	—	—	Volts
I _{AGC}	AGC Current	0 to 12	—	—	mA

Typical Performance Over Temperature (@ +15 VDC unless otherwise noted)

Key: +25°C ———
+85°C - - - - -
-55°C _____

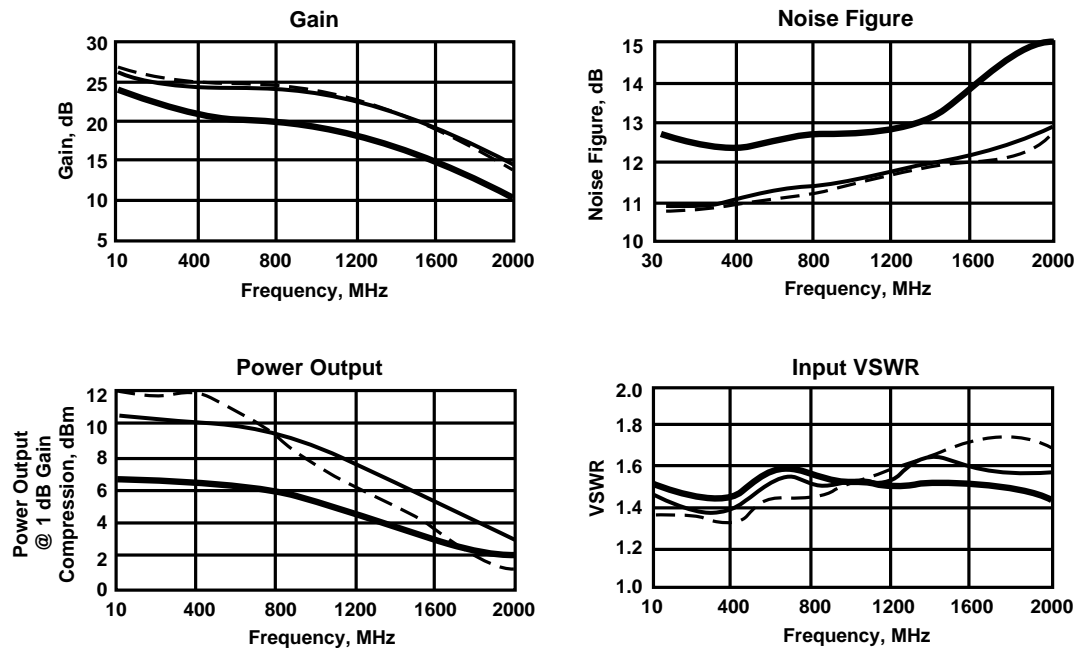

Typical Performance Over Temperature (continued)

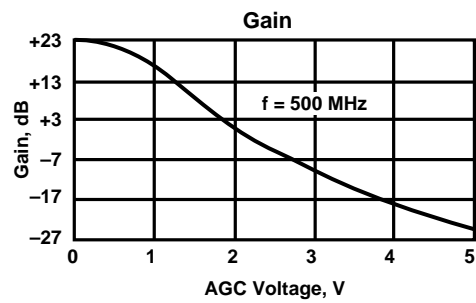
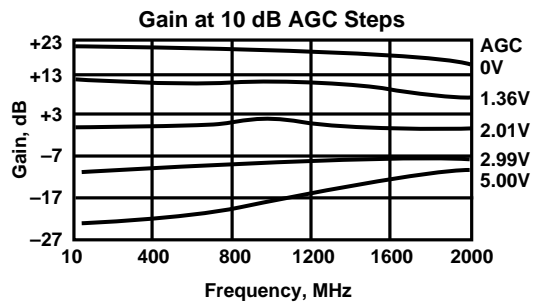
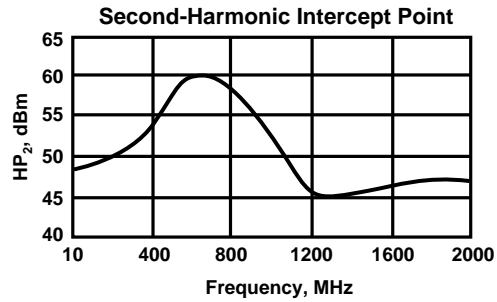
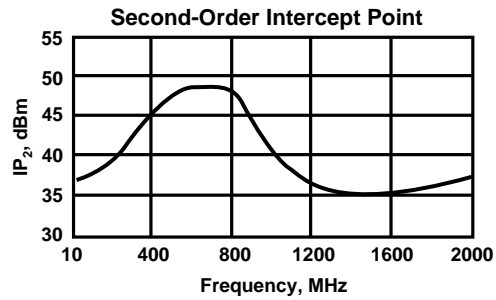
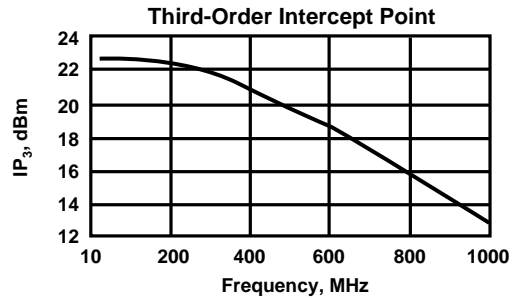
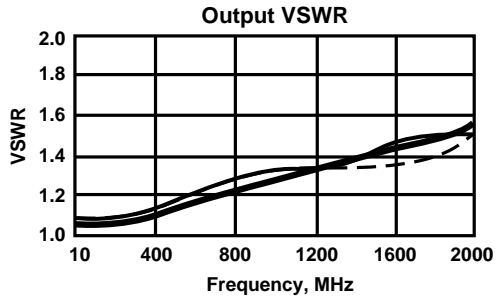

Typical Performance Over Temperature (continued)

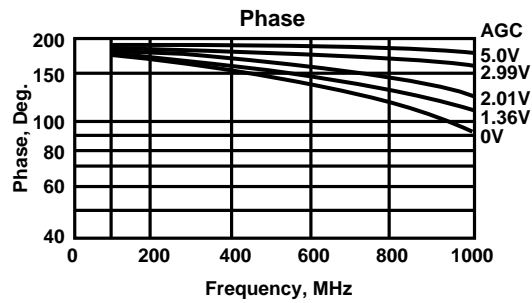
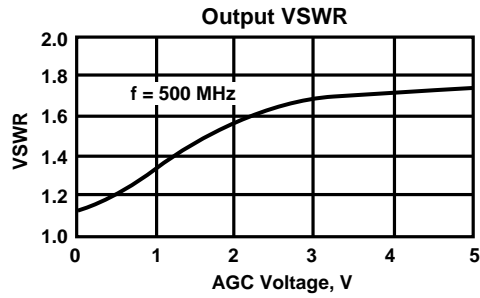
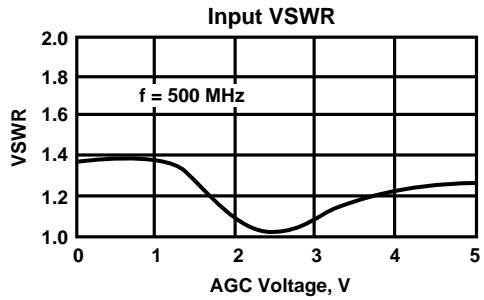
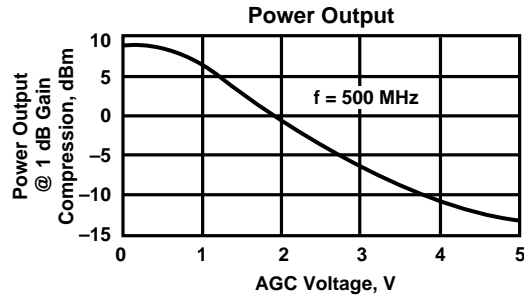
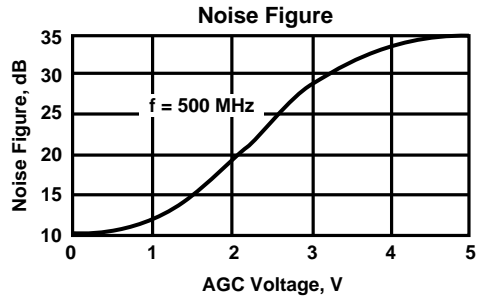

Automatic Network Analyzer Measurements (Typical production unit @ +25°C ambient)

S-Parameters
Bias = 15.00 Volts, Current = 86 mA

FREQUENCY MHz	S ₁₁		S ₂₁		S ₁₂		S ₂₂	
	Mag	Ang	dB	Ang	dB	Ang	Mag	Ang
100.00	.168	3.3	23.100	160.4	-35.047	-177.0	.010	8.2
150.00	.160	-8	22.828	149.5	-37.208	-3.0	.019	-119.0
200.00	.156	-6.1	22.744	140.0	-45.836	66.7	.034	-98.4
250.00	.152	10.8	22.704	129.6	-51.764	-18.7	.032	-95.8
300.00	.151	-14.5	22.600	120.0	-48.073	-38.4	.057	-80.3
350.00	.156	-14.1	22.320	110.4	-54.909	-171.3	.064	-101.6
400.00	.158	-18.4	22.243	101.3	-45.695	40.0	.065	-97.3
450.00	.171	-22.4	22.115	92.3	-50.204	20.9	.075	-96.9
500.00	.185	-23.0	22.112	82.9	-53.132	145.6	.078	-96.6
550.00	.193	-23.5	22.092	73.7	-52.702	68.7	.090	-98.0
600.00	.195	-23.5	22.027	64.5	-52.354	98.2	.097	-99.4
650.00	.195	-23.9	21.960	55.0	-53.418	146.8	.106	-100.5
700.00	.185	-26.6	21.893	45.4	-60.145	162.5	.112	-102.5
750.00	.177	-31.5	21.784	36.3	-55.039	71.8	.121	-104.3
800.00	.174	-36.6	21.720	26.3	-47.281	51.9	.127	-106.2
850.00	.182	-41.2	21.571	15.7	-47.371	49.8	.129	-108.4
900.00	.183	-44.9	21.450	4.9	-56.316	75.2	.132	-113.0
950.00	.189	-49.0	21.291	-5.6	-50.851	112.3	.140	-115.5
1000.00	.194	-49.8	21.113	-16.5	-48.514	75.1	.141	-114.5
1050.00	.195	-47.2	20.897	-26.6	-49.027	80.0	.137	-115.7
1100.00	.192	-44.9	20.699	-36.6	-47.141	74.4	.132	-119.4
1150.00	.193	-43.9	20.454	-46.6	-47.842	81.1	.137	-118.8
1200.00	.197	-45.2	20.181	-56.5	-54.577	110.8	.136	-115.1
1250.00	.204	-47.4	19.852	-65.7	-48.801	78.9	.126	-110.9
1300.00	.218	-50.3	19.508	-75.0	-50.134	59.9	.121	-107.2
1350.00	.238	56.2	19.256	-84.3	-54.313	93.9	.139	-105.3
1400.00	.245	-59.4	19.032	-94.2	-61.674	110.8	.162	-101.8
1450.00	.240	-61.3	18.695	-104.3	-48.073	131.5	.165	-101.0
1500.00	.231	-64.2	18.389	-114.0	-52.090	123.2	.156	-104.0
1550.00	.228	-65.3	17.998	-123.8	-46.604	136.4	.163	-110.3
1600.00	.228	-65.2	17.527	-133.1	-50.210	116.1	.177	-108.5
1650.00	.228	-66.3	17.069	-142.6	-46.314	152.4	.176	-102.7
1700.00	.224	-68.5	16.509	-151.7	-45.587	138.9	.164	-103.3
1750.00	.224	-70.4	15.967	-160.6	-47.299	140.9	.169	-108.1
1800.00	.223	-72.4	15.427	-169.7	-49.243	164.2	.186	-107.9
1850.00	.225	-73.7	14.855	-179.1	-45.932	159.3	.186	-103.2
1900.00	.226	-73.8	14.335	172.5	-48.546	148.4	.173	-103.5
1950.00	.224	-74.1	13.847	164.0	-44.024	146.4	.173	-108.1
2000.00	.224	-74.5	13.294	156.2	-44.810	154.0	.188	-107.2

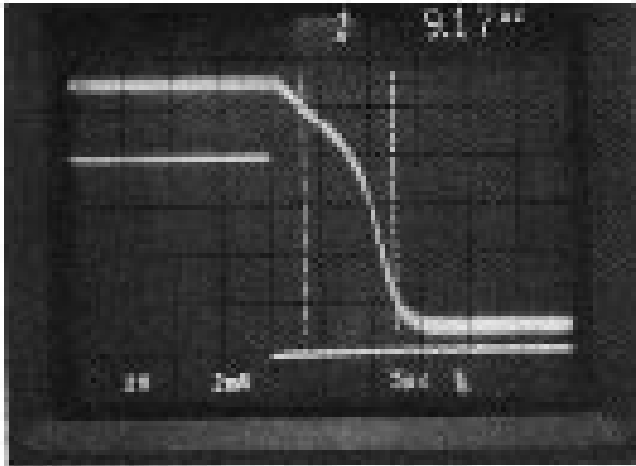

Frequency = 100 MHz
50 μs/Div.
10 dB Gain Change

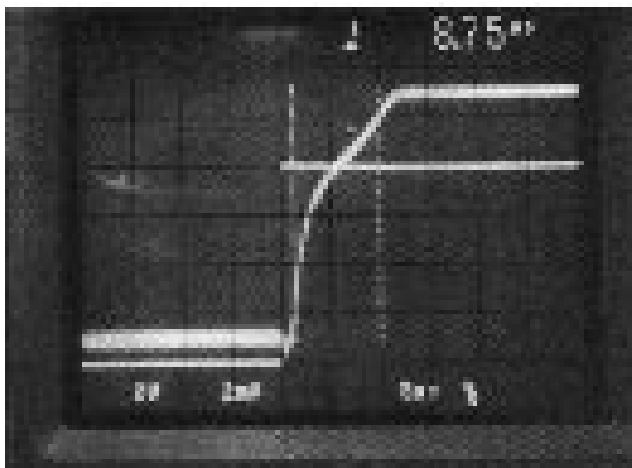

Frequency = 100 MHz
50 μs/Div.
Full AGC Voltage

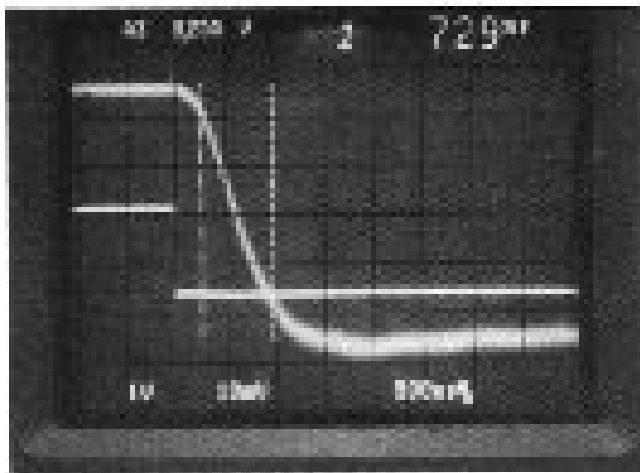

Frequency = 100 MHz
5 μs/Div.
Full AGC Voltage

Product Options

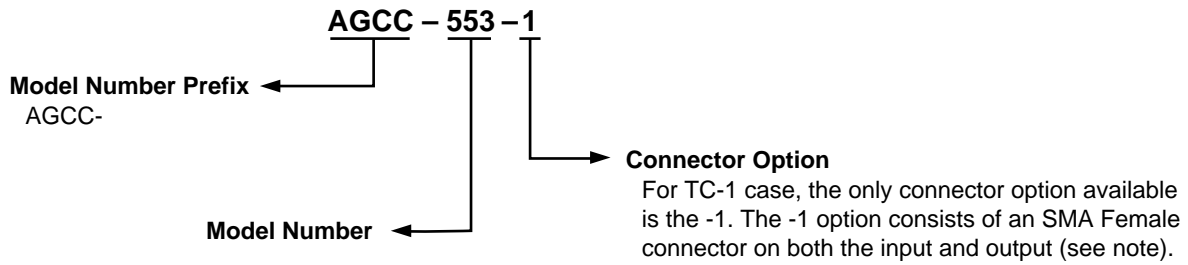
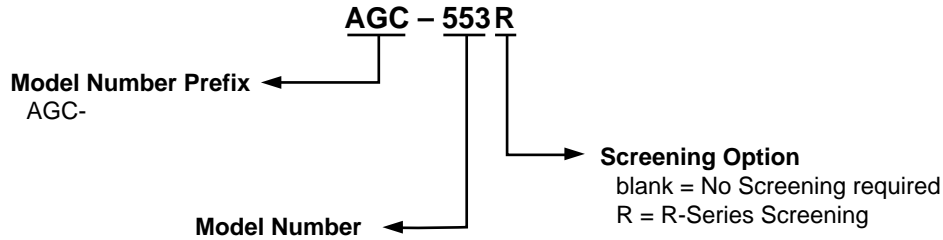

Note: No R-Series screening is available in the TC-1 case as the case is non-hermetic.

Case Drawings TO-8F

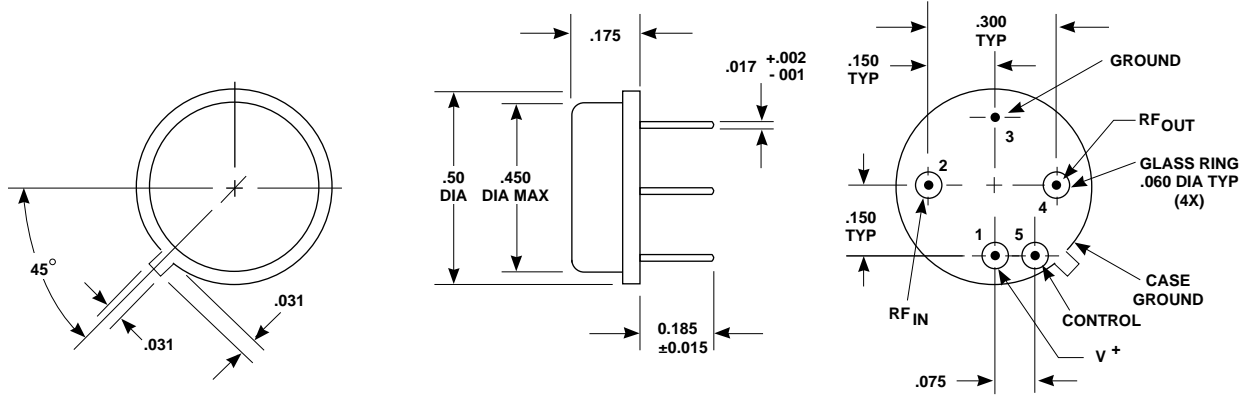

APPROXIMATE WEIGHT 2.1 GRAMS

NOTES (UNLESS OTHERWISE SPECIFIED):
 1. DIMENSIONS ARE SPECIFIED IN INCHES
 2. TOLERANCES: xx ±.02
 xxx ±.010

Case Drawings TC-1

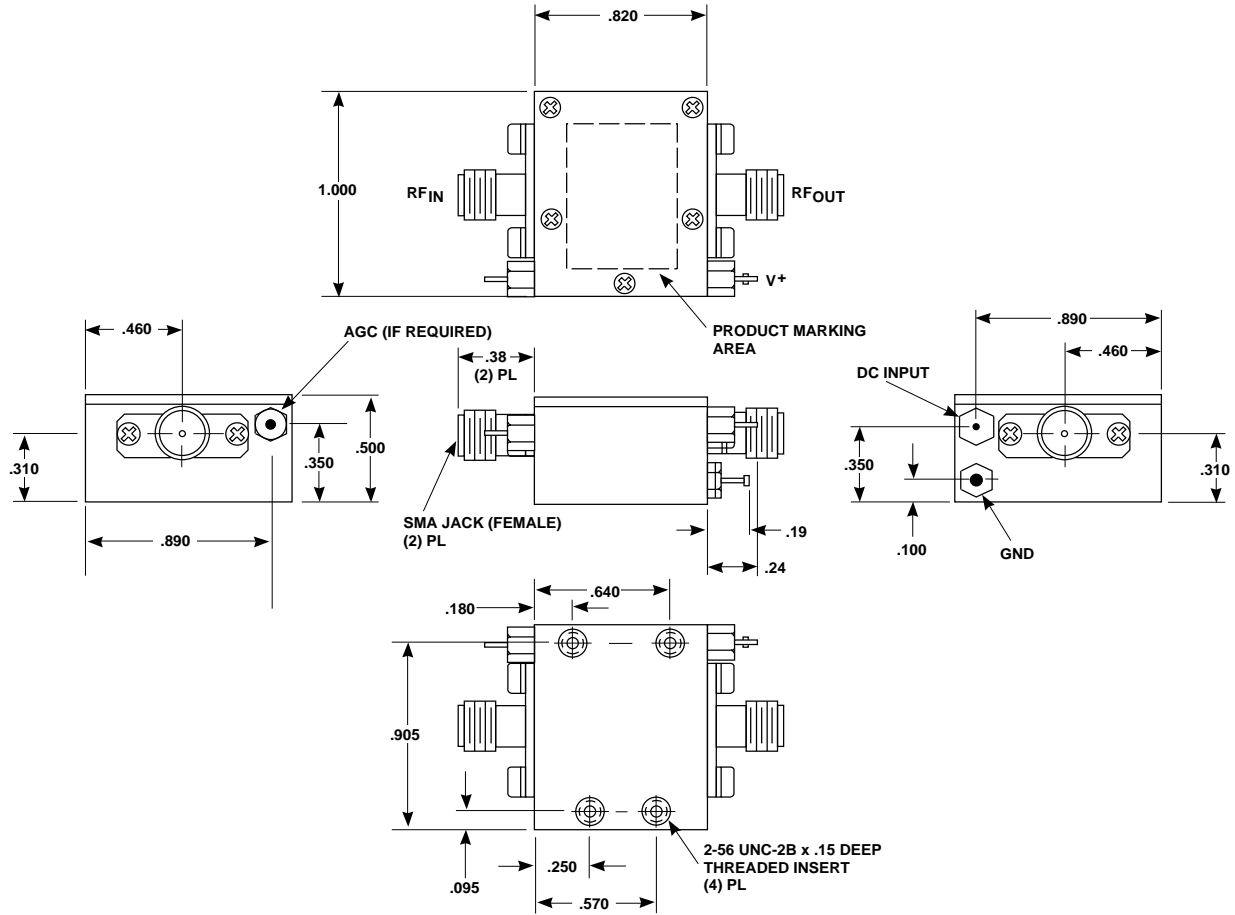

TYPICAL WEIGHT WITH CONNECTORS = 21.5 GRAMS

- NOTES: 1. THE TC-1 CASE IS A NON-HERMETIC CASE.
 2. THE ONLY CONNECTOR OPTION AVAILABLE FOR THE TC-1 CASE IS THE -1, SMA FEMALE CONNECTORS AT BOTH INPUT AND OUTPUT PORTS.

- NOTES (UNLESS OTHERWISE SPECIFIED):
 1. DIMENSIONS ARE SPECIFIED IN INCHES
 2. TOLERANCES: xx ± .02
 xxx ± .010

Contact Teledyne Microwave Solutions:
 650-691-9800
 650-962-6845 fax

Check for updates:
www.teledynemicrowave.com