

# Space Products Selection Guide



Switch Block



Crystal Can

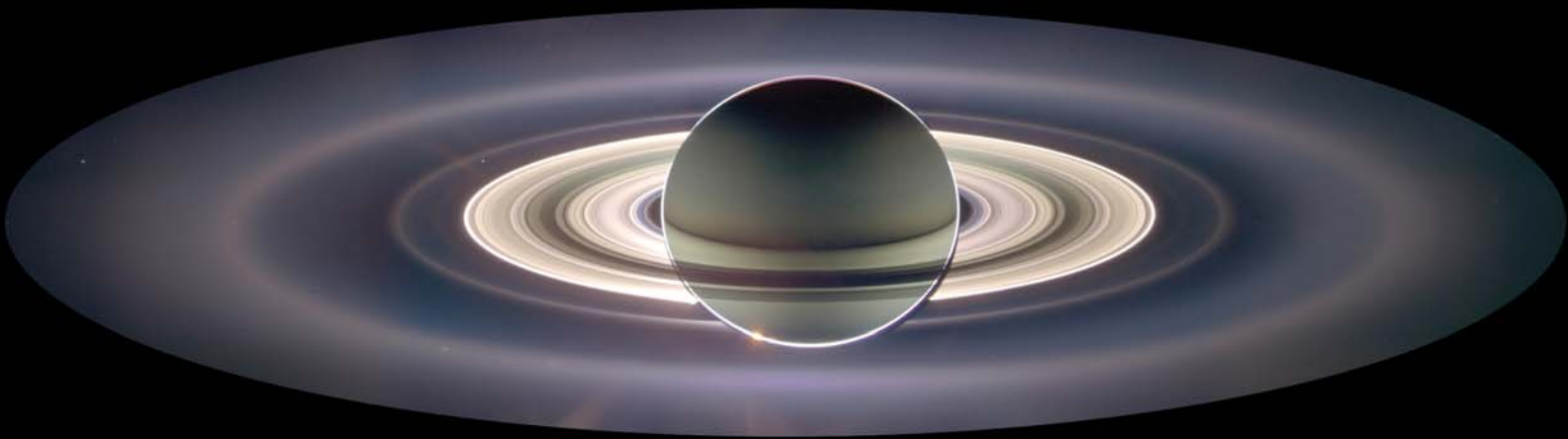

Magnetic-Latching



Failsafe

Transfer



**TELEDYNE  
RELAYS**  
Everywhereyoulook™



**TELEDYNE  
COAX SWITCHES**  
Everywhereyoulook™

Teledyne's electromechanical switch product line consists of a variety of switches designed for commercial, defense, and space applications. Our space-qualified product line consists of TO-5 electromechanical relays, coaxial switches, switch matrices, and switch blocks. These products may be custom-designed and manufactured according to specific performance requirements. Teledyne also provides a complete line of standard, off-the-shelf, high-reliability switches that offers its customers significant cost savings, while satisfying most critical requirements for scientific, meteorological, and communication satellite applications.

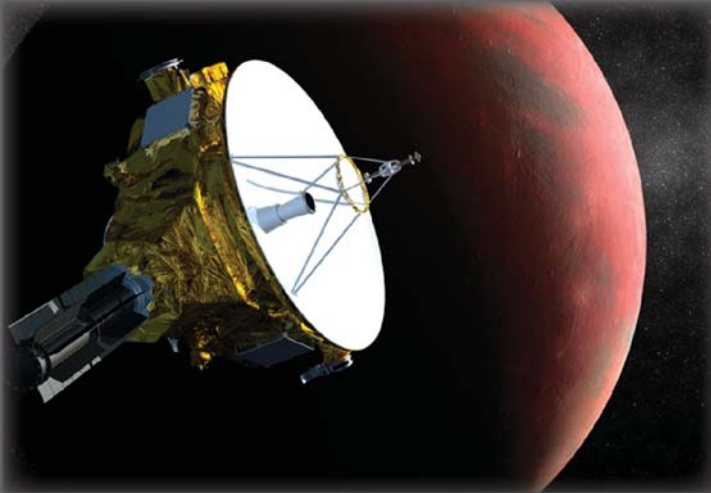

Through numerous challenges over the past 50 years, Teledyne has developed and established a complete line of space qualified switches for high-power applications in L, S, C, KU, and K bands.

Teledyne's fully equipped laboratories are certified for the development and production of space-qualified coaxial switches, and support several large switch production programs.

### Product Assurance

Under an aggressive Total Quality Management (TQM) program, Teledyne has embraced a "continuous improvement" culture. With recognized certifications such as Boeing D1-9000, DSCC MIL-STD-790, and ISO 9001/9002, Teledyne has become a primary supplier of switching solutions with the highest quality and reliability to industry leaders around the world.

### Product Development

Teledyne offers a full range of comprehensive switching solutions. In addition to offering standard switching solutions, our experienced team works closely with our customers to develop tailored products for specific applications. We offer advanced engineering, state-of-the-art manufacturing techniques, and over 50 years of switching experience with a commitment to quality, costs and delivery.

### Technical Service & Customer Support

Teledyne provides easy access to technical service and customer support. Our website makes it easy to find technical information, buy products and e-mail responses within 24 hours. Switching solutions are only a mouse click away at [www.teledynereleys.com](http://www.teledynereleys.com).

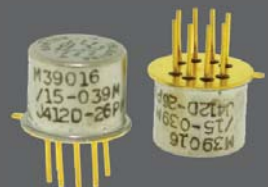

For over fifty years Teledyne Relays has been supplying high reliability switching solutions intended for space flight applications. As the inventor of the ultra-miniature T0-5 electromechanical relay Teledyne Relays has been involved with all facets of the modern space age. From the earliest NASA missions Teledyne Relays has supplied T0-5 relays and RF Coax Switches for use in all type of space craft: manned, unmanned, deep space and robotic exploration.



Teledyne Relays' early involvement in space flight applications has allowed for us to participate in many of the major accomplishments in manned space flight. Our electro-mechanical relays and RF Coax Switches have been, and are currently used in major launch vehicles; **Delta III, Arian IV, Arian V and VEGA** Programs. Additionally our relays are involved in near and deep space exploration, with electro-mechanical relays currently roaming the surface of Mars on both **Rovers** and on their way to the Red Planet on the **Mars Science Lab**. Our electro-mechanical relays are currently orbiting Saturn aboard the **Cassini** Spacecraft and our RF Coaxial Switches are on their way to Pluto aboard the **New Horizons** space craft.

In addition to our participation in un-manned programs we have supplied our Hi-Rel Products for use on manned programs. Our electro-mechanical relays are used in various components of the **International Space Station** and our RF Coax Switches played a major part in the communication system of the **Space Shuttle** fleet.



#### Space Market Segments Served:

- Deep-space Probes
- Manned Programs
- Communications Satellites
- Launch Vehicles
- Earth Observatory / Weather Satellites
- Commercial/Military Satellites

#### Capabilities:

- Logistic Infrastructure
- Chemical Analysis Lab
- Scanning Electro Microscope (SEM)
- In-house Plating Shop
- Environmental Test Lab
- Field Technical Support





	<b>Page</b>
Space Products Introduction	2-3
Space Products Overview	4-5
Space Products Standards	6-7
Space Products Capabilities	8-9
<b>TO-5 &amp; Half-size Crystal Can Space Products</b>	
HR/HRS 412 Series	10-12
HR/HRS 412V Series	13-15
HR/HRS 412K Series	16-18
HR/HRS 422 Series	19-21
HR/HRS 422K Series	22-24
HR 255/257 Series	25-29
EMR Test/Inspection Flow	29
Detailed Summary of Standard Screening	30-32
New Compact, Light Weight, EMR Switch Matrix	29

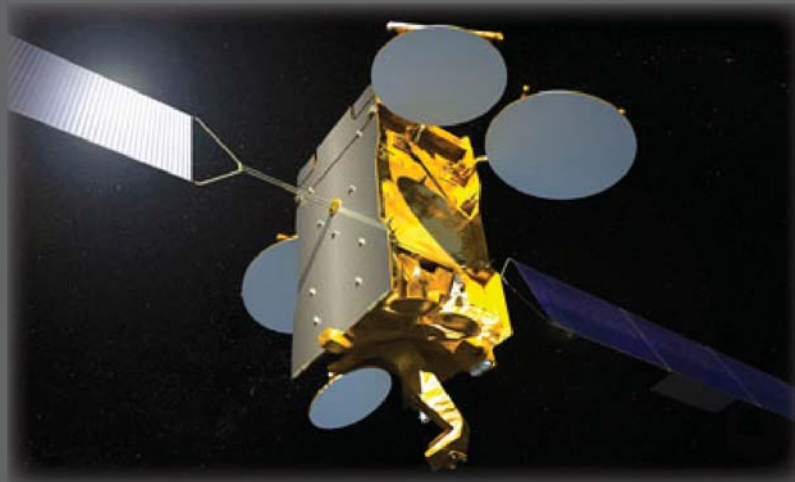

*Arabsat 5C*

# Table of Contents

<b>Coaxial SPDT Switch Space Products</b>		<b>Page</b>
H33S Series		34-35
H32N Series		36-37
<b>Coaxial Transfer Switch Space Products</b>		
H37S Series		38-39
H47N Series		40-41
<b>Coaxial T-Switch Space Products</b>		
ATP COAX Test Flow		48
Detailed Summary of Standard Screening		49
<b>Coaxial Switch Block Assemblies for Space</b>		
CSM Series		50-51
<b>Teledyne Relays HIREL Space Products Program</b>		
Lead Forming Options		52-53
Facilities		54-55
Glossary		56-57
Did You Know...		58-62



*Globalstar 2*



*AsiaSat 7*



*BSAT-3A*



With over forty years of supplying High Reliability (Hi-Rel) electromechanical relays (EMR) and RF Coaxial Switches for space applications Teledyne Relays has developed a High Reliability Program that provides the flexibility of ordering products within a structured and standardized approach. The High Reliability Program for relays is defined in the TR-HIREL-1 Specifications, which consist of a series of documents which define the performance and quality assurance provisions that govern Teledyne Relays' high reliability designs. For RF Coaxial Switch requirements we have developed the General Specification for High Reliability RF Coax Switches, a predefined Source Control Drawing for the procurement of RF switches to be used in space applications. As with the TR-HIREL-1 this document fully defines the requirements for test and inspection, providing detailed information on test methodology and inspection criteria.



*Echostar*

The features and benefits of Teledyne Relays' TR-HIREL-1 Program is that it employs the test methods and inspection criteria in a format compliant to current industry standards for the acquisition of High Reliability Switching Solutions, namely, NASA/GSFC S-311-P-754, NASA EEE-INST-002 and ESA/SCC 3601 and 3602 Specifications. The TR-HIREL-1 contains various tables that list the Specifications under Configuration Control applicable to European Space Agency (ESA) and NASA/Goddard Space Flight Center requirements. The TR-HIREL-1 Specification Program contains test protocols that have been used extensively in High Reliability applications and fully define: configuration, limits, environmental profiles, life cycle expectations, and other key characteristics with the understanding of their impact on performance and associated reliability.



*Hylas 1*



*Hylas 2*

# Product Introduction



Based on specific program requirements, quality assurance testing plans can also be tailored on a menu-based selection. This selection has been developed utilizing Teledyne Relays' extensive experience in offering high reliability products for a wide variety of applications within the space community. Our products have been used on geosynchronous earth orbiting satellites (GEO), low earth orbiting (LEO) satellites, earth observation satellites (EOS), deep space exploration space craft, all of the Mars rovers and manned programs. Additional program heritage is as follows:

## Communication Satellites

Globalstar	TacSat 4
Astra 1N	Luch 5A
AMC-5R	Echostar 14
YahSat	RASCOM-QAF 1, 1R
New Dawn	AEHF (Advanced Extreme High Frequency Satellite)
Arabsat 5C	XM-5
QuetzSat 1	Eutelsat W3B
Intelsat 18	BSAT-3a
AsiaSat 5, 7	SkyTerra 1, 2
Amos 5	HYLAS (Highly Adaptable Satellite).
Hispasat 1E	Koreasat 6 (Olleh 1)
KA-SAT	HOT BIRD 6
ViaSat-1	Anik F3
Skynet 5	Insat 4A, 4B
Astra 1L	Thuraya-2 and 3
Thor 5	WINDS (Kizuna)
DirecTV 10, 11, 12	Star One C1, C2
VINASAT-1	Galaxy 16, 18
Türksat 3A	Superbird 7 (Superbird C2)
AMC-21	Inmarsat-4
Alphasat I-XL	DSCS-3 (Defense Satellite Communications System 3)
SATMEX 5	ETS 6 (Engineering Test Satellite)
Insat 4G	Artemis (Advanced Relay And Technology Mission)
ABS-2	MTSat (Multifunctional Transport Satellite)

## Earth Observation/Remote Sensing Satellites

GRACE  
GRAIL  
GOES N, O, P, Q  
SERVIS (Space Environment Reliability Verification Integrated System)  
COMS (Communication, Ocean and Meteorological Satellite)  
AISat 2A, 2B  
SBSS (Space-Based Space Surveillance System)  
COSMO-SkyMed  
ASTRO (Autonomous Space Transport Robotic Operations satellite)  
GeoEye 1  
ICESAT (Ice, Cloud & Land Elevation Satellite),  
CHIPSat (Cosmic Hot Interstellar Plasma Spectrometer Satellite)  
Radarsat 1  
Oceansat 2  
IRS (Indian Remote Sensing Satellite)  
KOMPSat (Korean Multi-purpose Satellite)  
QuikScat (Quick Scatterometer)  
TOPEX/POSEIDON

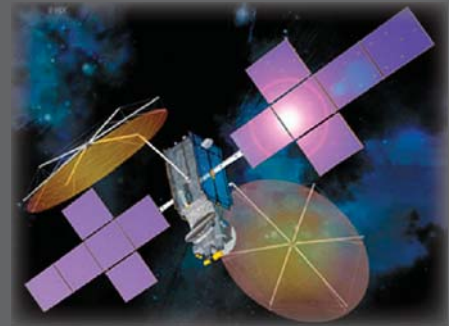

*XM-5 1*

## Deep Space Probes

Juno (New Frontiers 2)  
Mars Science Laboratory (MSL, Curiosity)  
Mars Exploration Rovers  
Pathfinder  
Planet-C or VCO (Venus Climate Orbiter)  
Cassini  
Herschel/Planck  
Hubble Space Telescope  
New Horizons

## Manned Programs

International Space Station Alpha (ISS)  
Space Shuttle (STS)

## Navigation Satellites

Galileo-IOV  
GLONASS  
Global Positioning System (GPS)  
GIOVE B (Galileo In-Orbit Validation Element)



# Product Overview

In addition to meeting the “basic” requirements of the NASA & ESA specifications the TR-HIREL-1 has been configured to provide the user with additional environment test and inspections to satisfy application specific requirements associated with space flight missions. Additional tests contained within the TR-HIREL-1 are Vibration Miss Test (aka Miss Test Under Vibration & Asynchronous Miss Test)

## **Specifications**

NASAS3IIP754

NASA INST-EE

ESASCS360I

ESASCC3602

TR-HIREL -1

## **Certifications**

MILPRF39016

ISO 9001: 2008

NASA SOLDER

BOEING D1-9000

MIL-STD-790

The purpose in developing the TR-HIREL-1 Specification was to provide our customers with a generic specification meeting the basic requirements of the ESA/SCC 3001 & 3602 and the NASA/GSFC S-311-P-754 specifications. The “basic” test protocol is as follows:

## Required Tests

100% Pre-Cap

Small Particle

Sinusoidal Vibration

Random Vibration (when specified)

Resonant Beam Test (High Vibration “V” Relays Only)

P.I.N.D. Test

Internal Moisture

Temperature Condition, High and Low Temperature Miss Test

Electrical Measurements

Leak Test

Radiographic Inspection (X-Ray)

Green Dot Marking

Visual Inspection

The purpose of the TR-HIREL-1 is to provide the user with an established, pre-formatted specification meeting the requirements of the NASA/GSFC S311-P-754, European Space Agency (ESA) Specification SCC/3601 & 3601 and the latest NASA Document EEE-INST-002, Instructions for EEE Parts Selection, Screening, Qualification and Derating. The default requirements of the TR-HIREL meet all three referenced specifications with the following “Final Production Tests” and “Screening and Electrical Measurements”:

100% Pre-cap inspection - Criteria establishing the standard methods for inspection prior to hermetic sealing (Teledyne Relays’ Procedure of Internal Inspection, Document 0-40-115)

Small Particle Inspection/Millipore Clean - in-process inspection to further evaluate relay cleanliness Through an automated small particle inspection process prior to sealing (Teledyne Relays’ Pre-cap Small Particle Inspection, Document 0-40-265)

Sinusoidal Vibration - Standard Vibration test, sinusoidal and random, as specified by MIL-PRF-39016 & MIL-PRF-28776 (MIL-STD-202, Method 204; Test Method: Vibration, High Frequency)

Particle Impact Noise Detection (P.I.N.D.) -This test is designed to detect the presence of loose particles in sealed relays. This test method meets the criteria of MIL-R-39016E, Appendix B\* (Teledyne Relays’ Particle Impact Noise Detection, Document 0-40-824)

Temperature Conditioning & High and Low Temperature Miss Test - Internal Moisture and High and Low Temperature Run-In tests per the requirement of MIL-PRF-39016 & MIL-PRF-28776 (MIL-STD-202, Method 107 Test Method: Thermal Shock)

Room Temperature Miss Test - Relays shall be subjected to a 2,500 cycle run-in test at applicable ambient temperatures. (MIL-PRF-39016)

Electrical Measurements - used to prove that the component part can operate safely at its rated voltage (MIL-PRF-39016 & MIL-STD-202)

**Leak/Seal Test** The purpose of this test method is to determine the effectiveness of the seal of a component part which has an internal cavity which is either evacuated or contains air or gas there shall be no leakage in excess of  $1 \times 10^{-6}$  atm-cm<sup>3</sup>/s of air.

(MIL-STD-202, Method 112 Test Method: Seal)

**Radiographic Inspection (X-ray)** Each relay shall be examined to determine proper internal construction and workmanship. Teledyne Relays' Radiographic Inspection of Relays, Document No. 0-40-193

**External Visual and Mechanical Inspection** Relays shall be examined to verify that the marking, header glass, external design and construction, physical dimensions and workmanship are in accordance with Teledyne Relays' acceptance criteria. Teledyne Relays' Inspection Criteria, External Visual and Mechanical, Document 0-40-913.

The TR-HIREL-1 specification is a guideline to aid in the procurement of electromechanical relays furnished to meet the requirements of all applicable electro-mechanical specifications:

- MIL-PRF-39016
- MIL-PRF-28776
- NASA/GSFC S-311-P-754
- NASA EEE-INST-002
- ESA/SCC 3601
- ESA/SCC 3602

The TR-HIREL-1 provides an efficient cost effective alternative to the requirements for Source Control Drawings (SCD) and the cycle of specification reviews associated with them. The TR-HIREL-1 has the heritage and credibility of worldwide recognition and use in every facet of the space community. Relays screened in accordance with the TR-HIREL-1 are currently in use on communications satellites, deep space probes and launch vehicles. The specification has been embraced on an international level because of its ability to satisfy NASA and ESA requirements with its default requirements. In addition to being used as a stand-alone procurement specification the TR-HIREL-1 has been used as the baseline for customer SCD's.

# Product Capabilities



## Teledyne Relays' TR-HIREL-1 High Reliability Specification

For over Fifty years Teledyne Relays has been supplying High Reliability relays to the aerospace community for use in space flight applications. Drawing on this experience we have developed the TR-HIREL-1 Specification Program. This Program provides our customers with the means to order high reliability switching solutions to established specification which define the performance requirements in addition to the governing quality assurance provisions. The TR-HIREL-1 Program consists of a series of documents which define the performance and quality assurance provisions comparable to those defined in:

NASA/GSFC S-311-P-754  
NASA EE-INST-002  
ESA/SCC 3601  
ESA/SCC 3602

Design control and configuration control activities are conducted as prescribed by recognized industry standards such as ISO 9001, Boeing AS9000 and MIL-STD-709.

The TR-HIREL -1 Specification provides for the customization of test plans to assist the user in verifying the functionality of the product procured before installation into higher level assemblies. Verification can be achieved by any combination of the following:

- Custom qualification plans jointly developed by Teledyne Relays and the customer.
- Review of existing historical data compiled from similar designs.
- Custom selection of test and inspection variants during Production Lot manufacture.
- Menu driven Lot Acceptance Tests based on MIL-PRF-39016 & ESA/SCC requirements.

For more information, or assistance in the application of the TR-HIREL-1 Program, please contact your regional Sales Office:

United States, Canada, & Asia  
12525 Daphne Ave.  
Hawthorne, California 90250-3384  
Phone: 323.777.0077  
Fax: 323.241.1287

EMEA (Europe, The Middle East, and Africa)  
9-13 Napier Road  
Cumbernauld G68 OEF  
Scotland, UK  
Phone: +44 (0) 1236-733-700  
Fax: +44 (0) 1236-780-651



PART NUMBER	DESCRIPTION
HR412	Non-Latching, DPDT, TO-5 Space Grade Relay (HIREL)
HRS412	Non-Latching, DPDT, TO-5 Space Grade Relay (HIREL), Surface Mount J-Leads
<p>Teledyne Relays' HR/HRS412 Series relay is a High Reliability Off-The Shelf relay suitable for demanding space flight applications. When purchased in accordance with Teledyne Relays' standard Hi-Rel Acceptance Test Procedure (ATP) the relays will meet the basic requirements of both the NASA Goddard Space Flight Center's S-311-P-754 Document and the European Space Agency's (ESA) SCC 3601 &amp; 3602 Specifications. The HR/HRS412 Series has become the premier selection for space flight applications requiring low-level switching to dry circuits up to 1 Amp. Teledyne Relays' 50 year history of supplying relays to the spacecraft manufacturing community has supported 95% of all satellite programs worldwide. Relays may be supplied in accordance with the standard requirements of the Hi-Rel ATP or as specified by customer source control drawings. In addition to enhanced test and inspection at the relay level the individual piece parts are inspected to higher standards. Relay leads may be supplied in either gold (Au) or solder dipped finish. A variety of formed lead configurations performed by the factory are available. All Hi-Rel relays are supplied with full data packages in either hard copy or electronic format. Customer Source Inspection (CSI) may be performed during critical manufacturing and test points.</p>	

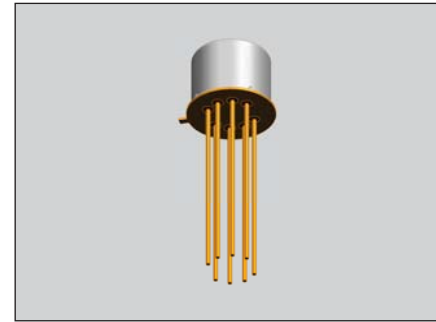

HR/HRS412 HIREL SERIES OVERVIEW
Design Based on QPL-Approved MIL-PRF-39016 Specification
Proven Space Flight Heritage
Meets the general requirements of NASA/GSFC, S311-P-754
Meets the general requirements of ESA/SCC General Specification 3601 & 3602
1x10 <sup>-6</sup> Leak Rate
Standard Acceptance Test Procedure (ATP) Meets both ESA and NASA Requirements
MIL-DTL-45204 Gold Plating
ANSI-J-STD-006 Requirements for Electric Grade Solder Alloys and Fluxed and Non-Fluxed Sold Solders for Electronic Soldering Applications
100% Small Particle/ Inspection (Millipore Cleaning)

STANDARD HIREL SCREENING	
100% Pre-Cap Inspection (Source Inspection Available)	Particle Impact Noise Detection (PIND)
Room Temperature Electrical Measurements	Internal Moisture
Solderability	Thermal Cycle/Miss Test (5,000 cycles total) + 2,500 at Room Temperature
Leak/Seal Test (1x10 <sup>-6</sup> ) CC/sec	Room Temperature Electrical Measurements
External Visual & Mechanical	Radiographic Inspection (X-Ray)
Vibration, Sinusoidal (30 G's)	Percent Defect Allowable, failure rate of lot (less than 10%)

ENVIRONMENTAL AND PHYSICAL CHARACTERISTICS			
Form Factor	2 Form C (DPDT)	Operating Temperature	-65°C to +125°C
Frequency Range	DC-1 GHz	Vibration (Sinusoidal)	30 g's 10 to 2500 Hz
Lead Finish	Gold Plated or Solder Coated	Shock (Specific Pulse)	100 g's, 6ms half sine
Hermetic Seal	1 x 10 <sup>-6</sup> atm-cm <sup>3</sup> /s	Weight	0.09 oz. (2.55) max.

Contact Load and Life Ratings		
LOAD LEVEL	CONTACT LOAD	CONTACT LIFE
Low level/Mechanical	10 – 50 $\mu$ A at 10 – 50 mV d.c. or peak a.c.	100,000 cycles rated life
		1,000,000 cycles unmonitored (Mechanical Life)
Intermediate Current	100mA at 28Vdc	50,000 cycles
High Level, Resistive	1.0A at 28Vdc	100,000 cycles
High Level, Inductive	200mA at 28Vdc, with 0.32H inductance	100,000 cycles
High Level, Lamp	100mA at 28Vdc	100,000 cycles
Overload, Resistive	2.0A at 28Vdc	100 cycles

*Specifications based on relay case being grounded, unless otherwise specified*

Static Contact Resistance or Voltage Drop					
Measurement Condition		Maximum Static Contact Resistance or Voltage Drop			
		Without attached spacer/spreader pad	With M4 spacer pad attached	With M/M3 spreader pad attached	With M2 spreader pad attached
Initial		0.100 $\Omega$	0.110 $\Omega$	0.125 $\Omega$	0.150 $\Omega$
Low Level Life	During test	33 $\Omega$ (1.65mVdc monitoring Level)			
	After 100,000 or 1,000,000 cycle life	0.150 $\Omega$	0.160 $\Omega$	0.175 $\Omega$	0.200 $\Omega$
Intermediate Current	During test	1 $\Omega$ (100mVdc monitoring Level)			
	After 50,000	0.200 $\Omega$	0.210 $\Omega$	0.225 $\Omega$	0.250 $\Omega$
High Level Life	During life	Voltage drop no more than 5% of open circuit voltage (1.4 Vdc monitoring level)			
	After 100,000 cycle life	0.200 $\Omega$	0.210 $\Omega$	0.225 $\Omega$	0.250 $\Omega$
Overload	During test	Not Monitored			
	After 100,000 cycle life	0.200 $\Omega$	0.210 $\Omega$	0.225 $\Omega$	0.250 $\Omega$

General Electrical Specifications	
Insulation Resistance	10,000 M $\Omega$ minimum at 500Vdc
	1,000M $\Omega$ minimum at 500Vdc between coil and case at +125°C
	1,000M $\Omega$ minimum at 500Vdc after 100 cycle overload
	100,000 cycle high life, or 50,000 intermediate current tests
Dielectric Strength	500Vrms $\pm$ 5% at 50 or 60Hz
	375Vrms at 50 or 60Hz after 100 cycle overload, 100,000 cycle high level life, or 50,000 intermediate current tests
Operate Time	2.0 ms maximum with rated coil voltage
Release Time	1.5 ms maximum from rated coil voltage
Release Time (with diode)	4.0 ms maximum from rated coil voltage
Negative Coil Transient (Vdc)	1.0 max.
Block Integrity max. leakage current	1 $\mu$ A at 50Vdc
Breakdown Voltage	100Vdc min. at 10 $\mu$ A

Coil Data and Operating Characteristics of Basic Relays and Relays with optional Diode for Coil Transient Suppression								
Coil Voltage (Vdc)		Room Ambient Temperature (+25°C)				Over Temperature Range		
Rated	Max	Coil Resistance (Ω) ±10%	Pick-Up Voltage (Vdc) max.	Hold Voltage (Vdc) max.	Drop-Out Voltage (Vdc) max.	Pick-Up Voltage (Vdc) max.	Hold Voltage (Vdc) max.	Drop-Out Voltage (Vdc) max.
5.0	5.8	50	2.7	1.4	0.22	3.5	2.3	0.14
6.0	8.0	98	3.5	2.0	0.28	4.5	3.2	0.18
9.0	12.0	220	5.3	3.0	0.54	6.8	4.9	0.35
12.0	16.0	390	7.0	4.0	0.63	9.0	6.5	0.41
18.0	24.0	880	10.5	6.0	0.91	13.5	10.0	0.59
26.5	32.0	1560	14.2	8.0	1.37	18.0	13.0	0.89

Coil Data and Operating Characteristics of Relays with Optional Diodes for Coil Transient Suppression and Polarity Reversal Protection										
Coil Voltage (Vdc)		Room Ambient Temperature (+25°C)					Over Temperature Range			
Rated	Max	Coil Resistance (Ω) ±10%	Coil Current (mA)		Pick-Up Voltage (Vdc) max.	Hold Voltage (Vdc) max.	Drop-Out Voltage (Vdc) max.	Pick-Up Voltage (Vdc) max.	Hold Voltage (Vdc) max.	Drop-Out Voltage (Vdc) max.
			Max.	Min.						
5.0	5.8	39	128.2	93.2	3.2	2.3	0.60	4.0	2.8	0.60
6.0	8.0	78	78.3	58.3	4.0	2.8	0.70	5.0	3.4	0.70
9.0	12.0	220	42.9	33.0	6.3	4.2	0.90	7.8	5.3	0.80
12.0	16.0	390	32.8	25.6	8.0	5.2	1.10	10.0	6.5	0.90
18.0	24.0	880	22.1	17.5	11.5	7.3	1.40	14.5	10.0	1.10
26.5	32.0	1560	18.5	14.8	15.2	9.5	1.80	19.0	13.0	1.40

**Series HR412V/ HR412V**  
**DC up to 1 GHz, High Vibration**  
**Non-Latching Space Grade DPDT Relay**



PART NUMBER	DESCRIPTION
HR412V	Non-Latching, DPDT, TO-5 Space Grade Relay (HIREL), High Vibration
HRS412V	Non-Latching, DPDT, TO-5 Space Grade Relay (HIREL), High Vibration, Surface Mount J-Leads

Teledyne Relays' HR/HRS412V Series relay is a High Reliability Off-The Shelf (COTS) relay suitable for demanding space flight applications. When purchased in accordance with Teledyne Relays' standard Hi-Rel Acceptance Test Procedure (ATP) the relays will meet the basic requirements of both the NASA Goddard Space Flight Center's S-311-P-754 Document and the European Space Agency's (ESA) SCC 3601 & 3602 Specifications. The HR/HRS412V Series has become the premier selection for space flight applications requiring low-level switching to dry circuits up to 1 Amp. Teledyne Relays' 50 year history of supplying relays to the spacecraft manufacturing community has supported 95% of all satellite programs worldwide. Relays may be supplied in accordance with the standard requirements of the Hi-Rel ATP or as specified by customer source control drawings. In addition to enhanced test and inspection at the relay level the individual piece parts are inspected to higher standards. Relay leads may be supplied in either gold (Au) or solder dipped finish. A variety of formed lead configurations performed by the factory are available. All Hi-Rel relays are supplied with full data packages in either hard copy or electronic format. Customer Source Inspection (CSI) may be performed during critical manufacturing and test points.

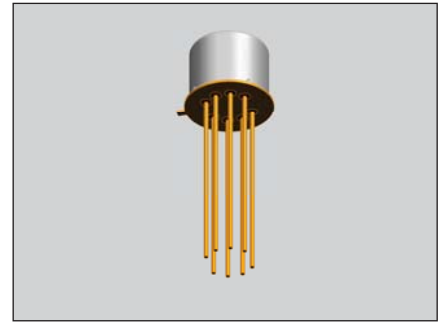

HR/HRS412V HIREL SERIES OVERVIEW
Design Based on QPL-Approved MIL-PRF-39016 Specification
Proven Space Flight Heritage
Meets the general requirements of NASA/GSFC, S311-P-754
Meets the general requirements of ESA/SCC General Specification 3601 & 3602
1x10 <sup>-6</sup> Leak Rate
Standard Acceptance Test Procedure (ATP) Meets both ESA and NASA Requirements
MIL-DTL-45204 Gold Plating
ANSI-J-STD-006 Requirements for Electric Grade Solder Alloys and Fluxed and Non-Fluxed Sold Solders for Electronic Soldering Applications
100% Small Particle/ Inspection (Millipore Cleaning)

STANDARD HIREL SCREENING	
100% Pre-Cap Inspection (Source Inspection Available)	Particle Impact Noise Detection (PIND)
Room Temperature Electrical Measurements	Internal Moisture
Solderability	Thermal Cycle/Miss Test (5,000 cycles total) + 2,500 at Room Temperature
Leak/Seal Test (1x10 <sup>-6</sup> ) cc/sec	Room Temperature Electrical Measurements
External Visual & Mechanical	Radiographic Inspection (X-Ray)
Vibration, Sinusoidal (30 G's)	Percent Defect Allowable, failure rate of lot (less than 10%)

ENVIRONMENTAL AND PHYSICAL CHARACTERISTICS			
Form Factor	2 Form C (DPDT)	Operating Temperature	-65°C to +125°C
Frequency Range	DC-3 GHz	Vibration (Sinusoidal)	30 g's 10 to 2500 Hz
Lead Finish	Gold Plated or Solder Coated	Shock (Specific Pulse)	100 g's, 6ms half sine
Hermetic Seal	1 x 10 <sup>-6</sup> atm-cm <sup>3</sup> /s	Weight	0.09 oz. (2.55) max.

Contact Load and Life Ratings		
LOAD LEVEL	CONTACT LOAD	CONTACT LIFE
Low level/Mechanical	10-50 $\mu$ A at 10-50 mVdc or Peak AC	100,000 cycles rated life
		1,000,000 cycles unmonitored (Mechanical Life)
Intermediate Current	100mA at 28Vdc	50,000 cycles
High Level, Resistive	1.0A at 28Vdc	100,000 cycles
High Level, Inductive	200mA at 28Vdc, with 0.32H inductance	100,000 cycles
High Level, Lamp	100mA at 28Vdc	100,000 cycles
Overload, Resistive	2.0A at 28Vdc	100 cycles

*Specifications based on relay case being grounded, unless otherwise specified*

Static Contact Resistance or Voltage Drop					
Measurement Condition		Maximum Static Contact Resistance or Voltage Drop			
		Without attached spacer/spreader pad	With M4 spacer pad attached	With M/M3 spreader pad attached	With M2 spreader pad attached
Initial		0.100 $\Omega$	0.110 $\Omega$	0.125 $\Omega$	0.150 $\Omega$
Low Level Life	During test	33 $\Omega$ (1.65mVdc monitoring Level)			
	After 100,000 or 1,000,000 cycle life	0.150 $\Omega$	0.160 $\Omega$	0.175 $\Omega$	0.200 $\Omega$
Intermediate Current	During test	1 $\Omega$ (100mVdc monitoring Level)			
	After 50,000	0.200 $\Omega$	0.210 $\Omega$	0.225 $\Omega$	0.250 $\Omega$
High Level Life	During life	Voltage drop no more than 5% of open circuit voltage (1.4 Vdc monitoring level)			
	After 100,000 cycle life	0.200 $\Omega$	0.210 $\Omega$	0.225 $\Omega$	0.250 $\Omega$
Overload	During test	Not Monitored			
	After 100 cycle life	0.200 $\Omega$	0.210 $\Omega$	0.225 $\Omega$	0.250 $\Omega$

General Electrical Specifications	
Insulation Resistance	10,000 M $\Omega$ minimum at 500Vdc
	1,000M $\Omega$ minimum at 500Vdc between coil and case at +125°C
	1,000M $\Omega$ minimum at 500Vdc after 100 cycle overload
	100,000 cycle high life, or 50,000 intermediate current tests
Dielectric Strength	500Vrms $\pm$ 5% at 50 or 60Hz
	375Vrms at 50 or 60Hz after 100 cycle overload, 100,000 cycle high level life, or 50,000 intermediate current tests
Operate Time	3.0 ms maximum with rated coil voltage
Release Time	2.0 ms maximum from rated coil voltage
Release Time (With Diode)	4.0 ms maximum from rated coil voltage
Negative Coil Transient (Vdc)	1.0 max.
Block Integrity max. leakage current	1 $\mu$ A at 50Vdc
Breakdown Voltage	100Vdc min. at 10 $\mu$ A



**Series HR412V/ HR412V**  
 DC up to 1 GHz, High Vibration  
 Non-Latching Space Grade DPDT Relay



Coil Data and Operating Characteristics of Basic Relays								
Coil Voltage (Vdc)		Room Ambient Temperature (+25°C)				Over Temperature Range		
Rated	Max	Coil Resistance (Ω) ±10%	Pick-Up Voltage (Vdc) max.	Hold Voltage (Vdc) max.	Drop-Out Voltage (Vdc) max.	Pick-Up Voltage (Vdc) max.	Hold Voltage (Vdc) max.	Drop-Out Voltage (Vdc) max.
5.0	5.8	50	3.38	1.25	0.27	4.6	2.3	0.14
6.0	8.0	70	4.05	1.5	0.32	5.5	3.2	0.18
9.0	12.0	155	6.1	2.3	0.48	8.2	4.9	0.35
12.0	16.0	235	8.1	3.0	0.65	11.0	6.5	0.41
18.0	24.0	610	12.2	4.5	0.97	16.5	10.0	0.59
26.5	32.0	1130	16.3	6.0	1.3	22.0	13.0	0.89

Coil Data and Operating Characteristics of Relays with Optional Diodes for Coil Transient Suppression								
Coil Voltage (Vdc)		Room Ambient Temperature (+25°C)				Over Temperature Range		
Rated	Max	Coil Resistance (Ω) ±10%	Pick-Up Voltage (Vdc) max.	Hold Voltage (Vdc) max.	Drop-Out Voltage (Vdc) max.	Pick-Up Voltage (Vdc) max.	Hold Voltage (Vdc) max.	Drop-Out Voltage (Vdc) max.
5.0	5.8	33	3.38	1.25	0.27	4.6	2.3	0.14
6.0	8.0	44	4.05	1.5	0.32	5.5	3.2	0.18
9.0	12.0	125	6.1	2.3	0.48	8.2	4.9	0.35
12.0	16.0	215	8.1	3.0	0.65	11.0	6.5	0.41
18.0	24.0	470	12.2	4.5	0.97	16.5	10.0	0.59
26.5	32.0	1050	16.3	6.0	1.3	22.0	13.0	0.89

Coil Data and Operating Characteristics of Relays with Optional Diodes for Coil Transient Suppression and Polarity Reversal Protection										
Coil Voltage (Vdc)		Room Ambient Temperature (+25°C)					Over Temperature Range			
Rated	Max	Coil Resistance (Ω) ±10%	Coil Current (mA)		Pick-Up Voltage (Vdc) max.	Hold Voltage (Vdc) max.	Drop-Out Voltage (Vdc) max.	Pick-Up Voltage (Vdc) max.	Hold Voltage (Vdc) max.	Drop-Out Voltage (Vdc) max.
			Max.	Min.						
5.0	5.8	33	126.4	92.8	3.38	1.9	0.27	4.6	2.3	0.14
6.0	8.0	44	122.6	90.4	4.05	2.2	0.32	5.5	3.2	0.18
9.0	12.0	125	73.4	54.3	6.1	3.3	0.48	8.2	4.9	0.35
12.0	16.0	215	59.4	37.8	8.1	3.8	0.65	11.0	6.5	0.41
18.0	24.0	470	42.0	31.3	12.2	5.3	0.97	16.5	10.0	0.59
26.5	32.0	1050	28.3	21.3	16.3	6.8	1.3	22.0	13.0	0.89

PART NUMBER	DESCRIPTION
HR412K	Non-Latching, DPDT, TO-5 Space Grade Relay (HIREL), High Shock
HRS412K	Non-Latching, DPDT, TO-5 Space Grade Relay (HIREL), High Shock, Surface Mount J-Leads

Teledyne Relays' HR/HRS412K Series relay is a High Reliability Off-The Shelf (COTS) relay suitable for demanding space flight applications. When purchased in accordance with Teledyne Relays' standard Hi-Rel Acceptance Test Procedure (ATP) the relays will meet the basic requirements of both the NASA Goddard Space Flight Center's S-311-P-754 Document and the European Space Agency's (ESA) SCC 3601 & 3602 Specifications. The HR/HRS412K Series has become the premier selection for space flight applications requiring low-level switching to dry circuits up to 1 Amp. Teledyne Relays' 50 year history of supplying relays to the spacecraft manufacturing community has supported 95% of all satellite programs worldwide. Relays may be supplied in accordance with the standard requirements of the Hi-Rel ATP or as specified by customer source control drawings. In addition to enhanced test and inspection at the relay level the individual piece parts are inspected to higher standards. Relay leads may be supplied in either gold (Au) or solder dipped finish. A variety of formed lead configurations performed by the factory are available. All Hi-Rel relays are supplied with full data packages in either hard copy or electronic format. Customer Source Inspection (CSI) may be performed during critical manufacturing and test points.

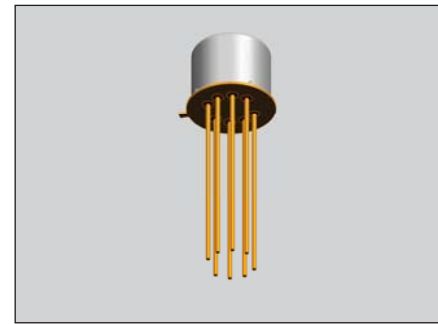

HR/HRS412K HIREL SERIES OVERVIEW
Design Based on QPL-Approved MIL-PRF-39016 Specification
Proven Space Flight Heritage
Meets the general requirements of NASA/GSFC, S311-P-754
Meets the general requirements of ESA/SCC General Specification 3601 & 3602
1x10 <sup>-6</sup> Leak Rate
Standard Acceptance Test Procedure (ATP) Meets both ESA and NASA Requirements
MIL-DTL-45204 Gold Plating
ANSI-J-STD-006 Requirements for Electric Grade Solder Alloys and Fluxed and Non-Fluxed Sold Solders for Electronic Soldering Applications
100% Small Particle/ Inspection (Millipore Cleaning)

STANDARD HIREL SCREENING	
100% Pre-Cap Inspection (Source Inspection Available)	Particle Impact Noise Detection (PIND)
Room Temperature Electrical Measurements	Internal Moisture
Solderability	Thermal Cycle/Miss Test (5,000 cycles total) + 2,500 at Room Temperature
Leak/Seal Test (1x10 <sup>-6</sup> ) cc/sec	Room Temperature Electrical Measurements
External Visual & Mechanical	Radiographic Inspection (X-Ray)
Vibration, Sinusoidal (30 G's)	Percent Defect Allowable, failure rate of lot (less than 10%)

ENVIRONMENTAL AND PHYSICAL CHARACTERISTICS			
Form Factor	2 Form C (DPDT)	Operating Temperature	-65°C to +125°C
Frequency Range	DC-3 GHz	Vibration (Sinusoidal)	30 g's 10 to 3000 Hz
Lead Finish	Gold Plated or Solder Coated	Shock (Specific Pulse)	75 g's, 6ms half sine
Hermetic Seal	1 x 10 <sup>-6</sup> atm-cm <sup>3</sup> /s	Weight	0.09 oz. (2.55) max.

Contact Load and Life Ratings		
LOAD LEVEL	CONTACT LOAD	CONTACT LIFE
Low level/Mechanical	10-50µA at 10-50 mVdc or Peak AC	100,000 cycles rated life
		1,000,000 cycles unmonitored (Mechanical Life)
Intermediate Current	100mA at 28Vdc	50,000 cycles
High Level, Resistive	1.0A at 28Vdc	100,000 cycles
High Level, Inductive	200mA at 28Vdc, with 0.32H inductance	100,000 cycles
High Level, Lamp	100mA at 28Vdc	100,000 cycles
Overload, Resistive	2.0A at 28Vdc	100 cycles

*Specifications based on relay case being grounded, unless otherwise specified*

Static Contact Resistance or Voltage Drop					
Measurement Condition		Maximum Static Contact Resistance or Voltage Drop			
		Without attached spacer/spreader pad	With M4 spacer pad attached	With M/M3 spreader pad attached	With M2 spreader pad attached
Initial		0.100Ω	0.110Ω	0.125Ω	0.150Ω
Low Level Life	During test	33Ω (1.65mVdc monitoring Level)			
	After 100,000 or 1,000,000 cycle life	0.150Ω	0.160Ω	0.175Ω	0.200Ω
Intermediate Current	During test	1Ω (100mVdc monitoring Level)			
	After 50,000	0.200Ω	0.210Ω	0.225Ω	0.250Ω
High Level Life	During life	Voltage drop no more than 5% of open circuit voltage (1.4 Vdc monitoring level)			
	After 100,000 cycle life	0.200Ω	0.210Ω	0.225Ω	0.250Ω
Overload	During test	Not Monitored			
	After 100 cycle life	0.200Ω	0.210Ω	0.225Ω	0.250Ω

General Electrical Specifications	
Insulation Resistance	10,000 MΩ minimum at 500Vdc
	1,000MΩ minimum at 500Vdc between coil and case at +125°C
	1,000MΩ minimum at 500Vdc after 100 cycle overload
	100,000 cycle high life, or 50,000 intermediate current tests
Dielectric Strength	500Vrms ±5% at 50 or 60Hz
	375Vrms at 50 or 60Hz after 100 cycle overload, 100,000 cycle high level life, or 50,000 intermediate current tests
Operate Time	3.0 ms maximum with rated coil voltage
Release Time	2.0 ms maximum from rated coil voltage
Release Time (With Diode)	4.0 ms maximum from rated coil voltage
Negative Coil Transient (Vdc)	1.0 max.
Block Integrity max. leakage current	1µA at 50Vdc
Breakdown Voltage	100Vdc min. at 10µA

Coil Data and Operating Characteristics of Basic Relays								
Coil Voltage (Vdc)		Room Ambient Temperature (+25°C)				Over Temperature Range		
Rated	Max	Coil Resistance (Ω) ±10%	Pick-Up Voltage (Vdc) max.	Hold Voltage (Vdc) max.	Drop-Out Voltage (Vdc) max.	Pick-Up Voltage (Vdc) max.	Hold Voltage (Vdc) max.	Drop-Out Voltage (Vdc) max.
5.0	5.8	50	3.38	1.25	0.27	4.6	2.3	0.14
6.0	8.0	70	4.05	1.5	0.32	5.5	3.2	0.18
9.0	12.0	155	6.1	2.3	0.48	8.2	4.9	0.35
12.0	16.0	235	8.1	3.0	0.65	11.0	6.5	0.41
18.0	24.0	610	12.2	4.5	0.97	16.5	10.0	0.59
26.5	32.0	1130	16.3	6.0	1.3	22.0	13.0	0.89

Coil Data and Operating Characteristics of Relays with Optional Diodes for Coil Transient Suppression								
Coil Voltage (Vdc)		Room Ambient Temperature (+25°C)				Over Temperature Range		
Rated	Max	Coil Resistance (Ω) ±10%	Pick-Up Voltage (Vdc) max.	Hold Voltage (Vdc) max.	Drop-Out Voltage (Vdc) max.	Pick-Up Voltage (Vdc) max.	Hold Voltage (Vdc) max.	Drop-Out Voltage (Vdc) max.
5.0	5.8	33	3.38	1.25	0.27	4.6	2.3	0.14
6.0	8.0	44	4.05	1.5	0.32	5.5	3.2	0.18
9.0	12.0	125	6.1	2.3	0.48	8.2	4.9	0.35
12.0	16.0	215	8.1	3.0	0.65	11.0	6.5	0.41
18.0	24.0	470	12.2	4.5	0.97	16.5	10.0	0.59
26.5	32.0	1050	16.3	6.0	1.3	22.0	13.0	0.89

Coil Data and Operating Characteristics of Relays with Optional Diodes for Coil Transient Suppression and Polarity Reversal Protection										
Coil Voltage (Vdc)		Room Ambient Temperature (+25°C)					Over Temperature Range			
Rated	Max	Coil Resistance (Ω) ±10%	Coil Current (mA)		Pick-Up Voltage (Vdc) max.	Hold Voltage (Vdc) max.	Drop-Out Voltage (Vdc) max.	Pick-Up Voltage (Vdc) max.	Hold Voltage (Vdc) max.	Drop-Out Voltage (Vdc) max.
			Max.	Min.						
5.0	5.8	33	126.4	92.8	3.38	1.9	0.27	4.6	2.3	0.14
6.0	8.0	44	122.6	90.4	4.05	2.2	0.32	5.5	3.2	0.18
9.0	12.0	125	73.4	54.3	6.1	3.3	0.48	8.2	4.9	0.35
12.0	16.0	215	59.4	37.8	8.1	3.8	0.65	11.0	6.5	0.41
18.0	24.0	470	42.0	31.3	12.2	5.3	0.97	16.5	10.0	0.59
26.5	32.0	1050	28.3	21.3	16.3	6.8	1.3	22.0	13.0	0.89

**Series HR422/ HRS422**  
**DC up to 1 GHz**  
**Magnetic Latching Space Grade DPDT Relay**



PART NUMBER	DESCRIPTION
HR422	Magnetic-Latching, DPDT, TO-5 Space Grade Relay (HIREL)
HRS422	Magnetic-Latching, DPDT, TO-5 Space Grade Relay (HIREL), Surface Mount J-Leads
<p>Teledyne Relays' HR/HRS422 Series relay is a High Reliability Off-The Shelf (COTS) relay suitable for demanding space flight applications. When purchased in accordance with Teledyne Relays' standard Hi-Rel Acceptance Test Procedure (ATP) the relays will meet the basic requirements of both the NASA Goddard Space Flight Center's S-311-P-754 Document and the European Space Agency's (ESA) SCC 3601 &amp; 3602 Specifications. The HR/HRS422 Series has become the premier selection for space flight applications requiring low-level switching to dry circuits up to 1 Amp. Teledyne Relays' 50 year history of supplying relays to the spacecraft manufacturing community has supported 95% of all satellite programs worldwide. Relays may be supplied in accordance with the standard requirements of the Hi-Rel ATP or as specified by customer source control drawings. In addition to enhanced test and inspection at the relay level the individual piece parts are inspected to higher standards. Relay leads may be supplied in either gold (Au) or solder dipped finish. A variety of formed lead configurations performed by the factory are available. All Hi-Rel relays are supplied with full data packages in either hard copy or electronic format. Customer Source Inspection (CSI) may be performed during critical manufacturing and test points.</p>	

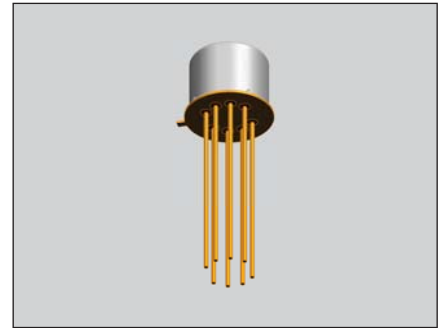

HR/HRS422 HIREL SERIES OVERVIEW
Design Based on QPL-Approved MIL-PRF-39016 Specification
Proven Space Flight Heritage
Meets the general requirements of NASA/GSFC, S311-P-754
Meets the general requirements of ESA/SCC General Specification 3601 & 3602
1x10 <sup>-6</sup> Leak Rate
Standard Acceptance Test Procedure (ATP) Meets both ESA and NASA Requirements
MIL-DTL-45204 Gold Plating
ANSI-J-STD-006 Requirements for Electric Grade Solder Alloys and Fluxed and Non-Fluxed Sold Solders for Electronic Soldering Applications
100% Small Particle/ Inspection (Millipore Cleaning)

STANDARD HIREL SCREENING	
100% Pre-Cap Inspection (Source Inspection Available)	Particle Impact Noise Detection (PIND)
Room Temperature Electrical Measurements	Internal Moisture
Solderability	Thermal Cycle/Miss Test (5,000 cycles total) + 2,500 at Room Temperature
Leak/Seal Test (1x10 <sup>-6</sup> ) cc/sec	Room Temperature Electrical Measurements
External Visual & Mechanical	Radiographic Inspection (X-Ray)
Vibration, Sinusoidal (30 G's)	Percent Defect Allowable, failure rate of lot (less than 10%)

ENVIRONMENTAL AND PHYSICAL CHARACTERISTICS			
Form Factor	2 Form C (DPDT)	Operating Temperature	-65°C to +125°C
Frequency Range	DC-3 GHz	Vibration (Sinusoidal)	30 g's 10 to 2500 Hz
Lead Finish	Gold Plated or Solder Coated	Shock (Specific Pulse)	100 g's, 6ms half sine
Hermetic Seal	1 x 10 <sup>-6</sup> atm-cm <sup>3</sup> /s	Weight	0.10 oz. (2.84) max.



Contact Load and Life Ratings		
LOAD LEVEL	CONTACT LOAD	CONTACT LIFE
Low level/Mechanical	10-50 $\mu$ A at 10-50 mVdc or Peak AC	100,000 cycles rated life
		1,000,000 cycles unmonitored (Mechanical Life)
Intermediate Current	100mA at 28Vdc	50,000 cycles
High Level, Resistive	1.0A at 28Vdc	100,000 cycles
High Level, Inductive	200mA at 28Vdc, with 0.32H inductance	100,000 cycles
High Level, Lamp	100mA at 28Vdc	100,000 cycles
Overload, Resistive	2.0A at 28Vdc	100 cycles

*Specifications based on relay case being grounded, unless otherwise specified*

Static Contact Resistance or Voltage Drop				
Measurement Condition		Maximum Static Contact Resistance or Voltage Drop		
		Without attached spacer/ spreader pad	With M4 spacer pad at- tached	With M or M3 spreader pad attached
Initial		0.125 $\Omega$	0.135 $\Omega$	0.150 $\Omega$
Low Level Life	During test	33 $\Omega$ (1.65mVdc monitoring Level)		
	After 100,000 or 1,000,000 cycle life	0.175 $\Omega$	0.185 $\Omega$	0.200 $\Omega$
Intermediate Current	During test	1 $\Omega$ (100mVdc monitoring Level)		
	After 50,000	0.225 $\Omega$	0.235 $\Omega$	0.250 $\Omega$
High Level Life	During life	Voltage drop no more than 5% of open circuit voltage (1.4 Vdc monitoring level)		
	After 100,000 cycle life	0.225 $\Omega$	0.235 $\Omega$	0.250 $\Omega$
Overload	During test	Not Monitored		
	After 100 cycle life	0.225 $\Omega$	0.235 $\Omega$	0.250 $\Omega$

General Electrical Specifications	
Insulation Resistance	10,000 M $\Omega$ minimum at 500Vdc
	1,000M $\Omega$ minimum at 500Vdc between coil and case at +125°C
	1,000M $\Omega$ minimum at 500Vdc after 100 cycle overload
	100,000 cycle high life, or 50,000 intermediate current tests
Dielectric Strength	500Vrms $\pm$ 5% at 50 or 60Hz
	375Vrms at 50 or 60Hz after 100 cycle overload, 100,000 cycle high level life, or 50,000 intermediate current tests
Operate Time	2.0 ms maximum with rated coil voltage
Coil Transient Suppresion (Vdc)	1.0 max.
Block Integrity max. leakage current	1 $\mu$ A at 50Vdc
Breakdown Voltage	100Vdc min. at 10 $\mu$ A

**Series HR422/ HRS422**  
 DC up to 1 GHz  
 Magnetic Latching Space Grade DPDT Relay



Coil Data and Operating Characteristics of Basic Relays and of Relays with Optional Diode for Coil Transient Suppression				
Coil Voltage (Vdc)		Room Ambient Temperature (+25°C)		Over Temperature Range
Rated	Max	Coil Resistance (Ω) ±10%	Set/reset voltage (V d.c.) max	Pick-Up Voltage (Vdc) max.
5.0	6.0	61	2.8	3.5
6.0	8.0	120	3.5	4.5
9.0	12.0	280	5.3	6.8
12.0	16.0	500	7.0	9.0
18.0	24.0	1130	10.5	13.5
26.5	32.0	2000	14.2	18.0

Coil Data and Operating Characteristics of Relays with Optional Diodes for Coil Transient Suppression and Polarity Reversal Protection						
Coil Voltage (Vdc)		Room Ambient Temperature (+25°C)			Over Temperature Range	
Rated	Max	Coil Resistance (Ω) ±10%	Coil Circuit Current (mA 4/)		Set/reset voltage (V d.c.) max	Set/reset voltage (V d.c.) max
			Max	Min		
5.0	6.0	48	104.2	75.8	3.5	4.5
6.0	8.0	97	63.0	46.9	4.1	5.5
9.0	12.0	280	33.7	26.0	6.3	7.8
12.0	16.0	500	25.5	20.0	8.0	10.0
18.0	24.0	1130	17.2	13.7	11.6	14.5
26.5	32.0	2000	14.4	11.6	15.4	19.0

PART NUMBER	DESCRIPTION
HR422K	Magnetic-Latching, DPDT, TO-5 Space Grade Relay (HIREL), High Shock
HRS422K	Magnetic-Latching, DPDT, TO-5 Space Grade Relay (HIREL), High Shock, Surface Mount J-Leads

Teledyne Relays' HR/HRS422K Series relay is a Commercial Off-The Shelf (COTS) relay suitable for high reliability space flight applications. When purchased in accordance with Teledyne Relays' standard Hi-Rel Acceptance Test Procedure (ATP) the relays will meet the basic requirements of both the NASA Goddard Space Flight Center's S-311-P-754 Document and the European Space Agency's (ESA) SCC 3601 & 3602 Specifications. The HR/HRS422K Series has become the premier selection for space flight applications requiring low-level switching to dry circuits up to 1 Amp. Teledyne Relays' 50 year history of supplying relays to the spacecraft manufacturing community has supported 95% of all satellite programs worldwide. Relays may be supplied in accordance with the standard requirements of the Hi-Rel ATP or as specified by customer source control drawings. In addition to enhanced test and inspection at the relay level the individual piece parts are inspected to higher standards. Relay leads may be supplied in either gold (Au) or solder dipped finish. A variety of formed lead configurations performed by the factory are available. All Hi-Rel relays are supplied with full data packages in either hard copy or electronic format. Customer Source Inspection (CSI) may be performed during critical manufacturing and test points.

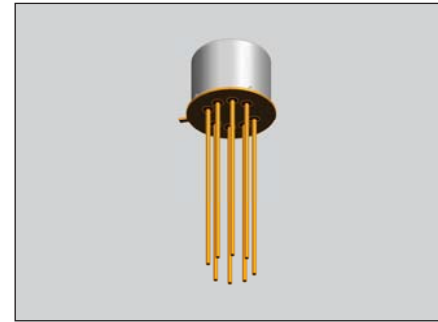

HR/HRS422K HIREL SERIES OVERVIEW
Design Based on QPL-Approved MIL-PRF-39016 Specification
Proven Space Flight Heritage
Meets the general requirements of NASA/GSFC, S311-P-754
Meets the general requirements of ESA/SCC General Specification 3601 & 3602
1x10 <sup>-6</sup> Leak Rate
Standard Acceptance Test Procedure (ATP) Meets both ESA and NASA Requirements
MIL-DTL-45204 Gold Plating
ANSI-J-STD-006 Requirements for Electric Grade Solder Alloys and Fluxed and Non-Fluxed Sold Solders for Electronic Soldering Applications
100% Small Particle/ Inspection (Millipore Cleaning)

STANDARD HIREL SCREENING	
100% Pre-Cap Inspection (Source Inspection Available)	Particle Impact Noise Detection (PIND)
Room Temperature Electrical Measurements	Internal Moisture
Solderability	Thermal Cycle/Miss Test (5,000 cycles total) + 2,500 at Room Temperature
Leak/Seal Test (1x10 <sup>-6</sup> ) cc/sec	Room Temperature Electrical Measurements
External Visual & Mechanical	Radiographic Inspection (X-Ray)
Vibration, Sinusoidal (30 G's)	Percent Defect Allowable, failure rate of lot (less than 10%)

ENVIRONMENTAL AND PHYSICAL CHARACTERISTICS			
Form Factor	2 Form C (DPDT)	Operating Temperature	-65°C to +125°C
Frequency Range	DC-3 GHz	Vibration (Sinusoidal)	30 g's 10 to 2500 Hz
Lead Finish	Gold Plated or Solder Coated	Shock (Specific Pulse)	100 g's, 6ms half sine
Hermetic Seal	1 x 10 <sup>-6</sup> atm-cm <sup>3</sup> /s	Weight	0.1 oz. (2.84) max.

Contact Load and Life Ratings		
LOAD LEVEL	CONTACT LOAD	CONTACT LIFE
Low level/Mechanical	10-50µA at 10-50 mVdc or Peak AC	100,000 cycles rated life
		1,000,000 cycles unmonitored (Mechanical Life)
Intermediate Current	100mA at 28Vdc	50,000 cycles
High Level, Resistive	1.0A at 28Vdc	100,000 cycles
High Level, Inductive	200mA at 28Vdc, with 0.32H inductance	100,000 cycles
High Level, Lamp	100mA at 28Vdc	100,000 cycles
Overload, Resistive	2.0A at 28Vdc	100 cycles

*Specifications based on relay case being grounded, unless otherwise specified*

Static Contact Resistance or Voltage Drop				
Measurement Condition		Maximum Static Contact Resistance or Voltage Drop		
		Without attached spacer/ spreader pad	With M4 spacer pad at- tached	With M/M3 spreader pad attached
Initial		0.125Ω	0.135Ω	0.150Ω
Low Level Life	During test	33Ω (1.65mVdc monitoring Level)		
	After 100,000 or 1,000,000 cycle life	0.175Ω	0.185Ω	0.200Ω
Intermediate Current	During test	1Ω (100mVdc monitoring Level)		
	After 50,000	0.225Ω	0.235Ω	0.250Ω
High Level Life	During life	Voltage drop no more than 5% of open circuit voltage (1.4 Vdc monitoring level)		
	After 100,000 cycle life	0.225Ω	0.235Ω	0.250Ω
Overload	During test	Not Monitored		
	After 100 cycle life	0.225Ω	0.235Ω	0.250Ω

General Electrical Specifications	
Insulation Resistance	10,000 MΩ minimum at 500Vdc
	1,000MΩ minimum at 500Vdc between coil and case at +125°C
	1,000MΩ minimum at 500Vdc after 100 cycle overload
	100,000 cycle high life, or 50,000 intermediate current tests
Dielectric Strength	500Vrms ±5% at 50 or 60Hz
	375Vrms at 50 or 60Hz after 100 cycle overload, 100,000 cycle high level life, or 50,000 intermediate current tests
Operate Time	2.0 ms maximum with rated coil voltage
Coil Transient Suppression (Vdc)	1.0 max.
Block Integrity max. leakage current	1µA at 50Vdc
Breakdown Voltage	100Vdc min. at 10µA

<b>Coil Data and Operating Characteristics of Basic Relays and of Relays with Optional Diode for Coil Transient Suppression</b>				
<b>Coil Voltage (Vdc)</b>		<b>Room Ambient Temperature (+25°C)</b>		<b>Over Temperature Range</b>
<b>Rated</b>	<b>Max</b>	<b>Coil Resistance (<math>\Omega</math>) <math>\pm 10\%</math></b>	<b>Set/reset voltage (V d.c.) max</b>	<b>Set/reset voltage (V d.c.) max</b>
5.0	6.0	61	2.8	3.5
6.0	8.0	120	3.5	4.5
9.0	12.0	280	5.3	6.8
12.0	16.0	500	7.0	9.0
18.0	24.0	1130	10.5	13.5
26.5	32.0	2000	14.2	18.0

# Series HR255/HR257

DC up to 3 GHz  
Magnetic Latching Space Grade DPDT Relay



PART NUMBER	DESCRIPTION
HR255, HR257	Magnetic-Latching, DPDT, Half-Size Crystal Can, Space Grade Relay (HIREL)
<p>Teledyne Relays' HR255/257 Series relay is a High Reliability Off-The Shelf (COTS) relay suitable for demanding space flight applications. When purchased in accordance with Teledyne Relays' standard Hi-Rel Acceptance Test Procedure (ATP) the relays will meet the basic requirements of both the NASA Goddard Space Flight Center's S-311-P-754 Document and the European Space Agency's (ESA) SCC 3601 &amp; 3602 Specifications. The HR255/HR257 Series has become the premier selection for space flight applications requiring low-level switching to dry circuits up to 2 Amp. Teledyne Relays' 50 year history of supplying relays to the spacecraft manufacturing community has supported 95% of all satellite programs worldwide. Relays may be supplied in accordance with the standard requirements of the Hi-Rel ATP or as specified by customer source control drawings. In addition to enhanced test and inspection at the relay level the individual piece parts are inspected to higher standards. Relay leads may be supplied in either gold (Au) or solder dipped finish. All Hi-Rel relays are supplied with full data packages in either hard copy or electronic format. Customer Source Inspection (CSI) may be performed during critical manufacturing and test points.</p>	

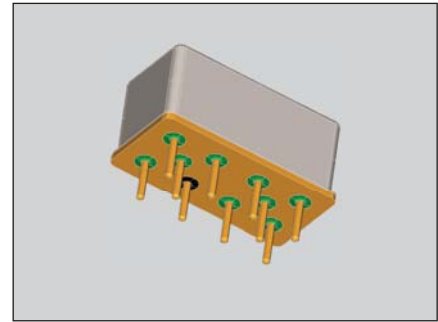

HR255/HR257 HIREL SERIES OVERVIEW
Design Based on QPL-Approved MIL-PRF-39016 Specification
Proven Space Flight Heritage
Meets the general requirements of NASA/GSFC, S311-P-754
Meets the general requirements of ESA/SCC General Specification 3601 & 3602
1x10 <sup>-6</sup> Leak Rate
Standard Acceptance Test Procedure (ATP) Meets both ESA and NASA Requirements
MIL-DTL-45204 Gold Plating
ANSI-J-STD-006 Requirements for Electric Grade Solder Alloys and Fluxed and Non-Fluxed Sold Solders for Electronic Soldering Applications
100% Small Particle/ Inspection (Millipore Cleaning)

STANDARD HIREL SCREENING (SEE DETAILED SUMMARY OF STANDARD SCREENING ON PAGE 4-9)	
100% Pre-Cap Inspection (Source Inspection Available)	Particle Impact Noise Detection (PIND)
Room Temperature Electrical Measurements	Internal Moisture
Solderability	Thermal Cycle/Miss Test (5,000 cycles total)
Leak/Seal Test (1x10 <sup>-6</sup> )	Room Temperature Electrical Measurements
External Visual & Mechanical	Radiographic Inspection (X-Ray)
Vibration, Sinusoidal (30 G's)	Percent Defect Allowable, failure rate of lot (less than 10%)

ENVIRONMENTAL AND PHYSICAL CHARACTERISTICS			
Form Factor	2 Form C (DPDT)	Operating Temperature	-65°C to +125°C
Frequency Range	DC-3 GHz	Vibration (Sinusoidal)	30 g's 10 to 2500 Hz
Lead Finish	Gold Plated or Solder Coated	Shock (Specific Pulse)	100 g's, 6ms half sine
Hermetic Seal	1 x 10 <sup>-6</sup> atm-cm <sup>3</sup> /s	Weight	0.46 oz. (13) max.

**MECHANICAL OUTLINE**

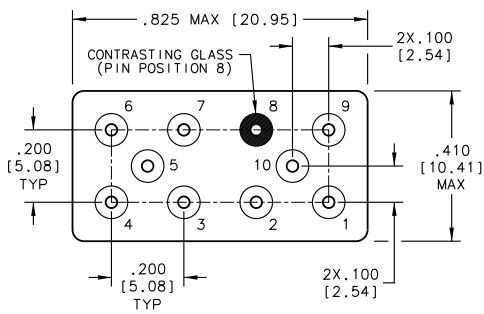
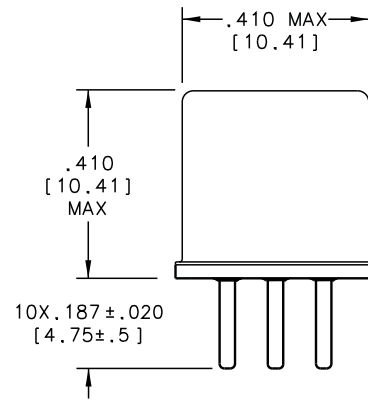
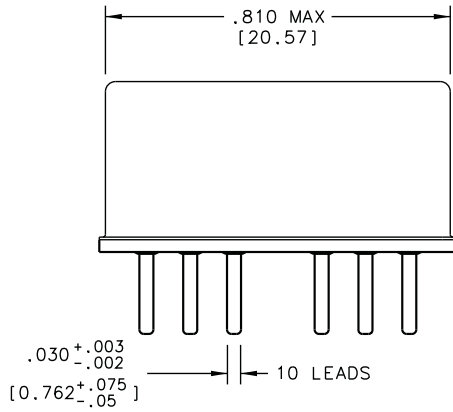

*HR257*

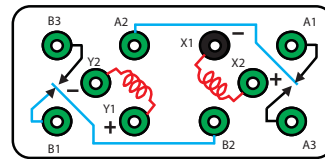

*HR255*

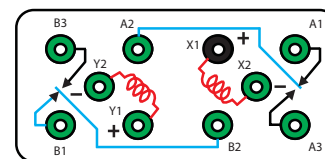

*DIMENSIONS ARE IN INCHES, (mm)*

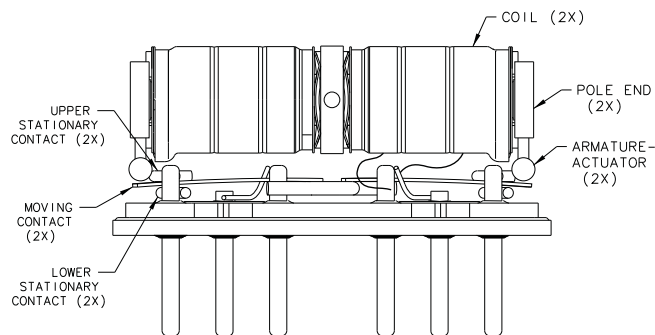



TYPICAL POWER PERFORMANCE CURVE

# Power Handling vs. Frequency

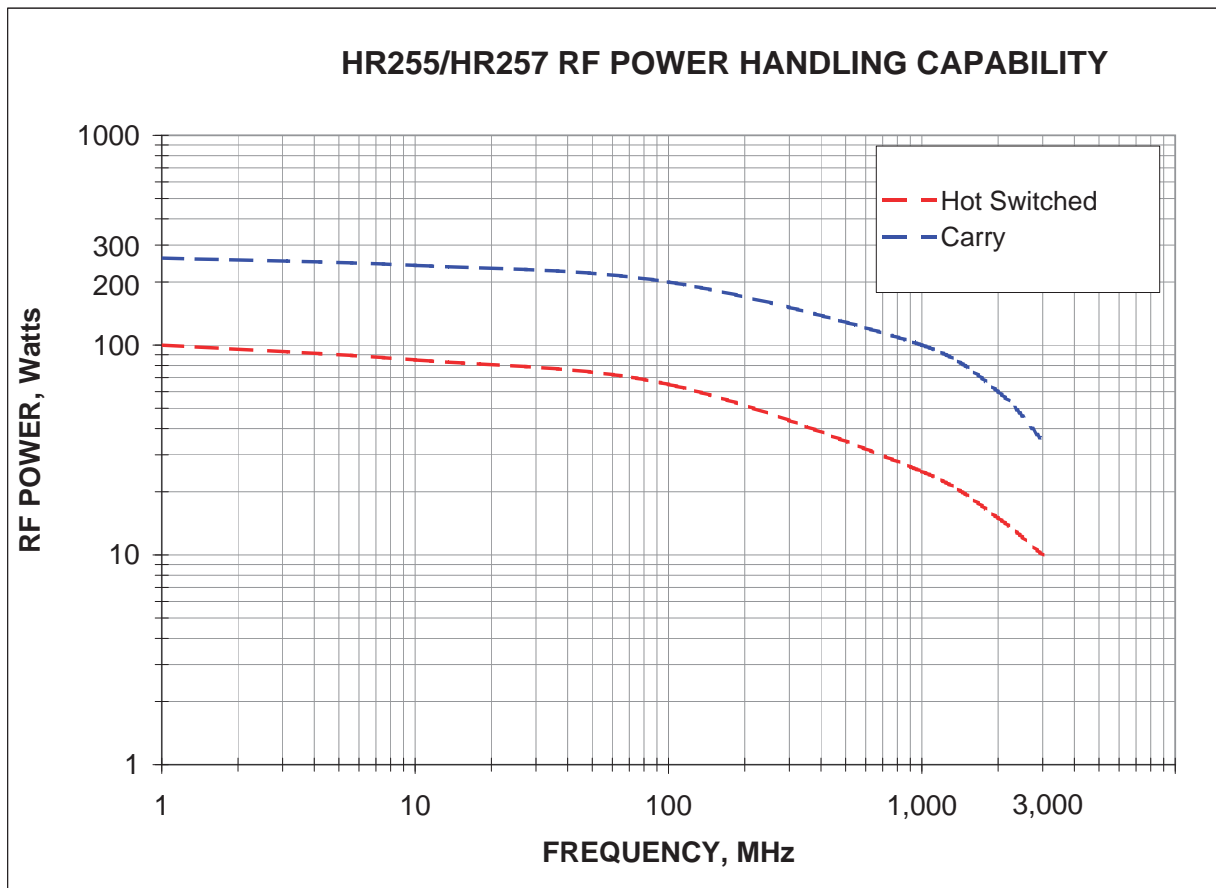

Test Notes:

1. Test condition: Ambient temperature and pressure.
2. Hot switched cycle rate: 1/3 Hz.
3. Matched load: 1.2:1 maximum

Contact Load and Life Ratings		
LOAD LEVEL	CONTACT LOAD	CONTACT LIFE
Low level/Mechanical	10-50 $\mu$ A at 10-50 mVdc or Peak AC	100,000 cycles rated life
		1,000,000 cycles unmonitored (Mechanical Life)
Intermediate Current	100mA at 28Vdc	50,000 cycles
High Level, Resistive	2.0A at 28Vdc	100,000 cycles
High Level, Inductive	750 mA at 28Vdc, with 0.20H inductance	100,000 cycles
High Level, Lamp	160mA at 28Vdc	100,000 cycles
Overload, Resistive	4.0A at 28Vdc	100 cycles

*Specifications based on relay case being grounded, unless otherwise specified*

Static Contact Resistance or Voltage Drop		
Measurement Condition		Maximum Static Contact Resistance or Voltage Drop
Initial		0.050 $\Omega$
Low Level Life	During test	33 $\Omega$ (1.65mVdc monitoring Level)
	After 100,000 or 1,000,000 cycle life	0.150 $\Omega$
Intermediate Current	During test	3 $\Omega$ (100mVdc monitoring Level)
	After 50,000	0.100 $\Omega$
High Level Life	During life	Voltage drop no more than 5% of open circuit voltage (1.4 Vdc monitoring level)
	After 100,000 cycle life	0.100 $\Omega$ .
Overload	During test	Not Monitored
	After 100 cycle life	0.100 $\Omega$

General Electrical Specifications	
Insulation Resistance	1,000 M $\Omega$ minimum at 500Vdc
	500M $\Omega$ minimum at 500Vdc between coil and case at +125°C
	500M $\Omega$ minimum at 500Vdc after 100 cycle overload
	100,000 cycle high life, or 50,000 intermediate current tests
Dielectric Strength	500Vrms $\pm$ 5% at 50 or 60Hz
	375Vrms at 50 or 60Hz after 100 cycle overload, 100,000 cycle high level life, or 50,000 intermediate current tests
Operate Time	3.0 ms maximum with rated coil voltage
Bounce Time	4.0 ms maximum with rated coil voltage

**Series HR255/HR257**  
 DC up to 3 GHz  
 Magnetic Latching Space Grade DPDT Relay



Coil Data and Operating Characteristics of Basic Relays						
Coil Voltage (Vdc)		Room Ambient Temperature (+25°C)			Over Temperature Range	
Rated	Max	Coil Resistance (Ω) ±10%	Latch/Reset Voltage (Vdc)		Latch/Reset Voltage (Vdc)	
			Max	Min	Max	Min
5.0	6.7	45	2.7	1.6	3.8	1.0
6.0	8.0	63	3.25	2.0	4.5	1.3
12.0	16.0	254	6.5	4.0	9.0	2.6
26.5	32.0	1000	13.0	8.0	18.0	5.2
48.0	64.0	3800	26.0	16.0	36.0	10.4

DETAILED SUMMARY OF STANDARD SCREENING	
100% Pre-Cap Inspection	Relays shall be examined to verify workmanship and cleanliness of the contact systems and motor mechanisms. Customer service inspection may be performed.
100% Small Particle Inspection (Millipore Clean)	In process inspection to further evaluate relay cleanliness by quality control inspectors prior to seal.
Room Temperature Electrical Measurements	
Coil Resistance	Relay coils shall be tested in accordance with MIL-STD-202, method 203. Limit of error of measuring apparatus: $\pm 2.5\%$
Coil Current	Rated voltage shall be applied to the coil supply terminals, and the coil circuit current shall be measured using suitable means. Measurement shall be made at room ambient temperature at rated voltage for 5 seconds maximum. Limit of error of measuring apparatus: $\pm 2.5\%$
Insulation Resistance	The insulation resistance shall be 10,000 M $\Omega$ or more, unless otherwise specified. After the overload, high level life, and intermediate current tests, the insulation resistance shall be 1,000 M $\Omega$ or more.
Dielectric Withstanding Voltage (Atmospheric Pressure)	Relays shall withstand the test voltage specified without damage, and there shall be no leakage current in excess of 100 $\mu$ A r.m.s. nor external evidence of damage due to arcing (air discharge), flash over (surface discharge), or insulation breakdown (puncture discharge). After the overload, high level life, and intermediate current tests, the dielectric withstanding voltage shall be at least 75 % of the allowable initial atmospheric value.
Static Contact Resistance	The static contact resistance shall not exceed 0.100 $\Omega$ .
Operating Characteristics	Pickup voltage as specified Drop-Out voltage as specified
Operate and Release Time	The operate and release time shall be as specified. For double-throw contacts, there shall be no closing of open contacts before all closed contacts have opened. This applies to either state of the relay.
Dynamic Contact Resistance	Contact bounce time as specified Contact stabilization time: The time to reach and maintain a static contact resistance state shall not exceed 2.0 ms, when specified. After overload, high level life, and intermediate current tests, contact bounce time shall be measured in lieu of contact stabilization time.
Solderability	
Relays shall be tested in accordance with MIL-STD-202, method 208.	Any termination that has less than 5 % of the total solder coated area (except the area within 0.050 in. from the emergence from the seating plane) dewetted, nonwetted, or with pinholes is acceptable. Other anomalies shall not be cause for rejection.
Seal	When tested, there shall be no leakage in excess of $1 \times 10^{-6}$ atm-cm <sup>3</sup> /s of air.
Visual Inspection (External)	Relays shall be uniform in quality, and be free from cracked and displaced parts, sharp edges, burrs and other defects that will affect life and serviceability

**DETAILED SUMMARY OF STANDARD SCREENING**

Sinusoidal Vibration	Relays shall be tested in accordance with MIL-STD-202, method 204. The following details and exceptions shall apply: Mounting method: Rigidly mounted by normal mounting means. Test condition D, except vibration level is the lesser of 0.195 inch double amplitude or 30 G peak, unless otherwise specified (see 3.1) and the frequency range shall be 10 Hz to 3,000 Hz. Contacts monitored to detect contact chatter and transfer
Random Vibration (If Specified)	Relays shall be tested in accordance with MIL-STD-202, method 214. The following details and exceptions shall apply: Mounting method: Rigidly mounted by normal mounting means. Test condition: Table I, test condition G (0.4 G <sup>2</sup> /Hz, 23.9 G r.m.s.). Contacts monitored to detect contact chatter and transfer.
Particle Impact Noise Detection (PIND)	Each relay shall be subjected to a PIND test capable of detecting the presence of loose particles within the relay enclosure in accordance with the requirements of Teledyne Relays' Procedure 0-40-824, which must be approved by the Orderer. Relays so tested shall exhibit no evidence of loose particle contamination.
Internal Moisture	Relays (coils de-energized) shall be at ambient room temperature prior to the start of test. The insulation resistance of all contact pins to case only shall be measured and observed. The relay coil shall be energized with 140 % of rated voltage for a period of 2½ minutes. For latching relays, this test shall be repeated for each coil. The insulation resistance of all contact pins to case only shall be verified a minimum of once each 30 seconds during this period.
Thermal Cycle	Each relay shall be subjected to 5 cycles of thermal shock in accordance with MIL-STD-202, Method 107, Test Condition B at the minimum and maximum rated temperatures (see 3.1). The following details and exceptions apply: The relay shall be de-energized during the first four temperature conditioning cycles, and the coil continuity shall be monitored continuously during this time. Monitoring current shall not exceed 300 MA. The relay shall be de-energized during low temperature. Step one of each temperature cycle shall be high temperature; step 3 of each temperature cycle shall be low temperature. At the end of each temperature extreme during the fifth temperature cycle (Steps 1 and 3), each relay shall be tested as follows: Non-latching relays shall be energized with maximum rated coil voltage (see 3.1) for one hour minimum. At the end of this time and while still at the high temperature extreme, perform the following electrical measurements: insulation resistance (at high temperature only), static contact resistance, operating characteristics, operate and release time and contact bounce time. Following the electrical measurements, perform the miss test. During Step 4 of the fifth cycle, stabilize the relays at room ambient for a minimum of 1 hour, with the coil(s) de-energized.
Miss Test (Run-in)	Relays shall be subjected to a 2,500 cycle run-in test at each of the applicable ambient temperatures. The following details apply: Coil energization conditions: The coil(s) shall be energized and cycled at maximum rated voltage (see 3.1). Cycling Rate: 1 to 5 Hz. Contact loading: Relays shall have the contacts loaded as follows: open circuit load voltage 10 to 50 mV d.c. or peak a.c., load current 10 to 50 µA Monitoring: The contact voltage drop or resistance for each pair of mated contacts shall be monitored during 40 % minimum of each "on" and each "off" period, within the latter 50 % of each period. The test equipment shall record all relay failures

DETAILED SUMMARY OF STANDARD SCREENING	
Miss Test (cont'd)	Number of misses allowed: None. Applicable Ambient Temperature: Ambient High Temperature +125 ° C Ambient Low Temperature - 65 ° C Ambient Room Temperature +25 ° C
Radiographic Inspection (X-Ray)	Each relay shall be examined to determine proper internal construction in accordance with the requirements of Teledyne Relays' Procedure 0-40-193, which must be approved by the Orderer.
Percent Defect Allowable	Check for failure lot rate (Must be less than 10%)

# NEW COMPACT, LIGHT WEIGHT, EMR SWITCH MATRIX



**TELEDYNE**  
COAX SWITCHES  
Everywhere you look™

## Teledyne Relays offers Compact Electromechanical Switch Matrices?

### ADVANTAGES

- *Lower Power (Magnetic Latching Relays)*
- *80% Less Weight than Connectorized Switches*
- *Lower Cost Switching Solution*
- *Space Savings and Cable Length Reduction*

### FEATURES

- *Custom Configurations*
- *Suitable for L, S, and Partial C Band Communication Applications*
- *QPL-Approved MIL-PRF-39016*
- *Contact Load Rating: 1A @28Vdc*

### HI-REL SCREENING

- *100% Pre-Cap Inspection*
- *Room Temperature Electricals*
- *Leak/Seal Test*
- *External Visual and Mechanical Inspection*
- *Vibration (30 g's sine)*
- *Particle Impact Noise Detection*
- *Internal Moisture*
- *Thermal Cycles*
- *X-Ray*

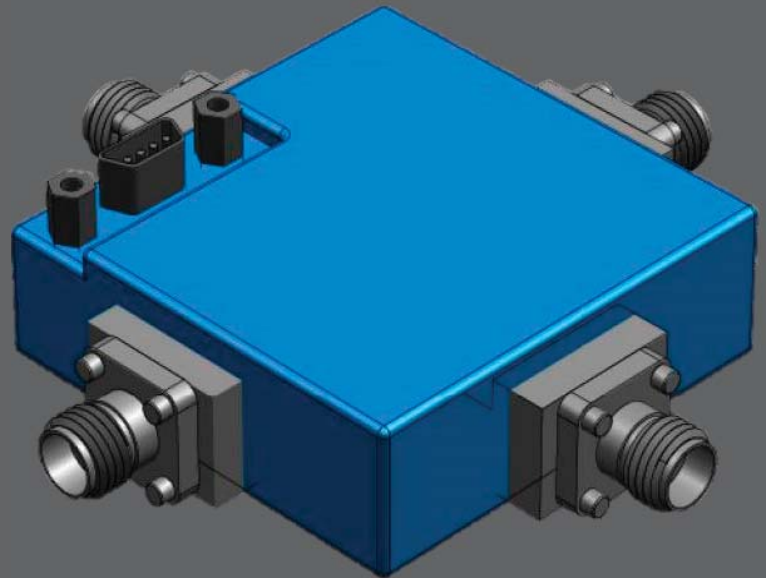

Concept Render

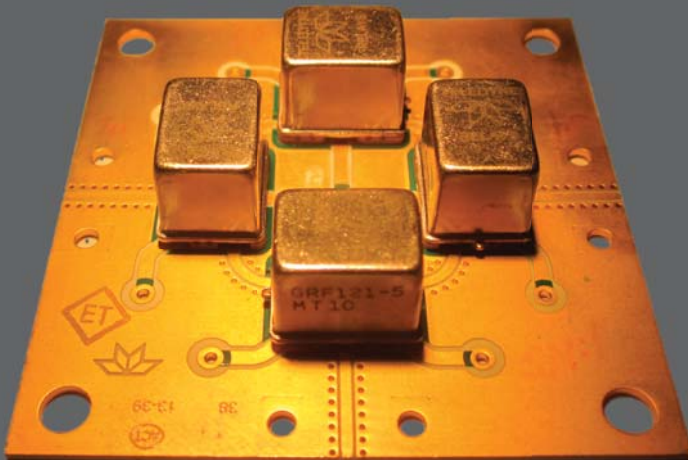



PART NUMBER	DESCRIPTION
H-33S	Space Grade Latching SPDT, DC up to 26.5 GHz

Teledyne Coax Switches' "H-33S Series" RF Coaxial Switch is a High Reliability Off-The-Shelf product suitable for demanding space flight applications. When purchased in accordance with Teledyne Coax Switches' standard Hi-Rel Acceptance Test Procedure (ATP), Document No. 0-43-058, the switches will meet the basic requirements for space flight applications. The "H-33S Series" has become the premier selection for space flight applications requiring RF switching capability. Teledyne Relays' 50 year history of supplying high reliability products to the space craft manufacturing community has supported 95% of all satellite programs worldwide. The RF Coax Switches may be supplied in accordance with the standard requirements of the Hi-Rel ATP or as specified by customer source control drawings. In addition to enhanced test and inspection at the relay level the individual piece parts are inspected to higher standards. The switches may be supplied with standard SMA connectors or as specified by customer requirements. All Hi-Rel RF Coaxial Switches are supplied with full data packages in either hard copy or electronic format. Customer Source Inspection (CSI) may be performed during critical manufacturing and test points. Test Readiness Review (TRR) and Document Review Board (DRB) meeting will be supported as required and Qualification Test Programs and Procedures can be customized as necessary.

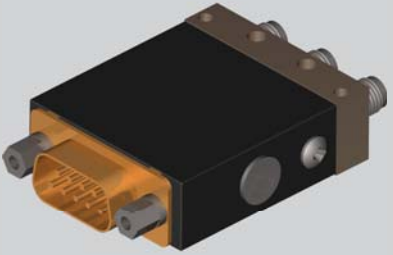

H-33S HIREL SERIES OVERVIEW	
Design Based on Teledyne's High Reliability Off-The-Shelf Space program	
Proven Space Flight Heritage	
Fully Defined Pre-Seal Internal Screening Plan	
Fully Defined Post-Seal Standard Acceptance Test Plan and Procedure (ATP)	
ANSI-J-STD-006 Requirements for Electric Grade Solder Alloys and Fluxed and Non-Fluxed Solid Solders for Electronic Soldering Applications	
STANDARD HIREL SCREENING	
Pre-Seal - Standard Internal Screening Plan	Operational Test at Temperature
Thermal Shock	Physical and Mechanical Inspection
Initial Functional	QA/CSI Sign-off
Run-In at Room Ambient	Final Functional
Vibration	

ENVIRONMENTAL AND PHYSICAL CHARACTERISTICS	
Operating Temperature	-55°C to +85°C
Vibration (MIL-STD-202 Method 214, Condition D, non-operating)	10 g's RMS
Shock (MIL-STD-202 Method 213, Condition D, non-operating)	500 g's
Finish	Electroless Nickel Plate
Life Cycle, minimum	100,000 cycles
Connector Type	SMA
Weight	2.12 oz. (60g) (max.)

ELECTRICAL CHARACTERISTICS	
Form Factor	SPDT, break before make
Frequency Range	L, S, C, X, KU, K
RF Leakage	-95 dBc @ 300 MHz
Characteristic Impedance	50 Ohms
Operate Time	10 ms (max.)
Release Time	10 ms (max.)
Actuation Voltage Available	28 V
Actuation Current, max. @ ambient	90 mA

PERFORMANCE CHARACTERISTICS						
Frequency Option	F2 (L-BAND) DC-2 GHz	F4 (S-BAND) 2-4 GHz	F8 (C-BAND) 4-8 GHz	F12 (X-BAND) 8-12 GHz	F18 (KU-BAND) 12-18 GHz	F26 (K-BAND) 18-26 GHz
Insertion Loss, dB, max.	0.15	-0.25	0.35	0.3	0.4	0.65
Isolation, dB, min.	80	70	70	70	60	55
VSWR, max.	1.5:1	1.25:1	1.30:1	1.35:1	1.40:1	1.65:1

# Series H-33S

DC up to 26.5 GHz  
Latching SPDT Space Grade Coaxial Switch

PART NUMBER	DEFAULT CONFIGURATION
H-33S6C-F2	SMA Female Connections
H-33S6C-F4	
H-33S6C-F8	Transient Suppression
H-33S6C-F12	
H-33S6C-F18	9-PIN D-Sub Connector
H-33S6C-F26	
	Indicator Contacts
	Venting Screen

## MECHANICAL OUTLINE

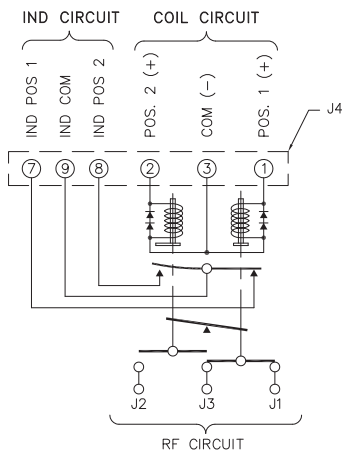
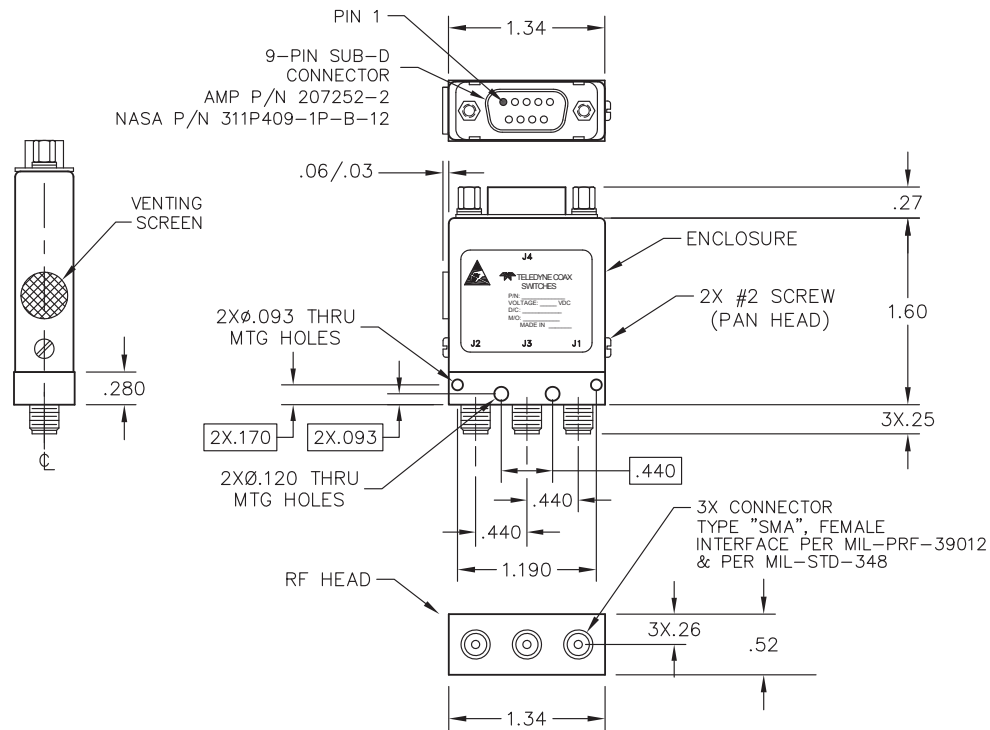

**SCHEMATIC**

POSITION	VOLTAGE	RF CONTINUITY	INDICATOR
POS.1	1 & 3	J1-J3	7 & 9
POS.2	2 & 3	J2-J3	8 & 9

PART NUMBER	DESCRIPTION
H-32N	Space Grade Latching SPDT, DC up to 12GHz

Teledyne Coax Switches' "H-32N Series" RF Coaxial Switch is a High Reliability Off-The-Shelf product suitable for demanding space flight applications. When purchased in accordance with Teledyne Coax Switches' standard Hi-Rel Acceptance Test Procedure (ATP), Document No. 0-43-058, the switches will meet the basic requirements for space flight applications. The "H-32N Series" has become the premier selection for space flight applications requiring RF switching capability. Teledyne Relays' 50 year history of supplying high reliability products to the space craft manufacturing community has supported 95% of all satellite programs worldwide. The RF Coax Switches may be supplied in accordance with the standard requirements of the Hi-Rel ATP or as specified by customer source control drawings. In addition to enhanced test and inspection at the relay level the individual piece parts are inspected to higher standards. The switches may be supplied with standard Type N connector or as specified by customer requirements. All Hi-Rel RF Coaxial Switches are supplied with full data packages in either hard copy or electronic format. Customer Source Inspection (CSI) may be performed during critical manufacturing and test points. Test Readiness Review (TRR) and Document Review Board (DRB) meeting will be supported as required and Qualification Test Programs and Procedures can be customized as necessary.

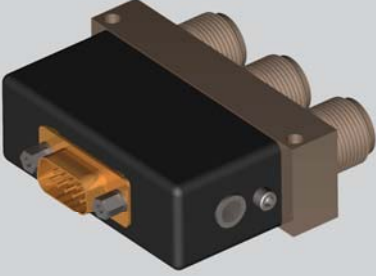

H-32N HIREL SERIES OVERVIEW	
Design Based on Teledyne's High Reliability Off-The-Shelf Space program	
Proven Space Flight Heritage	
Fully Defined Pre-Seal Internal Screening Plan	
Fully Defined Post-Seal Standard Acceptance Test Plan and Procedure (ATP)	
ANSI-J-STD-006 Requirements for Electric Grade Solder Alloys and Fluxed and Non-Fluxed Solid Solders for Electronic Soldering Applications	
STANDARD HIREL SCREENING	
Pre-Seal - Standard Internal Screening Plan	Operational Test at Temperature
Thermal Shock	Physical and Mechanical Inspection
Initial Functional	QA/CSI Sign-off
Run-In at Room Ambient	Final Functional
Vibration	

ENVIRONMENTAL AND PHYSICAL CHARACTERISTICS	
Operating Temperature	-55°C to +85°C
Vibration (MIL-STD-202 Method 214, Condition D, non-operating)	10 g's RMS
Shock (MIL-STD-202 Method 213, Condition D, non-operating)	500 g's
Finish	Electroless Nickel Plate
Life Cycle, minimum	100,000 cycles
Connector Type	Type N
Weight	7.05 oz. (200g) (max.)

ELECTRICAL CHARACTERISTICS	
Form Factor	SPDT, break before make
Frequency Range	L, S, C, X
RF Leakage	-95 dBc, 10dBm, @300 MHz
Characteristic Impedance	50 Ohms
Operate Time	10 ms (max.)
Release Time	10 ms (max.)
Actuation Voltage Available	28 V
Actuation Current, max. @ ambient	90 mA

PERFORMANCE CHARACTERISTICS				
Frequency Option	F2 (L-BAND) DC-2 GHz	F4 (S-BAND) 2-4 GHz	F8 (C-BAND) 4-8 GHz	F12 (X-BAND) 8-12 GHz
Insertion Loss, dB, max.	0.2	0.3	0.4	0.55
Isolation, dB, min.	70	70	70	60
VSWR, max.	1.2:1	1.3:1	1.3:1	1.6:1

**Series H-32N**  
 DC up to 12 GHz  
 Latching SPDT Space Grade Coaxial Switch

PART NUMBER	DEFAULT CONFIGURATION
H-32N6C-F2	Type N Female Connections
H-32N6C-F4	Transient Suppression
H-32N6C-F8	9-PIN D-Sub Connector
H-32N6C-F12	Indicator Contacts
H-32N6C-F18	Venting Screen

**MECHANICAL OUTLINE**

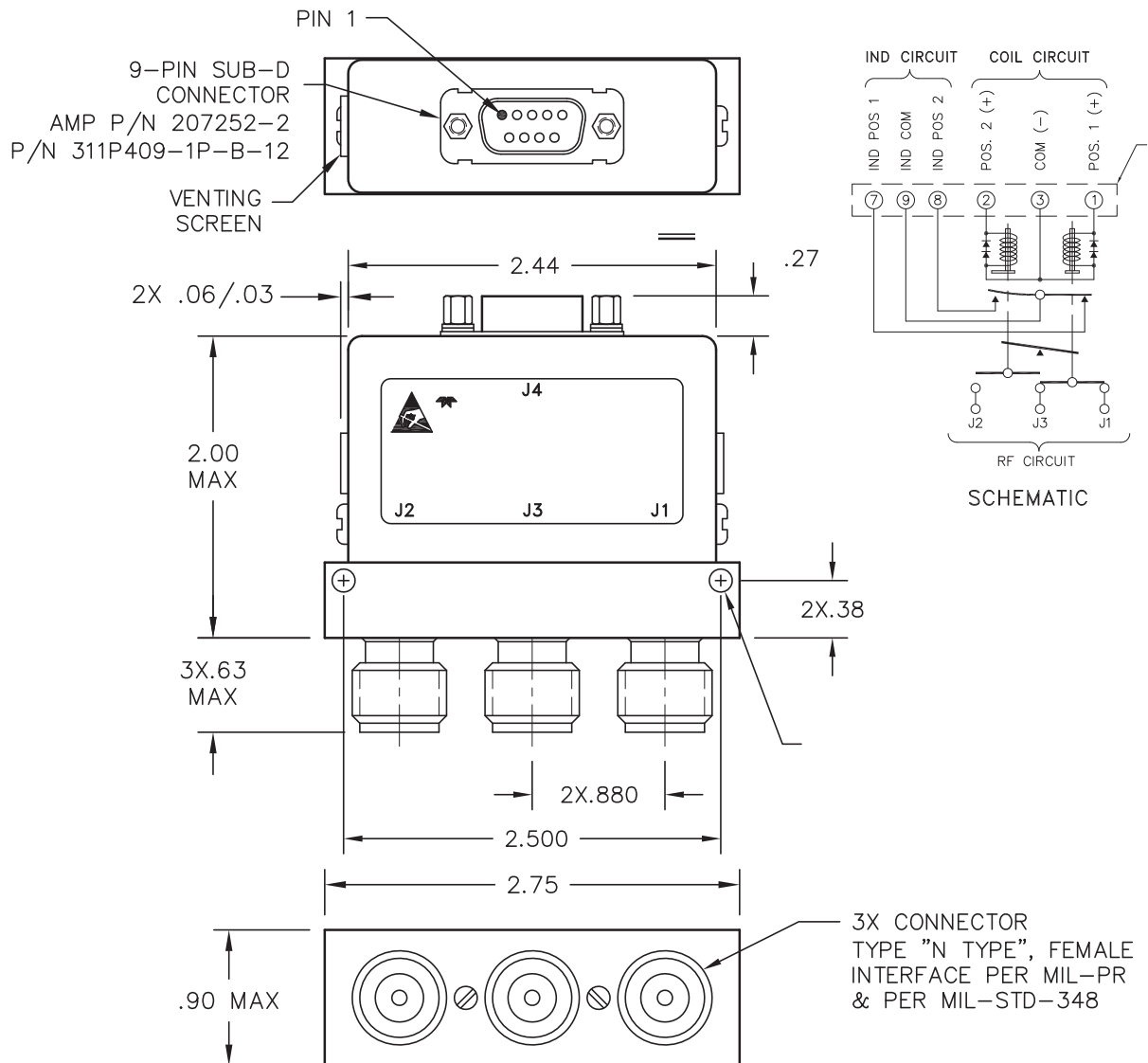

PART NUMBER	DESCRIPTION
H-37S	Space Grade Latching Transfer, DC up to 18GHz
<p>Teledyne Coax Switches' "H-37S Series" RF Coaxial Switch is a High Reliability Off-The-Shelf product suitable for demanding space flight applications. When purchased in accordance with Teledyne Coax Switches' standard Hi-Rel Acceptance Test Procedure (ATP), Document No. 0-43-058, the switches will meet the basic requirements for space flight applications. The "H-37S Series" has become the premier selection for space flight applications requiring RF switching capability. Teledyne Relays' 50 year history of supplying high reliability products to the space craft manufacturing community has supported 95% of all satellite programs worldwide. The RF Coax Switches may be supplied in accordance with the standard requirements of the Hi-Rel ATP or as specified by customer source control drawings. In addition to enhanced test and inspection at the relay level the individual piece parts are inspected to higher standards. The switches may be supplied with standard SMA connectors or as specified by customer requirements. All Hi-Rel RF Coaxial Switches are supplied with full data packages in either hard copy or electronic format. Customer Source Inspection (CSI) may be performed during critical manufacturing and test points. Test Readiness Review (TRR) and Document Review Board (DRB) meeting will be supported as required and Qualification Test Programs and Procedures can be customized as necessary.</p> 	

H-37S HIREL SERIES OVERVIEW	
Design Based on Teledyne's High Reliability Off-The-Shelf program	
Proven Space Flight Heritage	
Fully Defined Pre-Seal Internal Screening Plan	
Fully Defined Post-Seal Standard Acceptance Test Plan and Procedure (ATP)	
ANSI-J-STD-006 Requirements for Electric Grade Solder Alloys and Fluxed and Non-Fluxed Solid Solders for Electronic Soldering Applications	
STANDARD HIREL SCREENING	
Pre-Seal - Standard Internal Screening Plan	Operational Test at Temperature
Thermal Shock	Physical and Mechanical Inspection
Initial Functional	QA/CSI Sign-off
Run-In at Room Ambient	Final Functional
Vibration	

ENVIRONMENTAL AND PHYSICAL CHARACTERISTICS	
Operating Temperature	-55°C to +85°C
Vibration (MIL-STD-202 Method 214, Condition D, non-operating)	10 g's RMS
Shock (MIL-STD-202 Method 213, Condition D, non-operating)	500 g's
Finish	Electroless Nickel Plate
Life Cycle, minimum	100,000 cycles
Connector Type	SMA
Weight	4.5 oz. (127.57g) (max.)

ELECTRICAL CHARACTERISTICS	
Form Factor	Transfer, break before make
Frequency Range	L, S, C, X, KU
RF Leakage	-70 dBc @ 10 dBm
Characteristic Impedance	50 Ohms
Operate Time	10 ms (max.)
Release Time	10 ms (max.)
Actuation Voltage Available	28 V
Actuation Current, max. @ ambient	90 mA

PERFORMANCE CHARACTERISTICS					
Frequency Option	F2 (L-BAND) DC-2 GHz	F4 (S-BAND) 2-4 GHz	F8 (C-BAND) 4-8 GHz	F12 (X-BAND) 8-12 GHz	F18 (KU-BAND) 12-18 GHz
Insertion Loss, dB, max.	0.15	0.25	0.35	0.5	0.65
Isolation, dB, min.	80	70	70	70	60
VSWR, max.	1.15:1	1.3:1	1.35:1	1.4:1	1.6:1

PART NUMBER	DEFAULT CONFIGURATION
H-37S6C-F2	SMA Female Connections
H-37S6C-F4	Transient Suppression
H-37S6C-F8	9-PIN D-Sub Connector
H-37S6C-F12	Indicator Contacts
H-37S6C-F18	Venting Screen

**MECHANICAL OUTLINE**

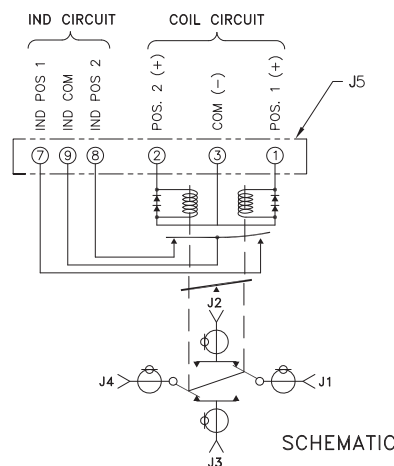
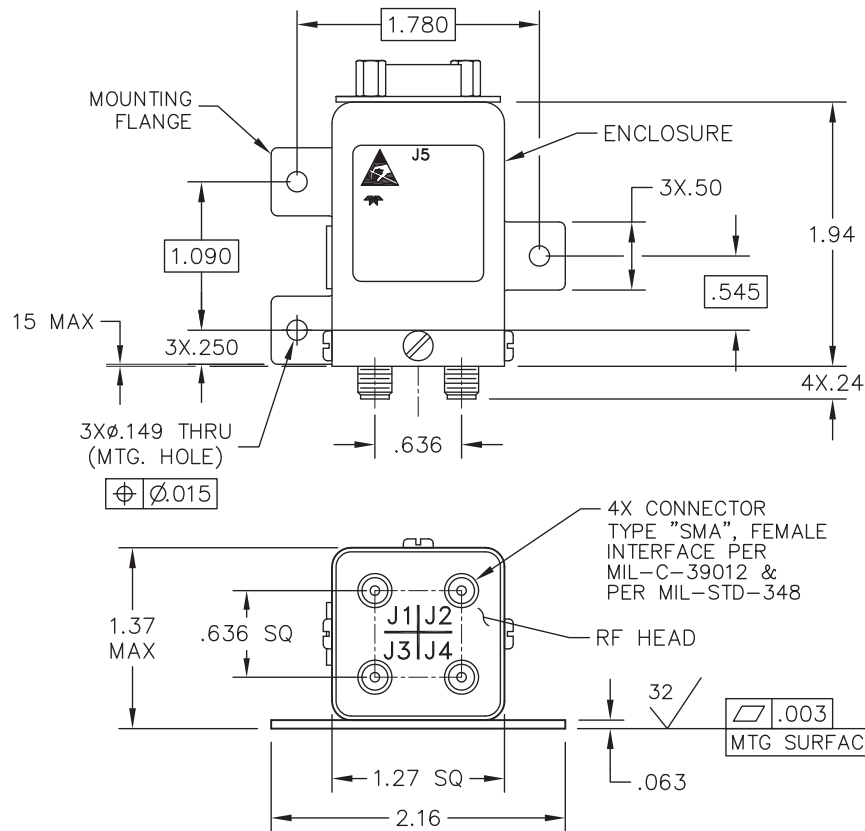

POSITION	VOLTAGE	RF CONTINUITY	INDICATOR
POS.1	1 & 3	J1-J3, J2-J4	7 & 9
POS.2	2 & 3	J1-J2, J3-J4	8 & 9

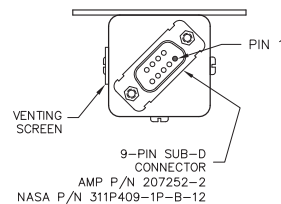

PART NUMBER	DESCRIPTION
H-47N	Space Grade Latching Transfer, DC up to 12GHz
<p>Teledyne Coax Switches' "H-47N Series" RF Coaxial Switch is a High Reliability Off-The-Shelf product suitable for demanding space flight applications. When purchased in accordance with Teledyne Coax Switches' standard Hi-Rel Acceptance Test Procedure (ATP), Document No. 0-43-058, the switches will meet the basic requirements for space flight applications. The "H-47N Series" has become the premier selection for space flight applications requiring RF switching capability. Teledyne Relays' 50 year history of supplying high reliability products to the space craft manufacturing community has supported 95% of all satellite programs worldwide. The RF Coax Switches may be supplied in accordance with the standard requirements of the Hi-Rel ATP or as specified by customer source control drawings. In addition to enhanced test and inspection at the relay level the individual piece parts are inspected to higher standards. The switches may be supplied with standard Type N connector or as specified by customer requirements. All Hi-Rel RF Coaxial Switches are supplied with full data packages in either hard copy or electronic format. Customer Source Inspection (CSI) may be performed during critical manufacturing and test points. Test Readiness Review (TRR) and Document Review Board (DRB) meeting will be supported as required and Qualification Test Programs and Procedures can be customized as necessary.</p>	

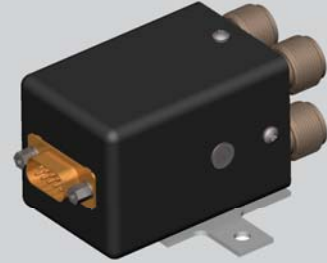

H-47N HIREL SERIES OVERVIEW	
Design Based on Teledyne's High Reliability Off-The-Shelf Space program	
Proven Space Flight Heritage	
Fully Defined Pre-Seal Internal Screening Plan	
Fully Defined Post-Seal Standard Acceptance Test Plan and Procedure (ATP)	
ANSI-J-STD-006 Requirements for Electric Grade Solder Alloys and Fluxed and Non-Fluxed Solid Solders for Electronic Soldering Applications	
STANDARD HIREL SCREENING	
Pre-Seal - Standard Internal Screening Plan	Operational Test at Temperature
Thermal Shock	Physical and Mechanical Inspection
Initial Functional	QA/CSI Sign-off
Run-In at Room Ambient	Final Functional
Vibration	

ENVIRONMENTAL AND PHYSICAL CHARACTERISTICS	
Operating Temperature	-55°C to +85°C
Vibration (MIL-STD-202 Method 214, Condition D, non-operating)	10 g's RMS
Shock (MIL-STD-202 Method 213, Condition D, non-operating)	500 g's
Finish	Electroless Nickel Plate
Life Cycle, minimum	100,000 cycles
Connector Type	Type N
Weight	6.5 oz. (184.27g) (max.)

ELECTRICAL CHARACTERISTICS	
Form Factor	Transfer, break before make
Frequency Range	L, S, C, X
Characteristic Impedance	50 Ohms
RF Leakage	-70 dBc @ 4GHz
Operate Time	10 ms (max.)
Release Time	10 ms (max.)
Actuation Voltage Available	28 V
Actuation Current, max. @ ambient	90 mA

PERFORMANCE CHARACTERISTICS				
Frequency Option	F2 (L-BAND) DC-2 GHz	F4 (S-BAND) 2-4 GHz	F8 (C-BAND) 4-8 GHz	F12 (X-BAND) 8-12 GHz
Insertion Loss, dB, max.	0.2	0.3	0.4	0.6
Isolation, dB, min.	70	70	60	60
VSWR, max.	1.3:1	1.3:1	1.4:1	1.65:1



**Series H-47N**  
 DC up to 12 GHz  
 Latching Transfer Space Grade Coaxial Switch

PART NUMBER	DEFAULT CONFIGURATION
H-47N6C-F2	N Female Connections
H-47N6C-F4	Transient Suppression
H-47N6C-F8	9-PIN D-Sub Connector
H-47N6C-F12	Indicator Contacts
H-47N6C-F12	Venting Screen

**MECHANICAL OUTLINE**

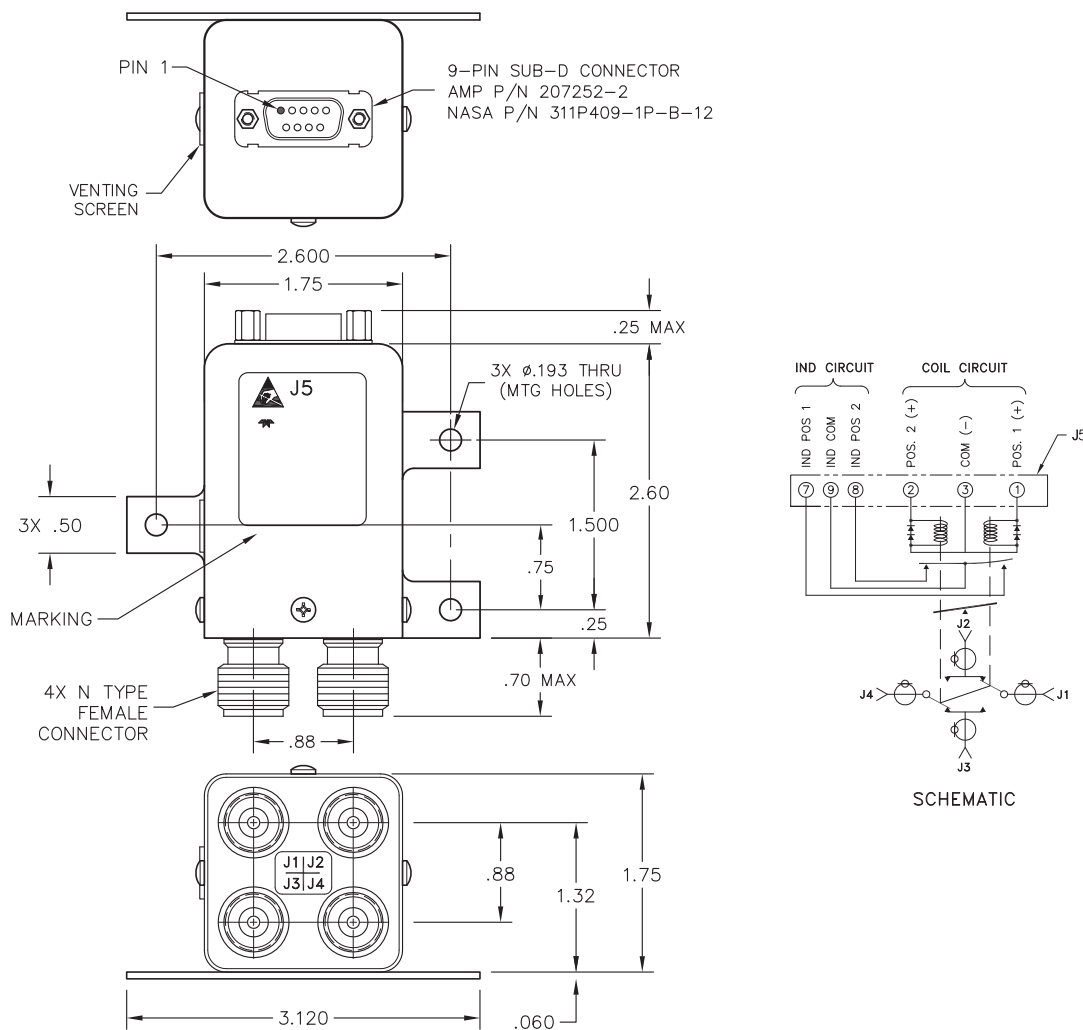

## ATP COAX Test Flow

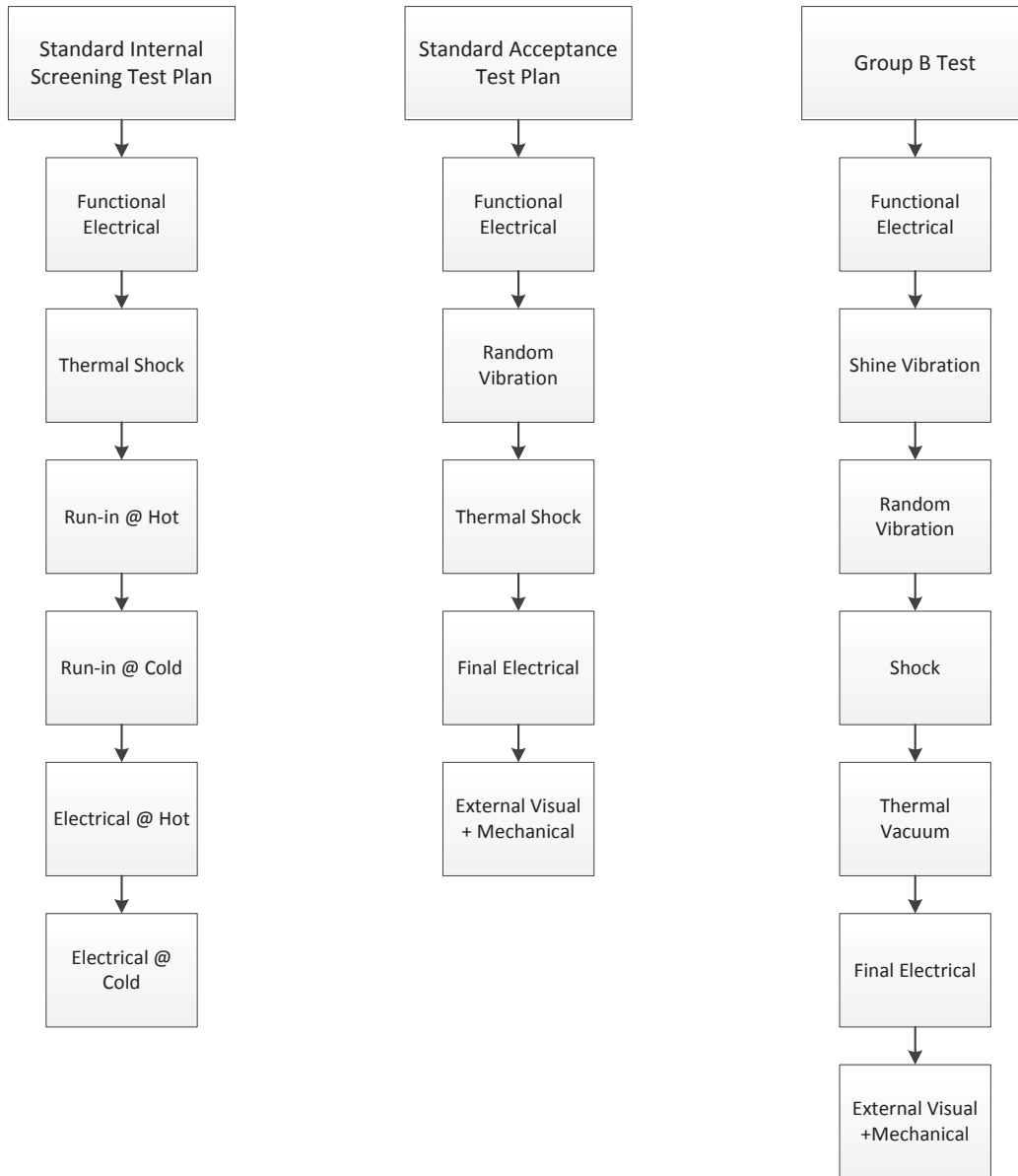

DETAILED SUMMARY OF STANDARD SCREENING	
Pre-Seal - Inspection	100% Visual Inspection
Electrical Test at Room Ambient	VSWR Insertion Loss Isolation, Minimum Operating Voltage Switching Time Coil Resistance
Thermal Shock	5 cycles 1-hour dwell at each temperature -55°C and +85°C
Run In at Room Temperature Extremes	Temperature, per Teledyne standard or customer's requirement 500 actuations at each temperature extreme 250 actuation, non-monitor 250 actuation, contact-resistance monitor
Electrical Test at Temperatures	VSWR Insertion Loss Isolation Minimum Operation Voltage Switching Time Coil Resistance Contact Resistance
Vibration, Random	
Post-vibration Functional	VSWR Insertion Loss Minimum Operating Voltage Minimum Switching Time RF Contact Resistance Indicator Contact Resistance (if applicable)
Final Functional at Room Ambient	VSWR Insertion Loss Isolation Minimum Operating Voltage Minimum Switching Time RF Contact Resistance Indicator Contact Resistance Coil Resistance
Physical and Mechanical Inspection	
QA/CSI Sign-off	
In addition to the standard environmental tests, upon customer request, the following tests may be performed at any time during acceptance test:	<input type="checkbox"/> Mechanical Shock <input type="checkbox"/> Thermal Vacuum <input type="checkbox"/> RF Leakage <input type="checkbox"/> RF Susceptibility <input type="checkbox"/> Run-in Cycling <input type="checkbox"/> Switching Life Test <input type="checkbox"/> X-ray

## What is a switch block?

A switch block is a system composed of multiple individual space qualified switches connected to achieve multi-input and multi-output configurations, allowing you to reduce space. A switch block can consist of SPDT and Transfer switches to achieve customized switching configurations.

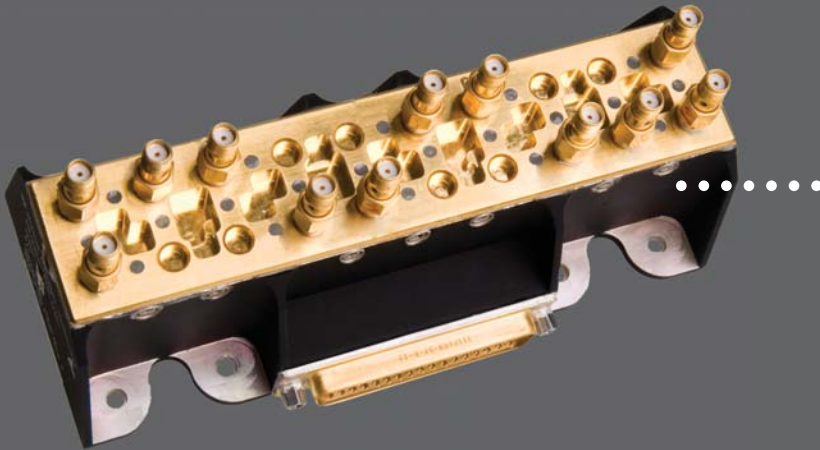

## Teledyne Switch Blocks Feature:

- D-Connectors
- Custom Mounting
- Venting (Pressure Control)
- Custom switching patterns
- Transient Suppression (Diode Protection)
- Custom Telemetry Interfaces/Connections

## Program Oriented Design Review

- Compliance Matrix
- Mechanical Layout
- Thermal Analysis
- Cascade Analysis with tolerances
- Power Analysis

## Program Oriented Development Engineering

- Qualification Test Procedure
- Qualification Testing Report
- Acceptance Test Procedure
- Complete Data Package
- Configuration and Data Management (traceability and sustainment/logistics support)

# Switch Blocks

Teledyne's Switch Blocks offer switching systems for space flight applications. Teledyne's 50 years experience in switching technology make it the most reliable Switch Block system on the market.

## Verification of Performance and Design:

- Verification Model
- Engineering Model
- Engineering Qualification Model
- Protoflight Model
- Flight Model
- Temperature

## Teledyne Switch Blocks are available with a variety of RF connector types:

- SMA
- TNC
- Type N



## Teledyne Switch Blocks offer:

- 3D Modeling
- EMC Compatability
- Low PIM
- Multipaction
- Low RF Leakage

## Additional optional capabilities:

### Environmental testing:

- Pyro Shock
- Radiation Hardness
- Acceleration
- Grounding/Bonding
- Temperature
- Vibration, Random and Sine
- Electrostatic Discharge (ESD)
- Humidity
- Pressurization/Depressurization

# Lead Forming Options

## M SPREADER PAD

*The M spreader pad is used to create separation between the relay and a PCB to avoid potential short circuits from circuit traces lying directly underneath relay header.*

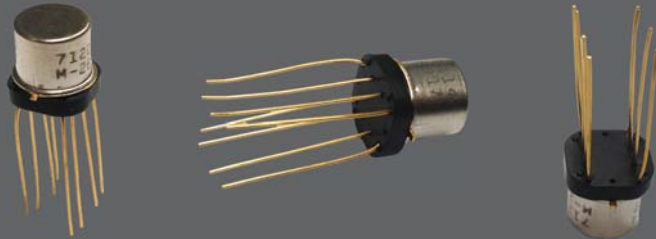

## M2 SPREADER PAD

*The M2 spreader pad is used to reconfigure the TO-5 package relay that has a circular footprint into a .100" spacing, IC-type pattern. It also serves to create separation between the relay and a PCB to avoid potential short circuits from circuit traces lying directly underneath relay header.*

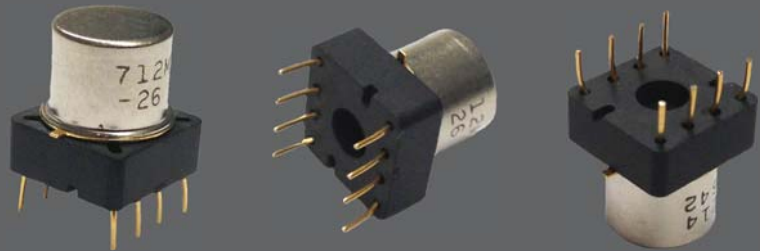

## M3 SPREADER PAD

*The M3 spreader pad is used to create separation between the relay and a PCB to avoid potential short circuits from circuit traces lying directly underneath relay header.*



# Options

## M4 SPACER PAD

*The M4 spacer pad creates a slight separation between the relay and a PCB to improve the removal of residue while undergoing various cleaning processes.*



---

## SURFACE-MOUNT J-LEADS AND CUSTOM LEADS

*The surface-mount J-leads are a standard footprint option. Teledyne also has the capability to form custom leads to accommodate unique footprints. Teledyne has been offering surface-mount space products for the last 10 years.*





Teledyne Relays maintains a vertically integrated organization in order to provide consistent quality throughout the manufacturing process while maintaining timely scheduling. Teledyne Relays' self-sufficiency is evident in every discipline of the organization; Manufacturing, Environmental Test, Quality Assurance and Engineering.



**CNC EQUIPMENT**

Manufacturing – Teledyne Relays possesses the capabilities to manufacture 75% of all piece part requirements for the electromechanical product line. Our capabilities include metal stamping, header firing line, full metal plating shop for precious metal plating and coil winding all supported by a full machine shop with Computer Numeric Controlled (CNC) milling machines.



**FULL MACHINE SHOP**

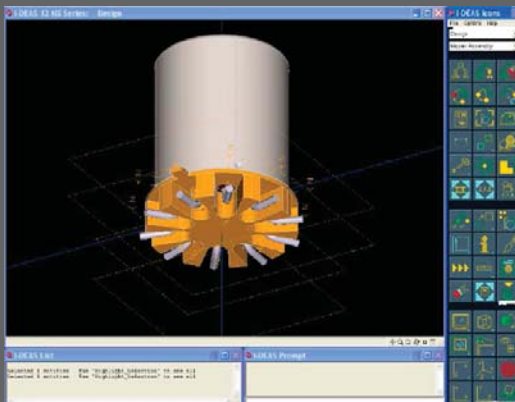

**ENGINEERING SUPPORT**

Engineering – Teledyne Relays employs a full complement of engineering staff to perform sustaining and research and design activities. The engineering staff draws on an average of ten years' experience in both the electro-mechanical and RF product fields. They are equipped with the latest software in Computer Aided Design (CAD), and Failure Analysis.



**LIFE TEST EQUIPMENT**



**AUTOMATED TEST EQUIPMENT**

# And Capabilities



**PRECIOUS METAL PLATING**

Quality Assurance – Teledyne Relays is AS/EN/ JISQ9100:2009 (Rev C) and ISO 9001:2008 certified. We maintain a staff of Reliability Engineering capable of performing Failure Analysis, Destructive Physical Analysis, Hermeticity Testing and Scanning Electron Microscopy. The manufacturing areas maintain two Class 100,000 Clean Rooms with Class 100 Laminar Flow Benches. Millipore (Small Particle Inspection) may be performed using an automated or manual process.



**LAMINAR FLOW BENCHES**

Environmental Test – Teledyne Relays maintains a full Environmental Test Lab on its premises. The Test Lab has the capabilities of performing a wide variety of vibration and shock testing. Also available are thermal test chambers for the performance temperature cycling and Thermal vacuum test. Radiographic Inspection (X-ray) both static and Real Time are available on all products. Particle Impact Noise Detection (PIND) is available on the TO-5 products.



**HERMETIC SEAL**



**AUTOMATED MILLIPORE CLEAN**



# Glossary

## Actuator

An actuator is the electromechanical mechanism that transfers the RF contacts from one position to another upon DC command.

## Arc Suppression Diode

A diode is connected in parallel with the coil. This diode limits the "reverse EMF spike" generated when the coil de-energizes to 0.7 volts. The diode cathode is connected to the positive side of the coil and the anode is connected to the negative side.

## Date Code

All switches are marked with either a unique serial number or a date code. Date codes are in accordance with MIL-STD-1285 Paragraph 5.2.5 and consist of four digits. The first two digits define the year and the last two digits define the week of the year (YYWW). Thus, 0532 identifies switches that passed through final inspection during the 32nd week of 2005.

## Latching

A latching switch remains in the selected position whether or not voltage is maintained. This can be accomplished with either a magnetic or mechanical latching mechanism.

## Indicator

Indicators tell the system which position the switch is in. Other names for indicators are telemetry contacts or tellback circuit. Indicators are usually a set of internally mounted DC contacts linked to the actuator. They can be wired to digital input lines, status lights, or interlocks. Unless otherwise specified, the maximum indicator contact rating is 30 Vdc, 50 mA, or 1.5 Watts into a resistive load.

## Isolation

Isolation is the measure of the power level at the output connector of an unconnected RF channel as referenced to the power at the input connector. It is specified in dB below the input power level.

## SPDT Switch

A single-pole double-throw switch has one input and two output ports.

## Switching Time

Switching time is the total interval beginning with the arrival of the leading edge of the command pulse at the switch DC input and ending with the completion of the switch transfer, including contact bounce. It consists of three parts: (1) inductive delay in the coil, (2) transfer time of the physical movement of the contacts, and (3) the bounce time of the RF contacts.

## Transfer Switch

A four-port switch consisting of two independent pairs of RF paths. These pairs are actuated simultaneously. This actuation is similar to that of a double-pole double-throw switch. See application notes for typical usage.

## Performance Parameters vs Frequency

Generally speaking, the RF performance of coaxial switches is frequency dependent. With increasing frequency, VSWR and insertion loss increase while isolation decreases. All data sheets specify these three parameters as "worst case" at the highest operating frequency. If the switch is to be used over a narrow frequency band, better performance can be achieved.

## Actuator Current vs Temperature

The resistance of the actuator coil varies as a function of temperature. There is an inverse relationship between the operating temperature of the switch and the actuator drive current. For switches operating at 28 VDC, the approximate actuator drive current at temperature, T, can be calculated using the equation:

$$I_T = \frac{I_A}{[1 + .00385 (T-20)]}$$

Where:

$I_T$  = Actuator current at temperature, T

$I_A$  = Room temperature actuator current – see data sheet

T = Temperature of interest in °C

## Magnetic Sensitivity

An electro-mechanical switch can be sensitive to ferrous materials and external magnetic fields. Neighboring ferrous materials should be permitted no closer than 0.5 inches and adjacent external magnetic fields should be limited to a flux density of less than 5 Gauss.

## Transfer Switch

The transfer switch is essentially a modified double-pole-double-throw (DPDT) device. However, a true DPDT switch is a six port device that contains two totally independent transmission paths. In a transfer switch two transmission paths are provided but they are not totally independent as illustrated in Figure 2.

## Examples of applications of the transfer switch are as follows:

### Two Transmitters to

Either of Two Antennas

Two microwave transmitters can be connected to either of two alternate antennas as shown in Figure 3.

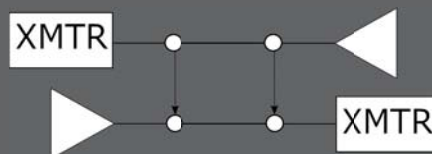

Figure 3

## Circuit Insertion

A complete microwave circuit or circuit element can be inserted into a transmission line by using a transfer switch as shown in Figure 4.

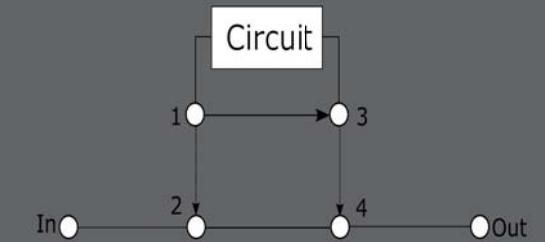
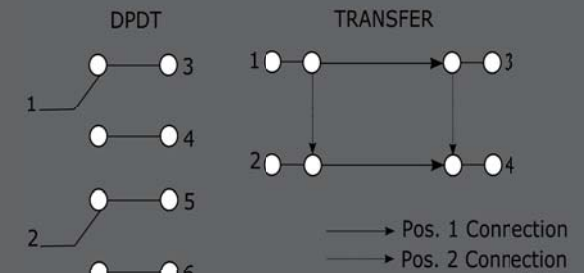

Figure 4

In the event that the 1-3 shorting of the microwave circuit is undesirable, this leg can be left out.



**Coil**

A wire assembly wound around an insulating bobbin or spool.

**Contact arrangement**

The combination of contacts that make up the entire relay switching structure.

**Contact bounce**

Internally caused intermittent and undesired opening of closed contacts, or closing of open contacts.

**Contact bounce time**

The interval between first make of the contact until the uncontrolled opening and closing of the contact ceases.

**Contact chatter**

The momentary opening of a closed contact due to external shock or vibration.

**Contact force**

The force exerted by a movable contact against its matching stationary contact when the contacts are closed.

**Contact gap**

The minimum distance between a moving contact and its matching stationary contact when the contacts are open.

**Contact Stabilization Time**

The interval between the first closure of a contact until the contacts reach and maintain a static contact resistance state.

**Contact weld**

The fusing of contacts, resulting in their failure to open. Contacts The current-carrying parts of a relay that open or close electrical circuits.

**Cycle, relay**

One opening and one closure of a contact set. One cycle consists of two operations.

**Dropout voltage, specified**

As the voltage on an energized relay is decreased, the voltage at or above which all relay contacts must return to their deenergized positions. Not applicable to latching relays.

**Electromechanical relay**

A relay in which the motion of the contacts are dependent upon the magnetic attraction or repulsion of an armature to or from a pole face. The magnetic force is generated by a coil which may or may not incorporate suppression and/or polarity reversal protection methods.

**Hermetically sealed relay**

A relay contained within an enclosure that is sealed by welding to insure a low rate of gas leakage.

**Inspection lot**

A grouping of relays based upon their similarity in manufacturing process characteristics and screening requirements submitted for inspection at one time.

**Latching (bistable) relay**

A two-position relay whose contacts transfer only as a result of coil energization of a particular coil, remain in that position with no coil energization, and transfer to the alternate position only as a result of coil energization of the other coil.

**Miss**

Failure to establish the intended contact conditions.

**Neutral position**

An anomalous state in latching (bistable) relays normally produced by insufficient coil signal or simultaneous pulsing of set and reset coils. Analogous to “don’t care” condition in electronic latches. This condition is not harmful to the relay.

**Normal mounting means**

A method of mounting whereby an intended test is performed on a relay and the fixture(s) employed adequately supports the relay and neither attenuates nor amplifies the intended condition.

**Normally closed contact**

Those contacts that are closed with the relay de-energized. Not applicable to latching relays.

**Normally open contact**

Those contacts that are open with the relay de-energized. Not applicable to latching relays.

**Operate time**

The interval between the application of an input signal and first closing of a normally open contact. Bounce time is not included.

**Operation, relay**

One opening or closure of a contact set. One relay operation is one-half of a cycle.

**Output**

The circuit within a relay which controls an external load circuit and is changed from a conducting to a non-conducting state (and vice versa) by the relay operation.

**Pickup voltage, specified**

As the current or voltage on a de-energized relay is increased, the voltage at or below which all contacts must achieve their energized positions.

**Polarized relay**

A relay, the operation of which is primarily dependent upon the direction (polarity) of the energizing current(s) and the resultant magnetic flux.

**Production lot**

A grouping of relays released for production as a single lot.

**Rated coil voltage**

The coil voltage at which the relay is designed to operate and meet all specified electrical, mechanical and environmental requirements.

**Relay**

An electrically controlled switch.

**Release time**

The interval between the removal of an input signal and first closing of a normally closed contact. Bounce time is not included. Not applicable to latching relays.

**Reset Voltage**

The voltage required to return the contacts of a latching relay from a set position to a specified initial condition. There is no universally defined reset position.

**Saturation**

The condition attained in a magnetic material when an increase in magnetizing (coil) current produces no appreciable increase in flux.

**Set Voltage**

The voltage required to change the contact position of a latching relay from a specified initial condition. There is no universally defined set position.

**Supply voltage**

The voltage source that supplies power to drive the relay coil.

# Did you know...

## Teledyne Relays offers electromechanical relays for various markets?

### RF RELAYS

- Signal Integrity up to 40Gbps
- DC - 16GHz
- Surface-Mount
- DPDT, SPDT, 4PST and Loopback Relays



### MILITARY GRADE RELAYS

- Built and tested to meet MIL-PRF-39016
- Built and tested to meet MIL-PRF-28776
- Built-in Diodes, Transistor Driver and CMOS
- Low Power coils

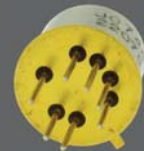
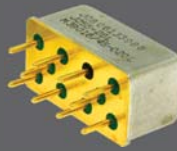

### TELEDYNE ESTABLISHED RELIABILITY RELAYS

- Fully defined product requirements and screening levels
- Spacer/Spreader pad options not allowed by military specifications
- Reduced lead time and cost vs Military Grade

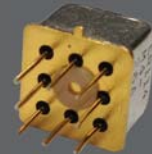
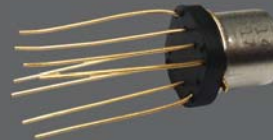

### HIGH PERFORMANCE RELAYS

- -65°C to +200°C
- Shock up to 4,000 g's
- Vibration up to 380 g's
- Non-Latching & Magnetic-Latching



### COMMERCIAL RELAYS

- Standard electrical tests at 25°C
- "Low cost" switching solutions
- Surface-Mount
- Short lead times



## Teledyne Coax Switches offers coaxial switches for ATE, Radar, Amplifier Switching, Etc.?

### SPDT SWITCHES

- DC - 40GHz, Internal 50Ω Termination
- SMA, mini-SMB, TNC & N Connectors
- 5 Million Cycles
- High Power & Low PIM
- Failsafe & Latching



### TRANSFER SWITCHES

- DC - 18GHz
- SMA, TNC & N Connectors
- 5 Million Cycles
- High Power
- Failsafe & Latching



### MULTI-THROW SWITCHES

- DC - 40GHz, Internal 50Ω Termination
- SMA, mini-SMB, TNC & N Connectors
- SP3T - SP10T
- 5 Million Cycles
- Normally Open & Latching



### 2P3T SWITCHES

- DC - 26.5GHz
- SMA Connectors
- 5 Million Cycles
- Failsafe & Latching

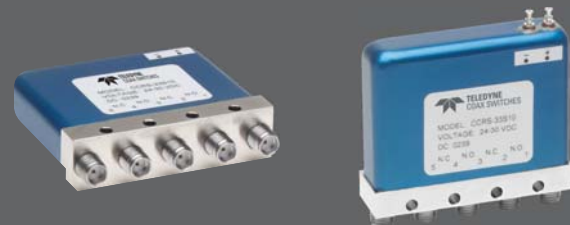

### SPECIALTY SWITCHES

- DC - 40GHz
- 3-State Attenuated Switch
- Radiation Shielding
- Switch Blocks
- Redundant Diode Configuration



# Did you know...

Teledyne Coax Switches offers coaxial switch matrices for ATE, Radar, Filter Switching, Airborne Surveillance Systems, Etc.?

## MINI MATRICES

- Remote Control via USB and/or Ethernet
- GUI controllable
- Accepts ASCII code
- Available in 18, 26.5 and 40 GHz
- SPDT, Transfer and Multi-throw configurations

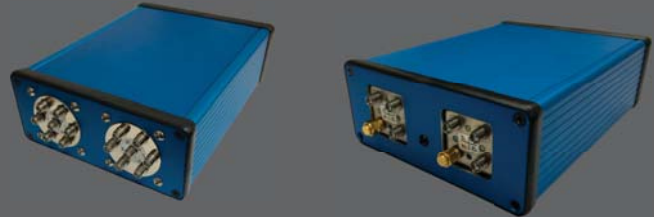

## MULTIPLEXOR/FANOUT SWITCH MATRICES

- Up to 1x1024 Switch Matrix
- SMA, mini-SMB, TNC & N Connectors
- Failsafe, Latching or Normally Open Configurations
- Switching Systems for 50  $\Omega$  & 75  $\Omega$  applications

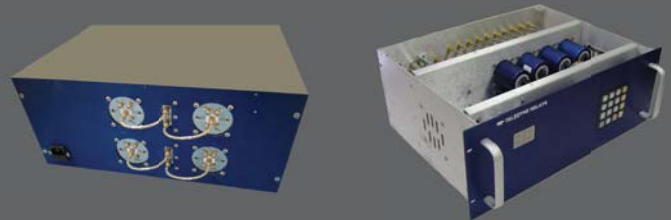

## MIMO/BLOCKING AND MIMO SINGLE CONNECTION SWITCH MATRICES

- Up to 1x1024 Switch Matrix
- SMA, mini-SMB, TNC & N Connectors
- RS-232, TTL, USB, GPIB, TTL, Ethernet Control
- 1 Million Cycles
- Failsafe & Latching

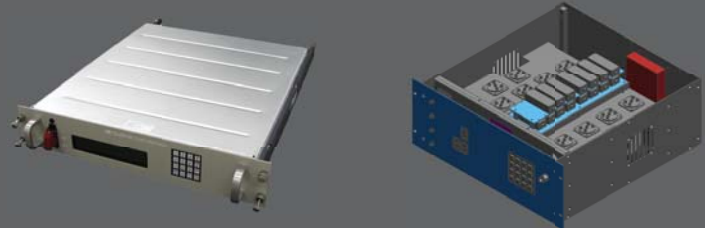

## CUSTOMIZED SWITCH MATRICES

- EMI/RFI
- Transient Suppression
- Ballistic Shock Fatigue
- Crash Load
- Altitude





## Teledyne Relays offers Commercial/Industrial Solid State Relays?

### SINGLE PHASE AC SOLID STATE RELAYS

- Up to 690Vac, 125A
- Input & Output Protection
- Chassis, DIN Rail and PCB Mount
- Zero-Cross & Random Switching
- Touch-Proof Covers



### DUAL-PHASE AC SOLID STATE RELAYS

- Up to 600Vac, 50A
- Output Protection
- Chassis and DIN Rail
- Zero-Cross & Random Switching
- Touch-Proof Covers



### 3 & 4 PHASE SOLID STATE RELAYS

- Up to 600Vac, 75A
- Output Protection
- Chassis and DIN Rail
- Zero-Cross & Random Switching
- DC & AC Control



### DC SOLID STATE RELAYS

- Up to 1400Vdc, 100A
- Output Protection
- Chassis, DIN Rail and PCB Mount
- IGBT and MOSFET
- Touch-Proof Covers



### SOFT START MOTOR CONTROLLERS AND MOTOR REVERSERS

- Up to 26kW, 480Vac
- Star & Delta Configurations
- DIN Rail
- Output Protection
- Built-in Diagnostics and Self Test





# Did you know...

## Teledyne Relays offers Military Solid State Relays?

### DC SOLID STATE RELAYS

- Meet MIL-PRF-28750
- Tested Per MIL-STD-704
- Up to 250Vdc, 10A
- Chassis and PCB Mount
- Short-Circuit Protection
- Plastic and Hermetically Sealed



### BI-DIRECTIONAL/AC SOLID STATE RELAYS

- Meet MIL-PRF-28750
- Tested Per MIL-STD-704
- Up to 250Vac, 25A
- Chassis and PCB Mount
- Short-Circuit Protection
- Plastic and Hermetically Sealed

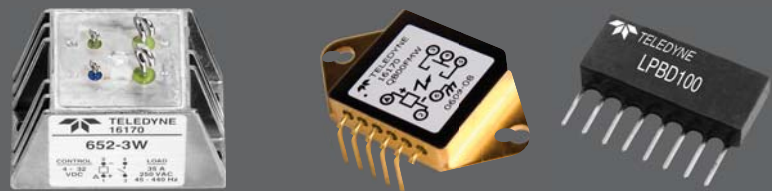

### NEW SILICON CARBIDE MOSFET SOLID STATE RELAY

- Up to 270Vdc, 20A
- Optical Isolation
- Meets 270Vdc requirements of MIL-STD-704
- Low ON Resistance



### COMMERCIAL, LOW POWER, I/O MODULES

- Up to 250Vac, 10A
- Short-Circuit Protection
- Chassis and PCB Mount
- Zero-Cross & Random Switching
- Low Off-State Leakage Current



### INPUT/OUTPUT MODULES

- Up to 250Vac, 1A
- Input Enable Function
- Low OFF-State Leakage
- Switches/Controls High Voltage and Current
- High dielectric strength

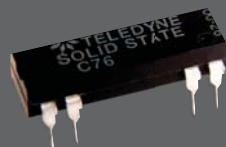



## Teledyne Relays Covers the RF Spectrum

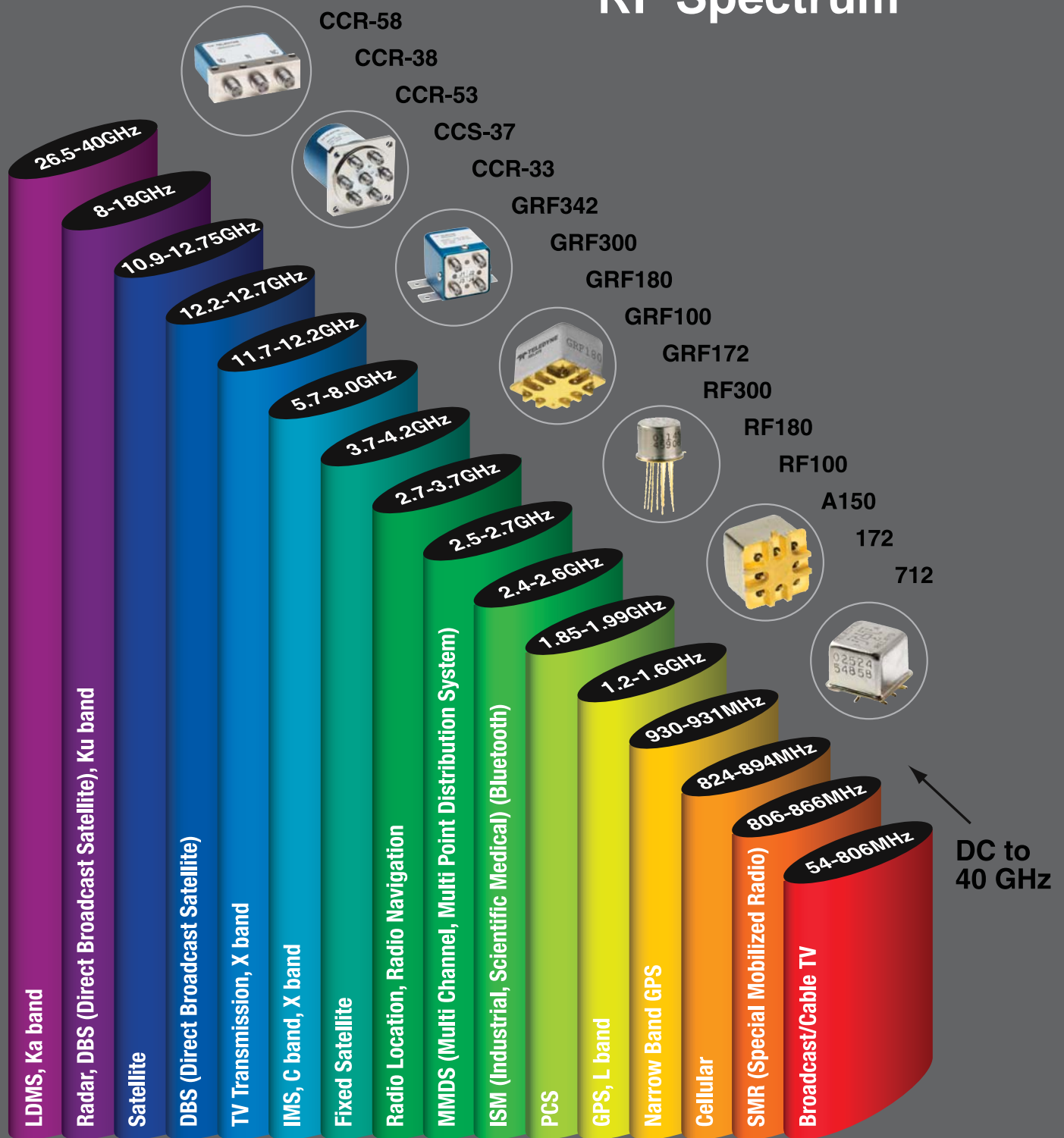

**HEADQUARTERS**  
12525 Daphne Ave.  
Hawthorne, CA 90250  
Phone: (323) 777-0077 or (800) 351-7368  
Fax: (323) 241-1287  
E-mail: [coax@teledyne.com](mailto:coax@teledyne.com)

[www.teledynecoax.com](http://www.teledynecoax.com)  
(800) 351-7368

**EUROPE**  
9-13 Napier Road  
Wardpark North  
Cumbernauld G68 OEF  
Scotland UK  
Phone: +44 (0) 1236 453 124  
Fax: +44 (0) 1236 780 651  
E-mail: [sales\\_europe@teledyne.com](mailto:sales_europe@teledyne.com)

[www.teledyne-europe.com](http://www.teledyne-europe.com)  
+44 (0) 1236 453 124

 **TELEDYNE**  
**RELAYS**  
Everywhereyoulook™

 **TELEDYNE**  
**COAX SWITCHES**  
Everywhereyoulook™