

PART NUMBER	DESCRIPTION
CCT-59S	Commercial Latching Multi-throw, DC-26.5GHz
CT-59S	Elite Latching Multi-throw, DC-26.5GHz

The CCT-59S/CT-59S is an Internally Terminated broadband, multi-throw, electromechanical coaxial switch designed to switch a microwave signal from a common input to any of 3, 4, 5, or 6 outputs. The characteristic impedance is 50 Ohms. Internal terminations provide an impedance match for the unselected ports. The switches are small using the popular connector spacing on a 1.062" dia. circle. Each position has an individual actuator mechanism allowing random position selection. This also minimizes switching time. The CCT-59S/CT-59S comes with a latching actuator. The latching switch remains in the last position selected when the switch is de-energized. STD dual command requires a reset pulse before a new selected position. A separate reset circuit allows all positions to be set to an open position. User must provide both reset (clear) and set (select new position) commands.



Available with USB & Ethernet Control!



ENVIRONMENTAL AND PHYSICAL CHARACTERISTICS	
Operating Temperature	
Commercial Model, CCT-59S	-25°C to 65°C
Elite Model, CT-59S	-55°C to 85°C
Vibration (MIL-STD-202 Method 214, Condition D, non-operating)	10 g's RMS
Shock (MIL-STD-202 Method 213, Condition D, non-operating)	500 g's
Standard Actuator Life	5,000,000 cycles
Actuator Life w/ Additional Features	1,000,000 cycles
Connector Type	SMA
Humidity (Moisture Seal)	Available
Weight	6 oz. (170.1g) (max.)

ELECTRICAL CHARACTERISTICS	
Form Factor	Multi-Throw, break before make
Frequency Range	
CCT-59S	DC-26.5 GHz
CT-59S	DC-26.5 GHz
Characteristic Impedance	50 Ohms
Operate Time	20 ms (max.)
Actuation Voltage Available	12 15 24 28 V
Actuation Current	255 205 130 90 mA
Reset Current (# of Positions)	3 765 615 390 270 mA
	4 1020 820 520 360 mA
	5 1275 1025 650 450 mA
	6 1530 1230 780 540 mA

TYPICAL PERFORMANCE CHARACTERISTICS							
Frequency	DC-3 GHz	3-6 GHz	6-12 GHz	12-18 GHz	18-20 GHz	20-22 GHz	22-26.5 GHz
Insertion Loss, dB, max.	0.2	0.2	0.4	0.5	0.6	0.6	0.8
Isolation, dB, min.	70	70	60	60	50	50	50
VSWR, max.	1.25:1	1.25:1	1.4:1	1.5:1	1.8:1	1.8:1	1.8:1

For maximum limits, please see charts on pages 6-8

PART NUMBERING SYSTEM

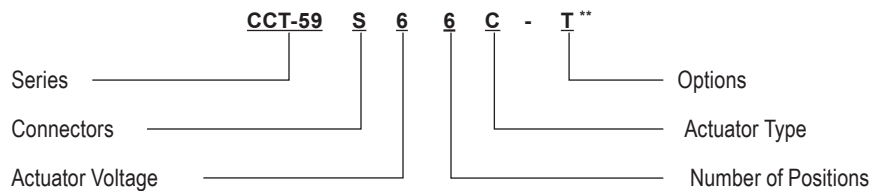

CONNECTOR	ACTUATOR VOLTAGE	NUMBER OF POSITIONS	ACTUATOR TYPE	OPTIONS
S: SMA FEMALE	6: 28 VDC LATCHING	3: SP3T	0: NO INDICATOR CONTACTS	T: TTL DRIVERS WITH DIODES
	7: 15 VDC LATCHING	4: SP4T	C: INDICATOR CONTACTS***	D: COIL TRANSIENT SUPPRESSION DIODES
	8: 12 VDC LATCHING	5: SP5T	D: SELF CUTOFF ONLY	R: POSITIVE + COMMON
	9: 24 VDC LATCHING	6: SP6T		TD: DECODERS AND TTL DRIVERS WITH DIODES
				M: MOISTURE SEAL
				S: D-SUB CONNECTOR*

** SEE PARTS LIST ON PAGE 11-13

***Indicator Contacts Operating Temperature -50°C to 85°C (Elite Model Only)

For additional options, please contact factory.

* D-Sub Connector may be 9 or 15 pin depending on number of throws. (See Connector Pinout page)

Series CCT-59S/CT-59S

Multi-Throw DC-26.5 GHz

Latching Coaxial Switch



SCHEMATICS AND MECHANICAL OUTLINE

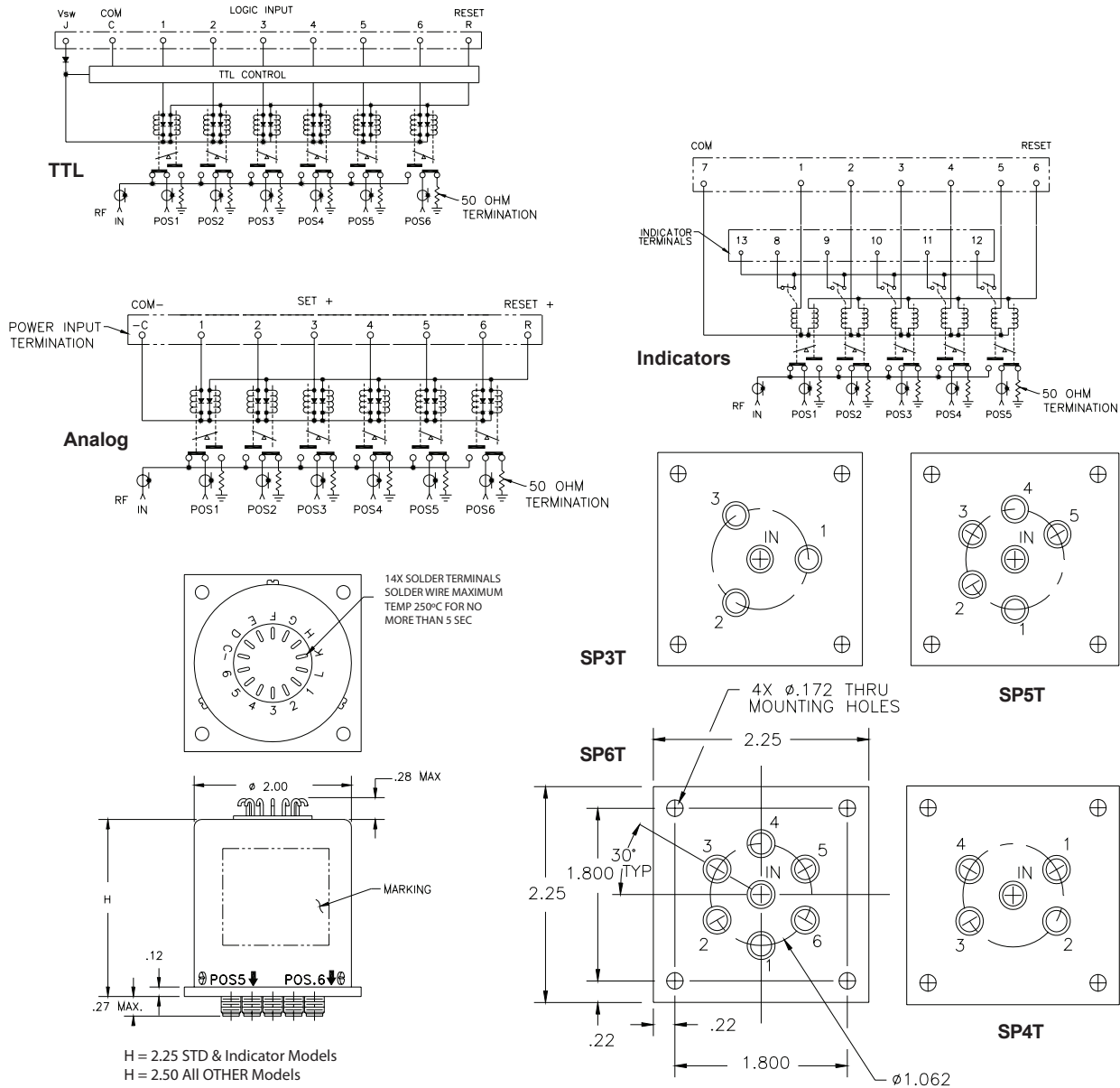

“-S OPTION” 9-PIN D-SUB OR 15-PIN D-MICRO CONNECTOR (EXAMPLE: CCT-59S660-S)

CONNECTOR PINOUT FOR LATCHING SP3T MULTI-THROW SWITCHES						
EXAMPLE	CT-59S130-S	CT-59S13C-S	CT-59S130-TS	CT-59S13C-TS	CT-59S130-TDS	CT-59S13C-TDS
PIN NO	2706650 9-PINS	2707572 15-PINS	2706650 9-PINS	2707572 15-PINS	2706650 9-PINS	2707572 15-PINS
INDICATOR		YES		YES		YES
TTL			YES	YES		
DECODERS & TTL					YES	YES
1	PORT 1	PORT 1	TTL 1	TTL 1	LOGIC 1	LOGIC 1
2	PORT 2	PORT 3	TTL 2	TTL 2	LOGIC 2	LOGIC 2
3	PORT 3	PORT 3	TTL 3	TTL 3	LOGIC 3	LOGIC 3
4						
5						
6						
7	COMMON	COMMON	COMMON	COMMON	COMMON	COMMON
8	RESET	RESET	RESET	RESET		
9		Vsw	Vsw	Vsw	Vsw	Vsw
10		D INDICATOR (COM)		D INDICATOR (COM)		D INDICATOR (COM)
11		E INDICATOR		E INDICATOR		E INDICATOR
12		F INDICATOR		F INDICATOR		F INDICATOR
13		G INDICATOR		G INDICATOR		G INDICATOR
14						
15						

CONNECTOR PINOUT FOR LATCHING SP4T MULTI-THROW SWITCHES						
EXAMPLE	CT-59S140-S	CT-59S14C-S	CT-59S140-TS	CT-59S14C-TS	CT-59S140-TDS	CT-59S14C-TDS
PIN NO	2706650 9-PINS	2707572 15-PINS	2706650 9-PINS	2707572 15-PINS	2706650 9-PINS	2707572 15-PINS
INDICATOR		YES		YES		YES
TTL			YES	YES		
DECODERS & TTL					YES	YES
1	PORT 1	PORT 1	TTL 1	TTL 1	LOGIC 1	LOGIC 1
2	PORT 2	PORT 3	TTL 2	TTL 2	LOGIC 2	LOGIC 2
3	PORT 3	PORT 3	TTL 3	TTL 3	LOGIC 3	LOGIC 3
4	PORT 4	PORT 4	TTL 4	TTL 4		
5						
6						
7	COMMON	COMMON	COMMON	COMMON	COMMON	COMMON
8	RESET	RESET	RESET	RESET		
9			Vsw	Vsw	Vsw	Vsw
10		D INDICATOR (COM)		D INDICATOR (COM)		D INDICATOR (COM)
11		E INDICATOR		E INDICATOR		E INDICATOR
12		F INDICATOR		F INDICATOR		F INDICATOR
13		G INDICATOR		G INDICATOR		G INDICATOR
14		H INDICATOR		H INDICATOR		H INDICATOR
15						

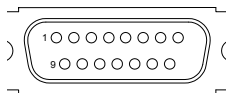

9-PIN D-SUB CONNECTOR

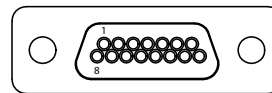

15-PIN D-MICRO CONNECTOR

Series CCT-59S/CT-59S
Multi-Throw DC-26.5 GHz
Latching Coaxial Switch



CONNECTOR PINOUT FOR LATCHING SP5T MULTI-THROW SWITCHES						
EXAMPLE	CT-59S150-S	CT-59S15C-S	CT-59S150-TS	CT-59S15C-TS	CT-59S150-TDS	CT-59S15C-TDS
PIN NO	2706650 9-PINS	2707572 15-PINS	2706650 9-PINS	2707572 15-PINS	2706650 9-PINS	2707572 15-PINS
INDICATOR		YES		YES		YES
TTL			YES	YES		
DECODERS & TTL					YES	YES
1	PORT 1	PORT 1	TTL 1	TTL 1	LOGIC 1	LOGIC 1
2	PORT 2	PORT 3	TTL 2	TTL 2	LOGIC 2	LOGIC 2
3	PORT 3	PORT 3	TTL 3	TTL 3	LOGIC 3	LOGIC 3
4	PORT 4	PORT 4	TTL 4	TTL 4		
5	PORT 5	PORT 5	TTL 5	TTL 5		
6						
7	COMMON	COMMON	COMMON	COMMON	COMMON	COMMON
8	RESET	RESET	RESET	RESET		
9			Vsw	Vsw	Vsw	Vsw
10		D INDICATOR (COM)		D INDICATOR (COM)		D INDICATOR (COM)
11		E INDICATOR		E INDICATOR		E INDICATOR
12		F INDICATOR		F INDICATOR		F INDICATOR
13		G INDICATOR		G INDICATOR		G INDICATOR
14		H INDICATOR		H INDICATOR		H INDICATOR
15		K INDICATOR		K INDICATOR		K INDICATOR

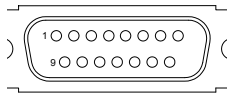

9-PIN D-SUB CONNECTOR

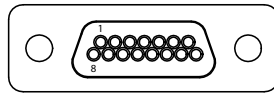

15-PIN D-MICRO CONNECTOR

CONNECTOR PINOUT FOR LATCHING SP6T MULTI-THROW SWITCHES						
EXAMPLE	CR-59S160-S	CR-59S16C-S	CR-59S160-TS	CR-59S16C-TS	CR-59S160-TDS	CR-59S16C-TDS
PIN NO	2706650 9-PINS	2707572 15-PINS	2706650 9-PINS	C00-166-1 26-PINS	2706650 9-PINS	2707572 15-PINS
INDICATOR		YES		YES		YES
TTL			YES	YES		
DECODERS & TTL					YES	YES
1	PORT 1	PORT 1	TTL 1	TTL 1	LOGIC 1	LOGIC 1
2	PORT 2	PORT 3	TTL 2	TTL 2	LOGIC 2	LOGIC 2
3	PORT 3	PORT 3	TTL 3	TTL 3	LOGIC 3	LOGIC 3
4	PORT 4	PORT 4	TTL 4	TTL 4		
5	PORT 5	PORT 5	TTL 5	TTL 5		
6	PORT 6	PORT 6	TTL 6	TTL 6		
7	COMMON	COMMON	COMMON	COMMON	COMMON	COMMON
8	RESET	RESET	RESET	RESET		
9		D INDICATOR (COM)	Vsw	Vsw	Vsw	D INDICATOR (COM)
10		E INDICATOR				E INDICATOR
11		F INDICATOR				F INDICATOR
12		G INDICATOR				G INDICATOR
13		H INDICATOR				H INDICATOR
14		K INDICATOR				K INDICATOR
15		L INDICATOR		D INDICATOR (COM)		L INDICATOR
16				E INDICATOR		
17				F INDICATOR		
18				G INDICATOR		
19				H INDICATOR		
20				K INDICATOR		
21				L INDICATOR		
22						
23						
24						
25						
26						

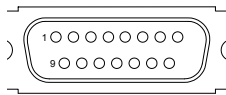

9-PIN D-SUB CONNECTOR

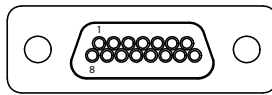

15-PIN D-MICRO CONNECTOR

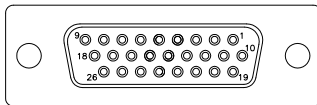

26-PIN D-SUB CONNECTOR

Series CCT-59S/CT-59S
Multi-Throw DC-26.5 GHz
Latching Coaxial Switch



CONNECTOR PINOUT FOR LATCHING SP7T MULTI-THROW SWITCHES						
EXAMPLE	CT-59S170-S	CT-59S17C-S	CT-59S170-TS	CT-59S17C-TS	CT-59S170-TDS	CT-59S17C-TDS
PIN NO	2707572 15-PINS	25-PINS	2707572 15-PINS	25-PINS	2707572 15-PINS	25-PINS
INDICATOR		YES		YES		YES
TTL			YES	YES		
DECODERS & TTL					YES	YES
1	PORT 1	PORT 1	TTL 1	TTL 1	LOGIC 1	LOGIC 1
2	PORT 2	PORT 3	TTL 2	TTL 2	LOGIC 2	LOGIC 2
3	PORT 3	PORT 3	TTL 3	TTL 3	LOGIC 3	LOGIC 3
4	PORT 4	PORT 4	TTL 4	TTL 4		
5	PORT 5	PORT 5	TTL 5	TTL 5		
6	PORT 6	PORT 6	TTL 6	TTL 6		
7	PORT 7	PORT 7	TTL 7	TTL 7		
8						
9						
10						
11			Vsw	Vsw	Vsw	Vsw
12	RESET	RESET	RESET	RESET		
13	COMMON	COMMON	COMMON	COMMON	COMMON	COMMON
14						
15		D INDICATOR (COM)		D INDICATOR (COM)		D INDICATOR (COM)
16		E INDICATOR		E INDICATOR		E INDICATOR
17		F INDICATOR		F INDICATOR		F INDICATOR
18		G INDICATOR		G INDICATOR		G INDICATOR
19		H INDICATOR		H INDICATOR		H INDICATOR
20		K INDICATOR		K INDICATOR		K INDICATOR
21		L INDICATOR		L INDICATOR		L INDICATOR
22		M INDICATOR		M INDICATOR		M INDICATOR
23						
24						
25						

CONNECTOR PINOUT FOR LATCHING SP8T MULTI-THROW SWITCHES						
EXAMPLE	CT-59S180-S	CT-59S18C-S	CT-59S180-TS	CT-59S18C-TS	CT-59S180-TDS	CT-59S18C-TDS
PIN NO	2707572 15-PINS	25-PINS	2707572 15-PINS	25-PINS	2707572 15-PINS	25-PINS
INDICATOR		YES		YES		YES
TTL			YES	YES		
DECODERS & TTL					YES	YES
1	PORT 1	PORT 1	TTL 1	TTL 1	LOGIC 1	LOGIC 1
2	PORT 2	PORT 3	TTL 2	TTL 2	LOGIC 2	LOGIC 2
3	PORT 3	PORT 3	TTL 3	TTL 3	LOGIC 3	LOGIC 3
4	PORT 4	PORT 4	TTL 4	TTL 4	LOGIC 4	LOGIC 4
5	PORT 5	PORT 5	TTL 5	TTL 5		
6	PORT 6	PORT 6	TTL 6	TTL 6		
7	PORT 7	PORT 7	TTL 7	TTL 7		
8	PORT 8	PORT 8	TTL 8	TTL 8		
9						
10						
11			Vsw	Vsw	Vsw	Vsw
12	RESET	RESET	RESET	RESET		
13	COMMON	COMMON	COMMON	COMMON	COMMON	COMMON
14						
15		D INDICATOR (COM)		D INDICATOR (COM)		D INDICATOR (COM)
16		E INDICATOR		E INDICATOR		E INDICATOR
17		F INDICATOR		F INDICATOR		F INDICATOR
18		G INDICATOR		G INDICATOR		G INDICATOR
19		H INDICATOR		H INDICATOR		H INDICATOR
20		K INDICATOR		K INDICATOR		K INDICATOR
21		L INDICATOR		L INDICATOR		L INDICATOR
22		M INDICATOR		M INDICATOR		M INDICATOR
23		N INDICATOR		N INDICATOR		N INDICATOR
24						
25						

Series CCT-59S/CT-59S
Multi-Throw DC-26.5 GHz
Latching Coaxial Switch



CONNECTOR PINOUT FOR LATCHING SP9T MULTI-THROW SWITCHES						
EXAMPLE	CT-59S190-S	CT-59S19C-S	CT-59S190-TS	CT-59S19C-TS	CT-59S190-TDS	CT-59S19C-TDS
PIN NO	2707572 15-PINS	25-PINS	2707572 15-PINS	25-PINS	2707572 15-PINS	25-PINS
INDICATOR		YES		YES		YES
TTL			YES	YES		
DECODERS & TTL					YES	YES
1	PORT 1	PORT 1	TTL 1	TTL 1	LOGIC 1	LOGIC 1
2	PORT 2	PORT 3	TTL 2	TTL 2	LOGIC 2	LOGIC 2
3	PORT 3	PORT 3	TTL 3	TTL 3	LOGIC 3	LOGIC 3
4	PORT 4	PORT 4	TTL 4	TTL 4	LOGIC 4	LOGIC 4
5	PORT 5	PORT 5	TTL 5	TTL 5		
6	PORT 6	PORT 6	TTL 6	TTL 6		
7	PORT 7	PORT 7	TTL 7	TTL 7		
8	PORT 8	PORT 8	TTL 8	TTL 8		
9	PORT 9	PORT 9	TTL 9	TTL 9		
10						
11			Vsw	Vsw	Vsw	Vsw
12	RESET	RESET	RESET	RESET		
13	COMMON	COMMON	COMMON	COMMON	COMMON	COMMON
14						
15		D INDICATOR (COM)		D INDICATOR (COM)		D INDICATOR (COM)
16		E INDICATOR		E INDICATOR		E INDICATOR
17		F INDICATOR		F INDICATOR		F INDICATOR
18		G INDICATOR		G INDICATOR		G INDICATOR
19		H INDICATOR		H INDICATOR		H INDICATOR
20		K INDICATOR		K INDICATOR		K INDICATOR
21		L INDICATOR		L INDICATOR		L INDICATOR
22		M INDICATOR		M INDICATOR		M INDICATOR
23		N INDICATOR		N INDICATOR		N INDICATOR
24		P INDICATOR		P INDICATOR		P INDICATOR
25						

CONNECTOR PINOUT FOR LATCHING SP10T MULTI-THROW SWITCHES						
EXAMPLE	CT-59S100-S	CT-59S10C-S	CT-59S100-TS	CT-59S10C-TS	CT-59S100-TDS	CT-59S10C-TDS
PIN NO	2707572 15-PINS	25-PINS	2707572 15-PINS	25-PINS	2707572 15-PINS	25-PINS
INDICATOR		YES		YES		YES
TTL			YES	YES		
DECODERS & TTL					YES	YES
1	PORT 1	PORT 1	TTL 1	TTL 1	LOGIC 1	LOGIC 1
2	PORT 2	PORT 3	TTL 2	TTL 2	LOGIC 2	LOGIC 2
3	PORT 3	PORT 3	TTL 3	TTL 3	LOGIC 3	LOGIC 3
4	PORT 4	PORT 4	TTL 4	TTL 4	LOGIC 4	LOGIC 4
5	PORT 5	PORT 5	TTL 5	TTL 5		
6	PORT 6	PORT 6	TTL 6	TTL 6		
7	PORT 7	PORT 7	TTL 7	TTL 7		
8	PORT 8	PORT 8	TTL 8	TTL 8		
9	PORT 9	PORT 9	TTL 9	TTL 9		
10	PORT 10	PORT 10	TTL 10	TTL 10		
11			Vsw	Vsw	Vsw	Vsw
12	RESET	RESET	RESET	RESET		
13	COMMON	COMMON	COMMON	COMMON	COMMON	COMMON
14						
15		D INDICATOR (COM)		D INDICATOR (COM)		D INDICATOR (COM)
16		E INDICATOR		E INDICATOR		E INDICATOR
17		F INDICATOR		F INDICATOR		F INDICATOR
18		G INDICATOR		G INDICATOR		G INDICATOR
19		H INDICATOR		H INDICATOR		H INDICATOR
20		K INDICATOR		K INDICATOR		K INDICATOR
21		L INDICATOR		L INDICATOR		L INDICATOR
22		M INDICATOR		M INDICATOR		M INDICATOR
23		N INDICATOR		N INDICATOR		N INDICATOR
24		P INDICATOR		P INDICATOR		P INDICATOR
25		T INDICATOR		T INDICATOR		T INDICATOR

Series CCT-59S/CT-59S

Multi-Throw DC-26.5 GHz
Latching Coaxial Switch



TRUTH TABLE Latching CCT-59SX3C-T

Logic Input				RF Path				Indicator Switches		
1	2	3	R	J1	J2	J3	Reset	E	F	G
1	0	0	0	On	Off	Off	Off	C	0	0
0	1	0	0	Off	On	Off	Off	0	C	0
0	0	1	0	Off	Off	On	Off	0	0	C

TRUTH TABLE Latching CCT-59SX3C-TD

Logic Input			RF Path				Indicator Switches		
1	2	3	J1	J2	J3	Reset	E	F	G
0	0	0	On	Off	Off	Off	C	0	0
1	0	0	Off	On	Off	Off	0	C	0
0	1	0	Off	Off	On	Off	0	0	C
0	1	1	Off	Off	Off	Reset	0	0	0
1	1	1	COIL OFF				0	0	0

TRUTH TABLE Latching CCT-59SX4C-T

Logic Input					RF Path					Indicator Switches			
1	2	3	4	R	J1	J2	J3	J4	Reset	E	F	G	H
1	0	0	0	0	On	Off	Off	Off	Off	C	0	0	0
0	1	0	0	0	Off	On	Off	Off	Off	0	C	0	0
0	0	1	0	0	Off	Off	On	Off	Off	0	0	C	0
0	0	0	1	0	Off	Off	Off	On	Off	0	0	0	C

TRUTH TABLE Latching CCT-59SX4C-TD

Logic Input			RF Path					Indicator Switches			
1	2	3	J1	J2	J3	J4	Reset	E	F	G	H
0	0	0	On	Off	Off	Off	Off	C	0	0	0
1	0	0	Off	On	Off	Off	Off	0	C	0	0
0	1	0	Off	Off	On	Off	Off	0	0	C	0
1	1	0	Off	Off	Off	On	Off	0	0	0	C
0	1	1	Off	Off	Off	Off	Reset	0	0	0	0
1	1	1	COIL OFF					0	0	0	0

TRUTH TABLE Latching
CCT-59SX5C-T

Logic Input						RF Path						Indicator Switches				
1	2	3	4	5	R	J1	J2	J3	J4	J5	Reset	E	F	G	H	K
1	0	0	0	0	0	On	Off	Off	Off	Off	Off	C	0	0	0	0
0	1	0	0	0	0	Off	On	Off	Off	Off	Off	0	C	0	0	0
0	0	1	0	0	0	Off	Off	On	Off	Off	Off	0	0	C	0	0
0	0	0	1	0	0	Off	Off	Off	On	Off	Off	0	0	0	C	0
0	0	0	0	1	0	Off	Off	Off	Off	On	Off	0	0	0	0	C

TRUTH TABLE Latching
CCT-59SX5C-TD

Logic Input			RF Path					Indicator Switches					
1	2	3	J1	J2	J3	J4	J5	Reset	E	F	G	H	K
0	0	0	On	Off	Off	Off	Off	Off	C	0	0	0	0
1	0	0	Off	On	Off	Off	Off	Off	0	C	0	0	0
0	1	0	Off	Off	On	Off	Off	Off	0	0	C	0	0
1	1	0	Off	Off	Off	On	Off	Off	0	0	0	C	0
0	0	1	Off	Off	Off	Off	On	Off	0	0	0	0	C
0	1	1	Off	Off	Off	Off	Off	Reset	0	0	0	0	0
1	1	1	COIL OFF						0	0	0	0	0

TRUTH TABLE Latching
CCT-59SX6C-T

Logic Input							RF Path							Indicator Switches					
1	2	3	4	5	6	R	J1	J2	J3	J4	J5	J6	Reset	E	F	G	H	K	L
1	0	0	0	0	0	0	On	Off	Off	Off	Off	Off	Off	C	0	0	0	0	0
0	1	0	0	0	0	0	Off	On	Off	Off	Off	Off	Off	0	C	0	0	0	0
0	0	1	0	0	0	0	Off	Off	On	Off	Off	Off	Off	0	0	C	0	0	0
0	0	0	1	0	0	0	Off	Off	Off	On	Off	Off	Off	0	0	0	C	0	0
0	0	0	0	1	0	0	Off	Off	Off	Off	On	Off	Off	0	0	0	0	C	0
0	0	0	0	0	1	0	Off	Off	Off	Off	Off	On	Off	0	0	0	0	0	C

TRUTH TABLE Latching
CCT-59SX6C-TD

Logic Input			RF Path						Indicator Switches						
1	2	3	J1	J2	J3	J4	J5	J6	Reset	E	F	G	H	K	L
0	0	0	On	Off	Off	Off	Off	Off	Off	C	0	0	0	0	0
1	0	0	Off	On	Off	Off	Off	Off	Off	0	C	0	0	0	0
0	1	0	Off	Off	On	Off	Off	Off	Off	0	0	C	0	0	0
1	1	0	Off	Off	Off	On	Off	Off	Off	0	0	0	C	0	0
0	0	1	Off	Off	Off	Off	On	Off	Off	0	0	0	0	C	0
1	0	1	Off	Off	Off	Off	Off	On	Off	0	0	0	0	0	C
0	1	1	Off	Off	Off	Off	Off	Off	Reset	0	0	0	0	0	0
1	1	1	COIL OFF							0	0	0	0	0	0

TYPICAL NARROWBAND RF INSERTION LOSS PERFORMANCE CURVES

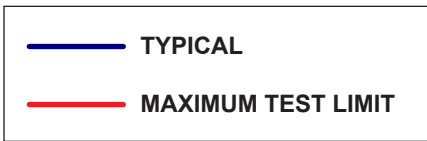
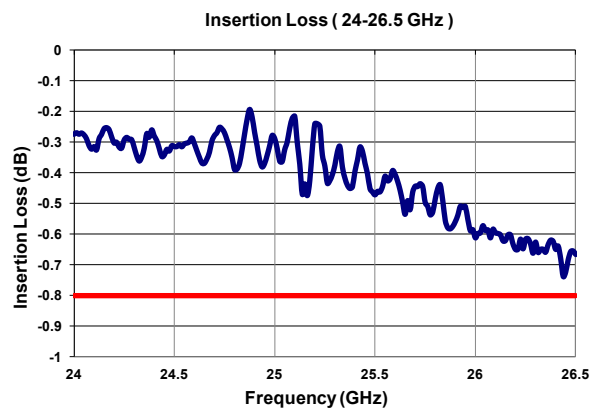
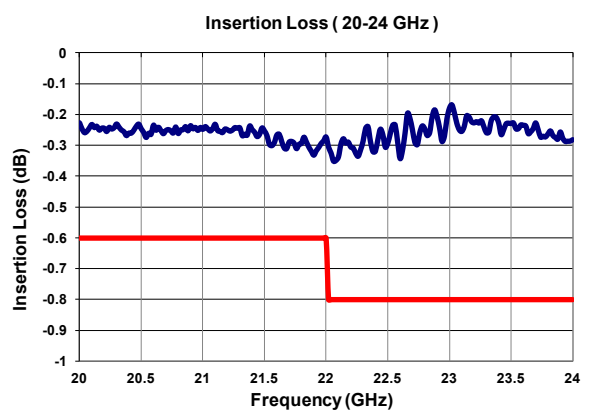
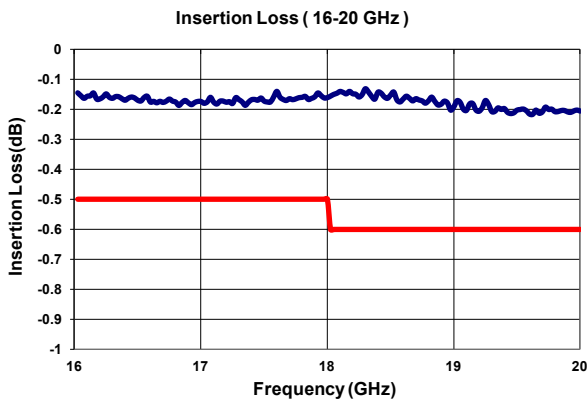
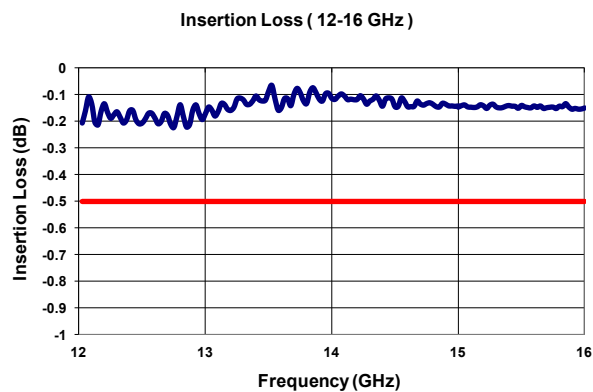
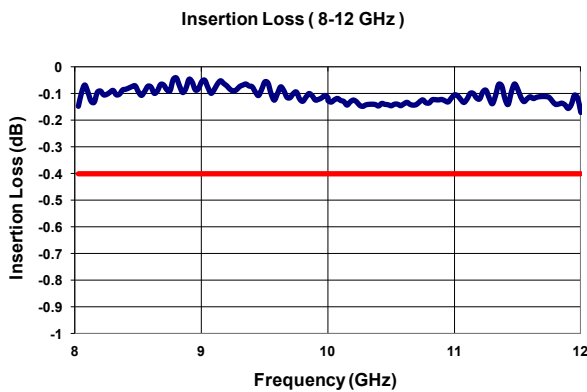
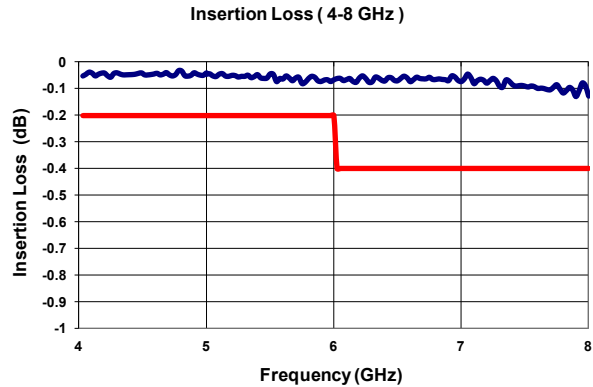
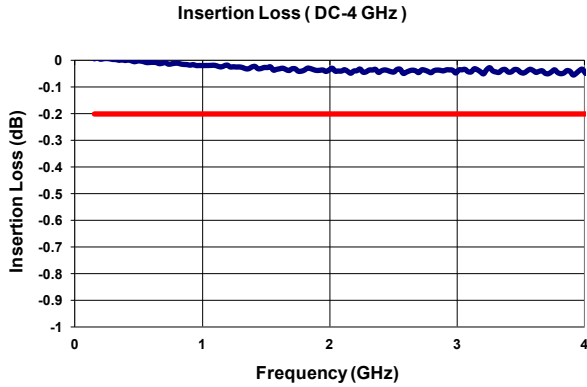

TYPICAL NARROWBAND RF ISOLATION PERFORMANCE CURVES

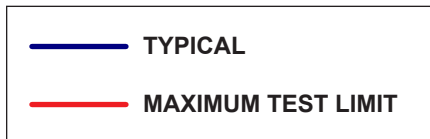
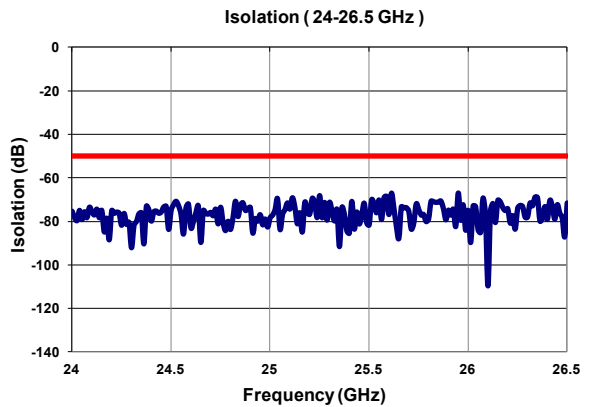
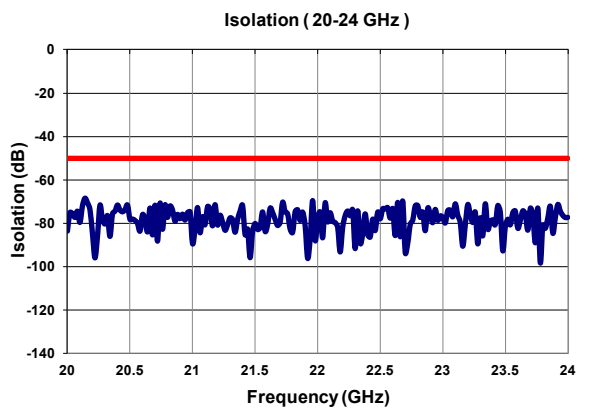
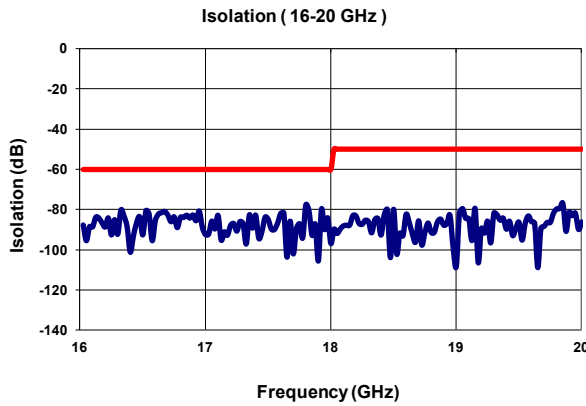
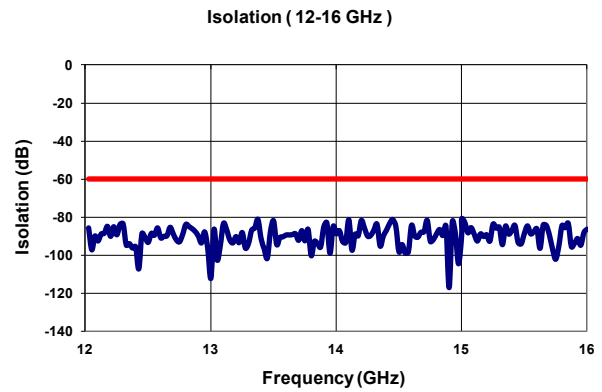
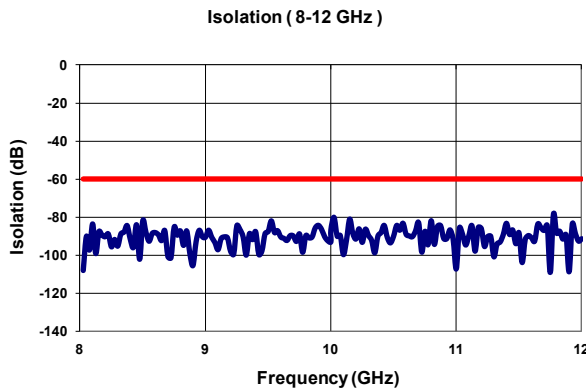
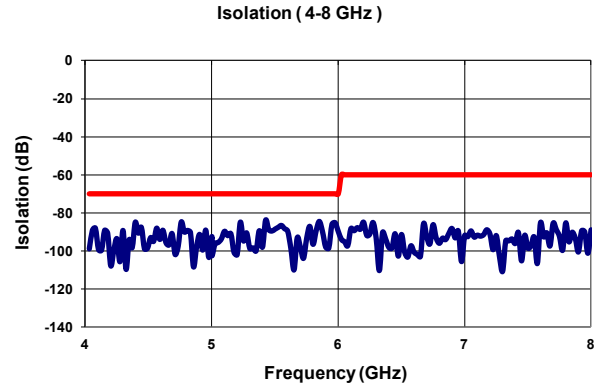
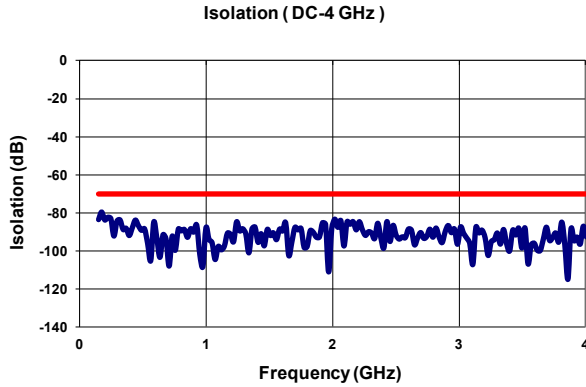

TYPICAL NARROWBAND RF VSWR PERFORMANCE CURVES

VSWR (DC-4 GHz)

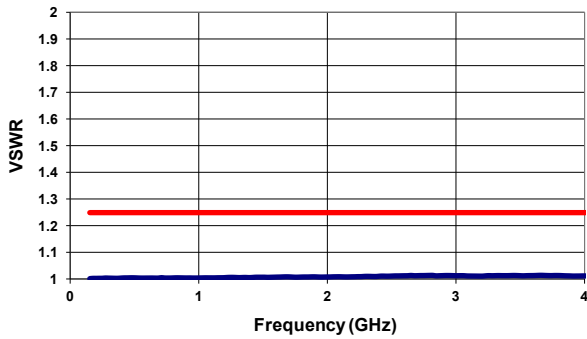

VSWR (4-8 GHz)

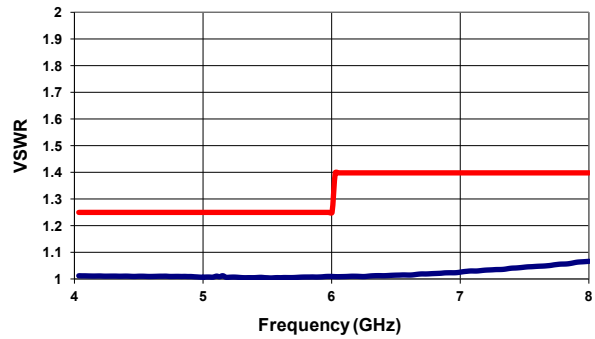

VSWR (8-12 GHz)

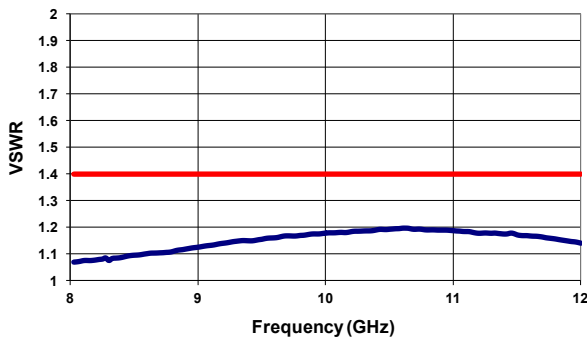

VSWR (12-16 GHz)

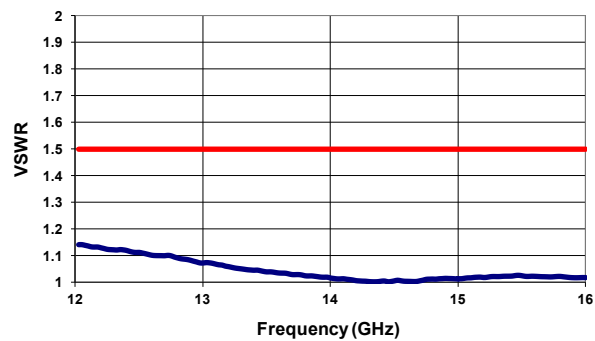

VSWR (16-20 GHz)

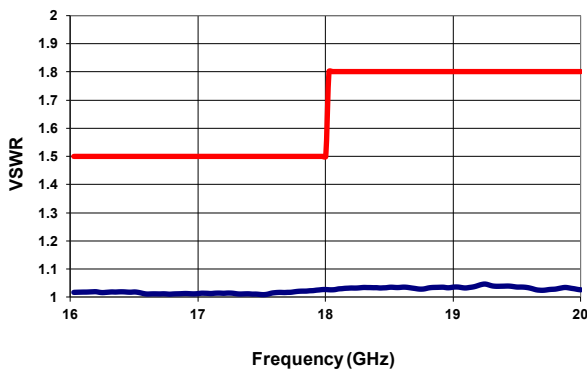

VSWR (20-24 GHz)

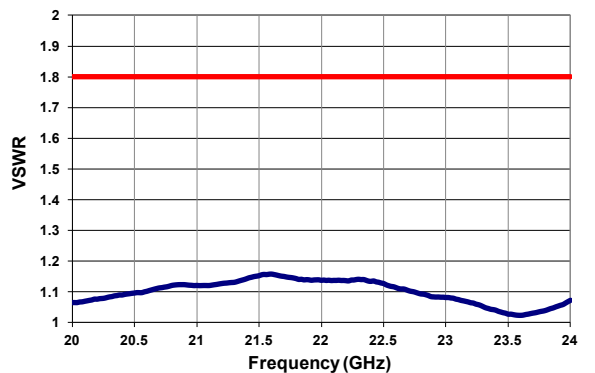

VSWR (24-26.5 GHz)

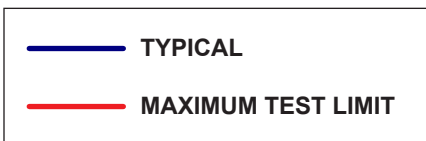
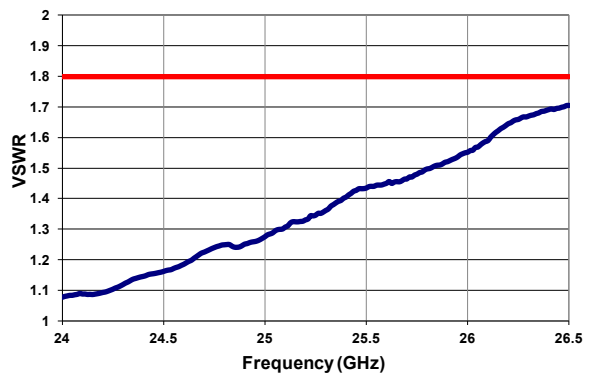

TYPICAL POWER PERFORMANCE CURVE

Power Handling vs. Frequency

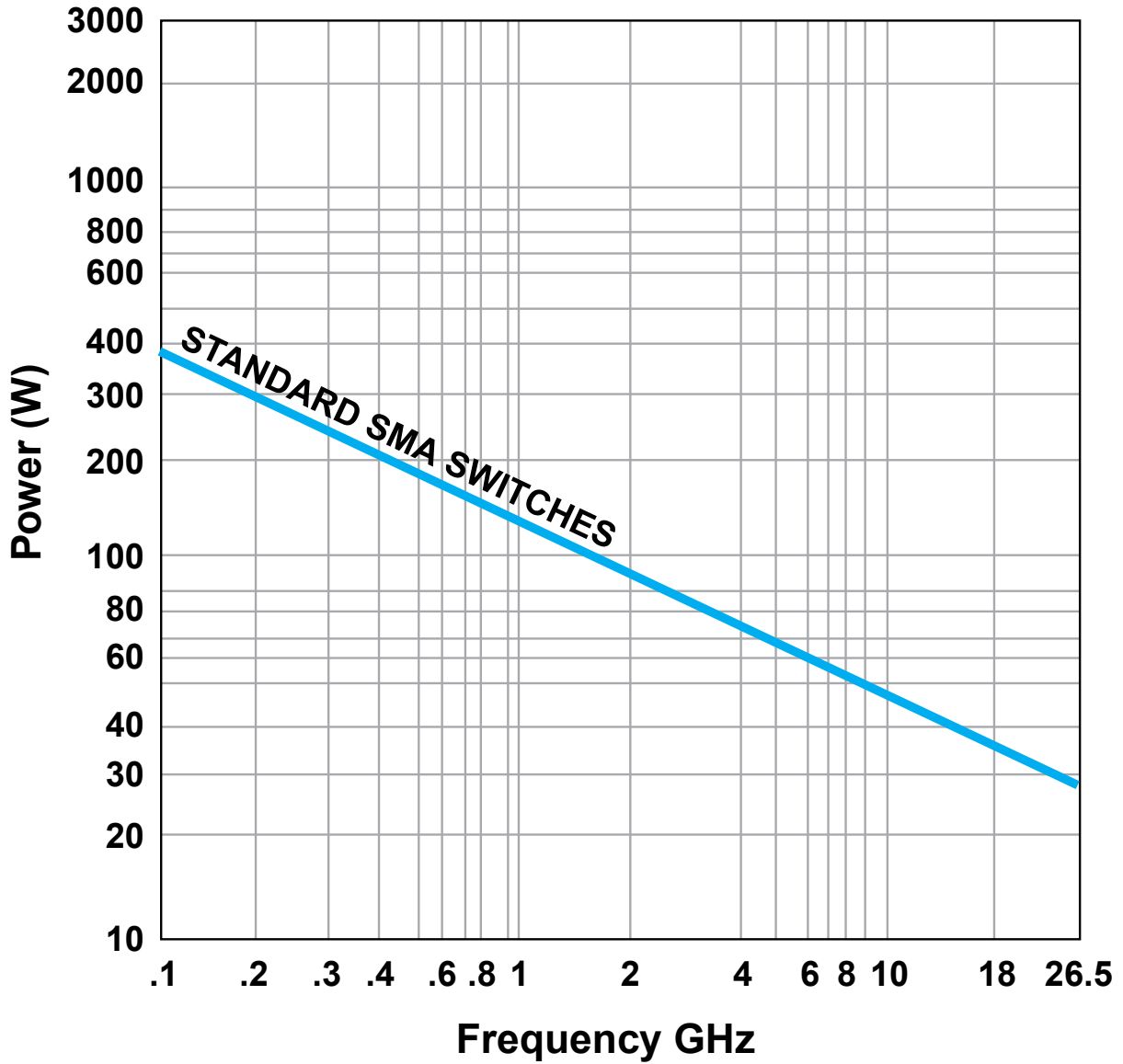

Estimates based on the following reference conditions:

- Ambient temperature of 40°C or less
- Sea level operation
- Load VSWR of 1.20:1 maximum
- No high-power (hot) switching

Please contact Teledyne Coax Switches for derating factors when applications do not meet the foregoing reference conditions.

GLOSSARY

Actuator

An actuator is the electromechanical mechanism that transfers the RF contacts from one position to another upon DC command.

Arc Suppression Diode

A diode is connected in parallel with the coil. This diode limits the "reverse EMF spike" generated when the coil de-energizes to 0.7 volts. The diode cathode is connected to the positive side of the coil and the anode is connected to the negative side.

Date Code

All switches are marked with either a unique serial number or a date code. Date codes are in accordance with MIL-STD-1285 Paragraph 5.2.5 and consist of four digits. The first two digits define the year and the last two digits define the week of the year (YYWW). Thus, 1032 identifies switches that passed through final inspection during the 32nd week of 2010.

Indicator

Indicators tell the system which position the switch is in. Other names for indicators are telemetry contacts or tellback circuit. Indicators are usually a set of internally mounted DC contacts linked to the actuator. They can be wired to digital input lines, status lights, or interlocks. Unless otherwise specified, the maximum indicator contact rating is 30 Vdc, 50 mA, or 1.5 Watts into a resistive load.

Isolation

Isolation is the measure of the power level at the output connector of an unconnected RF channel as referenced to the power at the input connector. It is specified in dB below the input power level.

Multi-Throw Latching Switch

A multi-throw switch is a switch with one input and three or more output ports. The CCT-59 can switch a microwave signal to any of 2,3,4,5 or 6 output from a single common input.

- DUAL PULSE SWITCHING COMMAND CHARACTERISTICS:
1. APPLIES FOR SINGLE-POLE MULTI-THROW LATCHING SWITCH ONLY.
 2. MUST APPLY RESET PULSE FIRST (BREAK-BEFORE-MAKE).
 3. RESET AND SET DEFINITIONS:
 RESET: OPEN ALL RF PATHS (POSITIONS).
 SET: CLOSE THE SELECTED RF PATH (POSITION).
 4. COMMAND PULSE TIMING:

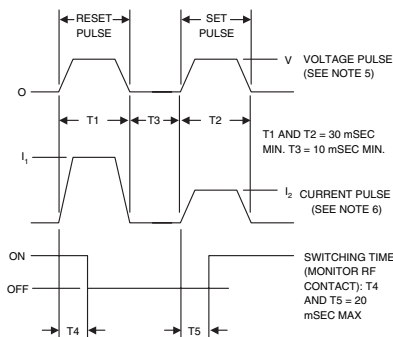

5. COMMAND SWITCHING VOLTAGE:
V = 26-32 VDC PULSE
6. SWITCHING CURRENT:

SWITCHING CURRENT AT 28 VDC AND 20°C		
NO. OF POS.	RESET (I ₁)	SET (I ₂)
3 POS.	270 mA	90 mA
4 POS.	360 mA	90 mA
5 POS.	450 mA	90 mA
6 POS.	540 mA	90 mA

Switching Time

Switching time is the total interval beginning with the arrival of the leading edge of the command pulse at the switch DC input and ending with the completion of the switch transfer, including contact bounce. It consists of three parts: (1) inductive delay in the coil, (2) transfer time of the physical movement of the contacts, and (3) the bounce time of the RF contacts.

TTL Switch Driver Option

As a special option, switch drivers can be provided for both failsafe and latching switches, which are compatible with industry-standard low-power Schottky TTL circuits.

TD-Option

This option includes a decoder. The 3-bit parallel command is decoded to internally select the appropriate position. See the logic tables. The TD-Option increases the V_{sw} supply current demand by 50mA max at 28Vdc and +20°C.

Performance Parameters vs Frequency

Generally speaking, the RF performance of coaxial switches is frequency dependent. With increasing frequency, VSWR and insertion loss increase while isolation decreases. All data sheets specify these three parameters as "worst case" at the highest operating frequency. If the switch is to be used over a narrow frequency band, better performance can be achieved.

Actuator Current vs Temperature

The resistance of the actuator coil varies as a function of temperature. There is an inverse relationship between the operating temperature of the switch and the actuator drive current. For switches operating at 28 VDC, the approximate actuator drive current at temperature, T, can be calculated using the equation:

$$I_T = \frac{I_A}{[1 + .00385 (T-20)]}$$

Where:

I_T = Actuator current at temperature, T

I_A = Room temperature actuator current – see data sheet

T = Temperature of interest in °C

Magnetic Sensitivity

An electro-mechanical switch can be sensitive to ferrous materials and external magnetic fields. Neighboring ferrous materials should be permitted no closer than 0.5 inches and adjacent external magnetic fields should be limited to a flux density of less than 5

SPECIAL FEATURE

Switching High-Power or Highly Sensitive Signals

Ensure the most linear response with the best galvanically matched contact system in the industry. Extremely low passive intermodulation is standard on all of our switches.

Carrier Frequency 1	Carrier Frequency 2	PIM 3rd Order Frequency	PIM 5th Order Frequency
870 MHz	893 MHz	847 MHz	824 MHz

Multiple Positions	3rd Order Intermodulation	5th Order Intermodulation
	-96 dBm	-115 dBm
	-139 dBc	-158 dBc

LATCHING CCT-59S/CT-59S PART NUMBER LIST

	PART No.		PART No.		PART No.		PART No.
1	CCT-59SX3C	43	CCT-59SX3O-TMS	85	CCT-59SX4O-DM	127	CCT-59SX5C-DS
2	CCT-59SX3C-D	44	CCT-59SX3O-TS	86	CCT-59SX4O-DR	128	CCT-59SX5C-M
3	CCT-59SX3C-DM	45	CCT-59SX3D	87	CCT-59SX4O-DRM	129	CCT-59SX5C-MS
4	CCT-59SX3C-DR	46	CCT-59SX3D-M	88	CCT-59SX4O-DRS	130	CCT-59SX5C-R
5	CCT-59SX3C-DRM	47	CCT-59SX3D-MS	89	CCT-59SX4O-DS	131	CCT-59SX5C-RM
6	CCT-59SX3C-DRS	48	CCT-59SX3D-R	90	CCT-59SX4O-M	132	CCT-59SX5C-RMS
7	CCT-59SX3C-DS	49	CCT-59SX3D-RM	91	CCT-59SX4O-MS	133	CCT-59SX5C-RS
8	CCT-59SX3C-M	50	CCT-59SX3D-RMS	92	CCT-59SX4O-R	134	CCT-59SX5C-S
9	CCT-59SX3C-MS	51	CCT-59SX3D-RS	93	CCT-59SX4O-RM	135	CCT-59SX5C-T
10	CCT-59SX3C-R	52	CCT-59SX3D-S	94	CCT-59SX4O-RMS	136	CCT-59SX5C-TD
11	CCT-59SX3C-RM	53	CCT-59SX3D-T	95	CCT-59SX4O-RS	137	CCT-59SX5C-TDM
12	CCT-59SX3C-RMS	54	CCT-59SX3D-TD	96	CCT-59SX4O-S	138	CCT-59SX5C-TDMS
13	CCT-59SX3C-RS	55	CCT-59SX3D-TDM	97	CCT-59SX4O-T	139	CCT-59SX5C-TDS
14	CCT-59SX3C-S	56	CCT-59SX3D-TDMS	98	CCT-59SX4O-TD	140	CCT-59SX5C-TM
15	CCT-59SX3C-T	57	CCT-59SX3D-TDS	99	CCT-59SX4O-TDM	141	CCT-59SX5C-TMS
16	CCT-59SX3C-TD	58	CCT-59SX3D-TM	100	CCT-59SX4O-TDMS	142	CCT-59SX5C-TS
17	CCT-59SX3C-TDM	59	CCT-59SX3D-TMS	101	CCT-59SX4O-TDS	143	CCT-59SX5O
18	CCT-59SX3C-TDMS	60	CCT-59SX3D-TS	102	CCT-59SX4O-TM	144	CCT-59SX5O-D
19	CCT-59SX3C-TDS	61	CCT-59SX4C	103	CCT-59SX4O-TMS	145	CCT-59SX5O-DM
20	CCT-59SX3C-TM	62	CCT-59SX4C-D	104	CCT-59SX4O-TS	146	CCT-59SX5O-DR
21	CCT-59SX3C-TMS	63	CCT-59SX4C-DM	105	CCT-59SX4D	147	CCT-59SX5O-DRM
22	CCT-59SX3C-TS	64	CCT-59SX4C-DR	106	CCT-59SX4D-M	148	CCT-59SX5O-DRS
23	CCT-59SX3O	65	CCT-59SX4C-DRM	107	CCT-59SX4D-MS	149	CCT-59SX5O-DS
24	CCT-59SX3O-D	66	CCT-59SX4C-DRS	108	CCT-59SX4D-R	150	CCT-59SX5O-M
25	CCT-59SX3O-DM	67	CCT-59SX4C-DS	109	CCT-59SX4D-RM	151	CCT-59SX5O-MS
26	CCT-59SX3O-DR	68	CCT-59SX4C-M	110	CCT-59SX4D-RMS	152	CCT-59SX5O-R
27	CCT-59SX3O-DRM	69	CCT-59SX4C-MS	111	CCT-59SX4D-RS	153	CCT-59SX5O-RM
28	CCT-59SX3O-DRS	70	CCT-59SX4C-R	112	CCT-59SX4D-S	154	CCT-59SX5O-RMS
29	CCT-59SX3O-DS	71	CCT-59SX4C-RM	113	CCT-59SX4D-T	155	CCT-59SX5O-RS
30	CCT-59SX3O-M	72	CCT-59SX4C-RMS	114	CCT-59SX4D-TD	156	CCT-59SX5O-S
31	CCT-59SX3O-MS	73	CCT-59SX4C-RS	115	CCT-59SX4D-TDM	157	CCT-59SX5O-T
32	CCT-59SX3O-R	74	CCT-59SX4C-S	116	CCT-59SX4D-TDMS	158	CCT-59SX5O-TD
33	CCT-59SX3O-RM	75	CCT-59SX4C-T	117	CCT-59SX4D-TDS	159	CCT-59SX5O-TDM
34	CCT-59SX3O-RMS	76	CCT-59SX4C-TD	118	CCT-59SX4D-TM	160	CCT-59SX5O-TDMS
35	CCT-59SX3O-RS	77	CCT-59SX4C-TDM	119	CCT-59SX4D-TMS	161	CCT-59SX5O-TDS
36	CCT-59SX3O-S	78	CCT-59SX4C-TDMS	120	CCT-59SX4D-TS	162	CCT-59SX5O-TM
37	CCT-59SX3O-T	79	CCT-59SX4C-TDS	121	CCT-59SX5C	163	CCT-59SX5O-TMS
38	CCT-59SX3O-TD	80	CCT-59SX4C-TM	122	CCT-59SX5C-D	164	CCT-59SX5O-TS
39	CCT-59SX3O-TDM	81	CCT-59SX4C-TMS	123	CCT-59SX5C-DM	165	CCT-59SX5D
40	CCT-59SX3O-TDMS	82	CCT-59SX4C-TS	124	CCT-59SX5C-DR	166	CCT-59SX5D-M
41	CCT-59SX3O-TDS	83	CCT-59SX4O	125	CCT-59SX5C-DRM	167	CCT-59SX5D-MS
42	CCT-59SX3O-TM	84	CCT-59SX4O-D	126	CCT-59SX5C-DRS	168	CCT-59SX5D-R

* X = 6 (28Vdc), 7 (15Vdc), 8 (12Vdc) and 9 (24Vdc)

Series CCT-59S/CT-59S

Multi-Throw DC-26.5 GHz

Latching Coaxial Switch



TELEDYNE
COAX SWITCHES
Everywhereyoulook™

LATCHING CCT-59S/CT-59S PART NUMBER LIST

	PART No.		PART No.		PART No.		PART No.
169	CCT-59SX5D-RM	211	CCT-59SX6O-MS	253	CT-59SX3C-RS	295	CT-59SX3D-TDM
170	CCT-59SX5D-RMS	212	CCT-59SX6O-R	254	CT-59SX3C-S	296	CT-59SX3D-TDMS
171	CCT-59SX5D-RS	213	CCT-59SX6O-RM	255	CT-59SX3C-T	297	CT-59SX3D-TDS
172	CCT-59SX5D-S	214	CCT-59SX6O-RMS	256	CT-59SX3C-TD	298	CT-59SX3D-TM
173	CCT-59SX5D-T	215	CCT-59SX6O-RS	257	CT-59SX3C-TDM	299	CT-59SX3D-TMS
174	CCT-59SX5D-TD	216	CCT-59SX6O-S	258	CT-59SX3C-TDMS	300	CT-59SX3D-TS
175	CCT-59SX5D-TDM	217	CCT-59SX6O-T	259	CT-59SX3C-TDS	301	CT-59SX4C
176	CCT-59SX5D-TDMS	218	CCT-59SX6O-TD	260	CT-59SX3C-TM	302	CT-59SX4C-D
177	CCT-59SX5D-TDS	219	CCT-59SX6O-TDM	261	CT-59SX3C-TMS	303	CT-59SX4C-DM
178	CCT-59SX5D-TM	220	CCT-59SX6O-TDMS	262	CT-59SX3C-TS	304	CT-59SX4C-DR
179	CCT-59SX5D-TMS	221	CCT-59SX6O-TDS	263	CT-59SX3O	305	CT-59SX4C-DRM
180	CCT-59SX5D-TS	222	CCT-59SX6O-TM	264	CT-59SX3O-D	306	CT-59SX4C-DRS
181	CCT-59SX6C	223	CCT-59SX6O-TMS	265	CT-59SX3O-DM	307	CT-59SX4C-DS
182	CCT-59SX6C-D	224	CCT-59SX6O-TS	266	CT-59SX3O-DR	308	CT-59SX4C-M
183	CCT-59SX6C-DM	225	CCT-59SX6D	267	CT-59SX3O-DRM	309	CT-59SX4C-MS
184	CCT-59SX6C-DR	226	CCT-59SX6D-M	268	CT-59SX3O-DRS	310	CT-59SX4C-R
185	CCT-59SX6C-DRM	227	CCT-59SX6D-MS	269	CT-59SX3O-DS	311	CT-59SX4C-RM
186	CCT-59SX6C-DRS	228	CCT-59SX6D-R	270	CT-59SX3O-M	312	CT-59SX4C-RMS
187	CCT-59SX6C-DS	229	CCT-59SX6D-RM	271	CT-59SX3O-MS	313	CT-59SX4C-RS
188	CCT-59SX6C-M	230	CCT-59SX6D-RMS	272	CT-59SX3O-R	314	CT-59SX4C-S
189	CCT-59SX6C-MS	231	CCT-59SX6D-RS	273	CT-59SX3O-RM	315	CT-59SX4C-T
190	CCT-59SX6C-R	232	CCT-59SX6D-S	274	CT-59SX3O-RMS	316	CT-59SX4C-TD
191	CCT-59SX6C-RM	233	CCT-59SX6D-T	275	CT-59SX3O-RS	317	CT-59SX4C-TDM
192	CCT-59SX6C-RMS	234	CCT-59SX6D-TD	276	CT-59SX3O-S	318	CT-59SX4C-TDMS
193	CCT-59SX6C-RS	235	CCT-59SX6D-TDM	277	CT-59SX3O-T	319	CT-59SX4C-TDS
194	CCT-59SX6C-S	236	CCT-59SX6D-TDMS	278	CT-59SX3O-TD	320	CT-59SX4C-TM
195	CCT-59SX6C-T	237	CCT-59SX6D-TDS	279	CT-59SX3O-TDM	321	CT-59SX4C-TMS
196	CCT-59SX6C-TD	238	CCT-59SX6D-TM	280	CT-59SX3O-TDMS	322	CT-59SX4C-TS
197	CCT-59SX6C-TDM	239	CCT-59SX6D-TMS	281	CT-59SX3O-TDS	323	CT-59SX4O
198	CCT-59SX6C-TDMS	240	CCT-59SX6D-TS	282	CT-59SX3O-TM	324	CT-59SX4O-D
199	CCT-59SX6C-TDS	241	CT-59SX3C	283	CT-59SX3O-TMS	325	CT-59SX4O-DM
200	CCT-59SX6C-TM	242	CT-59SX3C-D	284	CT-59SX3O-TS	326	CT-59SX4O-DR
201	CCT-59SX6C-TMS	243	CT-59SX3C-DM	285	CT-59SX3D	327	CT-59SX4O-DRM
202	CCT-59SX6C-TS	244	CT-59SX3C-DR	286	CT-59SX3D-M	328	CT-59SX4O-DRS
203	CCT-59SX6O	245	CT-59SX3C-DRM	287	CT-59SX3D-MS	329	CT-59SX4O-DS
204	CCT-59SX6O-D	246	CT-59SX3C-DRS	288	CT-59SX3D-R	330	CT-59SX4O-M
205	CCT-59SX6O-DM	247	CT-59SX3C-DS	289	CT-59SX3D-RM	331	CT-59SX4O-MS
206	CCT-59SX6O-DR	248	CT-59SX3C-M	290	CT-59SX3D-RMS	332	CT-59SX4O-R
207	CCT-59SX6O-DRM	249	CT-59SX3C-MS	291	CT-59SX3D-RS	333	CT-59SX4O-RM
208	CCT-59SX6O-DRS	250	CT-59SX3C-R	292	CT-59SX3D-S	334	CT-59SX4O-RMS
209	CCT-59SX6O-DS	251	CT-59SX3C-RM	293	CT-59SX3D-T	335	CT-59SX4O-RS
210	CCT-59SX6O-M	252	CT-59SX3C-RMS	294	CT-59SX3D-TD	336	CT-59SX4O-S

* X = 6 (28Vdc), 7 (15Vdc), 8 (12Vdc) and 9 (24Vdc)

LATCHING CCT-59S/CT-59S PART NUMBER LIST

	PART No.		PART No.		PART No.		PART No.
337	CT-59SX40-T	379	CT-59SX5C-TDS	421	CT-59SX6C	463	CT-59SX6O-TMS
338	CT-59SX40-TD	380	CT-59SX5C-TM	422	CT-59SX6C-D	464	CT-59SX6O-TS
339	CT-59SX40-TDM	381	CT-59SX5C-TMS	423	CT-59SX6C-DM	465	CT-59SX6D
340	CT-59SX40-TDMS	382	CT-59SX5C-TS	424	CT-59SX6C-DR	466	CT-59SX6D-M
341	CT-59SX40-TDS	383	CT-59SX5O	425	CT-59SX6C-DRM	467	CT-59SX6D-MS
342	CT-59SX40-TM	384	CT-59SX5O-D	426	CT-59SX6C-DRS	468	CT-59SX6D-R
343	CT-59SX40-TMS	385	CT-59SX5O-DM	427	CT-59SX6C-DS	469	CT-59SX6D-RM
344	CT-59SX40-TS	386	CT-59SX5O-DR	428	CT-59SX6C-M	470	CT-59SX6D-RMS
345	CT-59SX4D	387	CT-59SX5O-DRM	429	CT-59SX6C-MS	471	CT-59SX6D-RS
346	CT-59SX4D-M	388	CT-59SX5O-DRS	430	CT-59SX6C-R	472	CT-59SX6D-S
347	CT-59SX4D-MS	389	CT-59SX5O-DS	431	CT-59SX6C-RM	473	CT-59SX6D-T
348	CT-59SX4D-R	390	CT-59SX5O-M	432	CT-59SX6C-RMS	474	CT-59SX6D-TD
349	CT-59SX4D-RM	391	CT-59SX5O-MS	433	CT-59SX6C-RS	475	CT-59SX6D-TDM
350	CT-59SX4D-RMS	392	CT-59SX5O-R	434	CT-59SX6C-S	476	CT-59SX6D-TDMS
351	CT-59SX4D-RS	393	CT-59SX5O-RM	435	CT-59SX6C-T	477	CT-59SX6D-TDS
352	CT-59SX4D-S	394	CT-59SX5O-RMS	436	CT-59SX6C-TD	478	CT-59SX6D-TM
353	CT-59SX4D-T	395	CT-59SX5O-RS	437	CT-59SX6C-TDM	479	CT-59SX6D-TMS
354	CT-59SX4D-TD	396	CT-59SX5O-S	438	CT-59SX6C-TDMS	480	CT-59SX6D-TS
355	CT-59SX4D-TDM	397	CT-59SX5O-T	439	CT-59SX6C-TDS		
356	CT-59SX4D-TDMS	398	CT-59SX5O-TD	440	CT-59SX6C-TM		
357	CT-59SX4D-TDS	399	CT-59SX5O-TDM	441	CT-59SX6C-TMS		
358	CT-59SX4D-TM	400	CT-59SX5O-TDMS	442	CT-59SX6C-TS		
359	CT-59SX4D-TMS	401	CT-59SX5O-TDS	443	CT-59SX6O		
360	CT-59SX4D-TS	402	CT-59SX5O-TM	444	CT-59SX6O-D		
361	CT-59SX5C	403	CT-59SX5O-TMS	445	CT-59SX6O-DM		
362	CT-59SX5C-D	404	CT-59SX5O-TS	446	CT-59SX6O-DR		
363	CT-59SX5C-DM	405	CT-59SX5D	447	CT-59SX6O-DRM		
364	CT-59SX5C-DR	406	CT-59SX5D-M	448	CT-59SX6O-DRS		
365	CT-59SX5C-DRM	407	CT-59SX5D-MS	449	CT-59SX6O-DS		
366	CT-59SX5C-DRS	408	CT-59SX5D-R	450	CT-59SX6O-M		
367	CT-59SX5C-DS	409	CT-59SX5D-RM	451	CT-59SX6O-MS		
368	CT-59SX5C-M	410	CT-59SX5D-RMS	452	CT-59SX6O-R		
369	CT-59SX5C-MS	411	CT-59SX5D-RS	453	CT-59SX6O-RM		
370	CT-59SX5C-R	412	CT-59SX5D-S	454	CT-59SX6O-RMS		
371	CT-59SX5C-RM	413	CT-59SX5D-T	455	CT-59SX6O-RS		
372	CT-59SX5C-RMS	414	CT-59SX5D-TD	456	CT-59SX6O-S		
373	CT-59SX5C-RS	415	CT-59SX5D-TDM	457	CT-59SX6O-T		
374	CT-59SX5C-S	416	CT-59SX5D-TDMS	458	CT-59SX6O-TD		
375	CT-59SX5C-T	417	CT-59SX5D-TDS	459	CT-59SX6O-TDM		
376	CT-59SX5C-TD	418	CT-59SX5D-TM	460	CT-59SX6O-TDMS		
377	CT-59SX5C-TDM	419	CT-59SX5D-TMS	461	CT-59SX6O-TDS		
378	CT-59SX5C-TDMS	420	CT-59SX5D-TS	462	CT-59SX6O-TM		

* X = 6 (28Vdc), 7 (15Vdc), 8 (12Vdc) and 9 (24Vdc)