

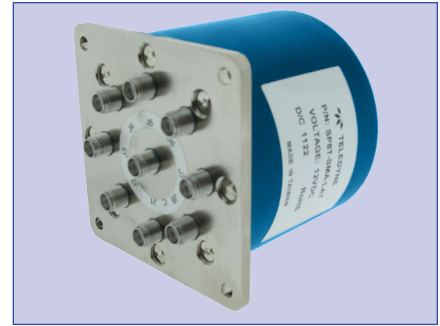

PART NUMBER	DESCRIPTION
CCT-39S	Commercial Latching Multi-throw, DC-12GHz
<p>The CCT-39S is a broadband, multi-throw, electromechanical coaxial switch designed to switch a microwave signal from a common input to any of 7 or 8 outputs. The characteristic impedance is 50 Ohms. Each position has an individual actuator mechanism allowing random position selection. This also minimizes switching time.</p> <p>The CCT-39S comes with a latching actuator. The latching switch remains in the last position selected when the switch is de-energized. STD dual command requires a reset pulse before a new selected position. A separate reset circuit allows all positions to be set to an open position. User must provide both reset (clear) and set (select new position) commands.</p>	



ENVIRONMENTAL AND PHYSICAL CHARACTERISTICS	
Operating Temperature Commercial Model, CCT-39S	-25°C to 65°C
Vibration (MIL-STD-202 Method 214, Condition D, non-operating)	10 g's RMS
Shock (MIL-STD-202 Method 213, Condition D, non-operating)	500 g's
Standard Actuator Life	3,000,000 cycles
Actuator Life w/ Additional Features	1,000,000 cycles
Connector Type	SMA
Humidity (Moisture Seal)	Available
Weight	9 oz. (255.2g) (max.)

ELECTRICAL CHARACTERISTICS	
Form Factor	Multi-Throw, break before make
Frequency Range CCT-39S	DC-12 GHz
Characteristic Impedance	50 Ohms
Operate Time	20 ms (max.)
Actuation Voltage Available	12 15 24 28 V
Actuation Current	140 105 90 105 mA
Reset Currents (# of positions)	
	(7) 980 735 630 735 mA
	(8) 1120 840 720 840 mA

TYPICAL PERFORMANCE CHARACTERISTICS		
Frequency	DC-6 GHz	6-12 GHz
Insertion Loss, dB, max.	0.20	0.40
Isolation, dB, min.	70	60
VSWR, max.	1.30:1	1.40:1

For maximum limits, please see charts on pages 7

### PART NUMBERING SYSTEM

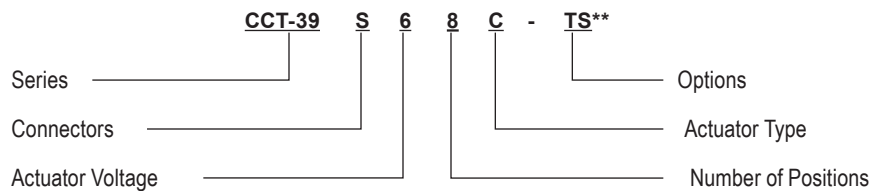

CONNECTOR	ACTUATOR VOLTAGE	NUMBER OF POSITIONS	ACTUATOR TYPE	OPTIONS
S: SMA FEMALE	6: 28 VDC LATCHING	7: SP7T	0: NO INDICATOR CONTACTS	T: TTL DRIVERS WITH DIODES
	7: 15 VDC LATCHING	8: SP8T	C: INDICATOR CONTACTS	D: COIL TRANSIENT SUPPRESSION DIODES
	8: 12 VDC LATCHING		D: SELF CUTOFF ONLY	R: POSITIVE + COMMON
	9: 24 VDC LATCHING		E: INDICATORS AND SELF CUTOFF	TD: DECODERS AND TTL DRIVERS WITH DIODES
				M: MOISTURE SEAL
				S: D-SUB CONNECTOR*

For additional options, please contact factory.

\* D-Sub Connector may be 15 or 25 pin depending on number of throws. (See Connector Pinout page)  
\*\* D-Sub Connectors are standard configuration on all models unless otherwise specified

**SCHEMATICS AND MECHANICAL OUTLINE**

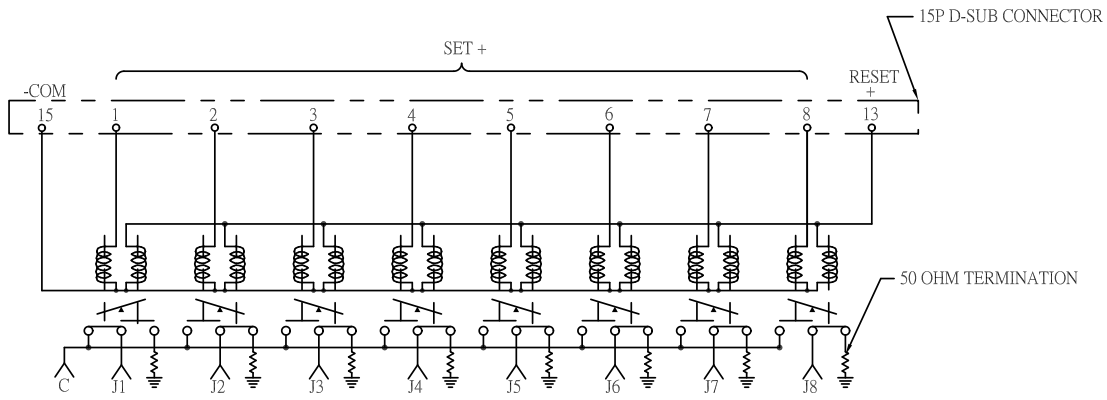

SCHEMATIC  
 COIL 1 SHOWN LAST ENERGIZE

**Standard Model**

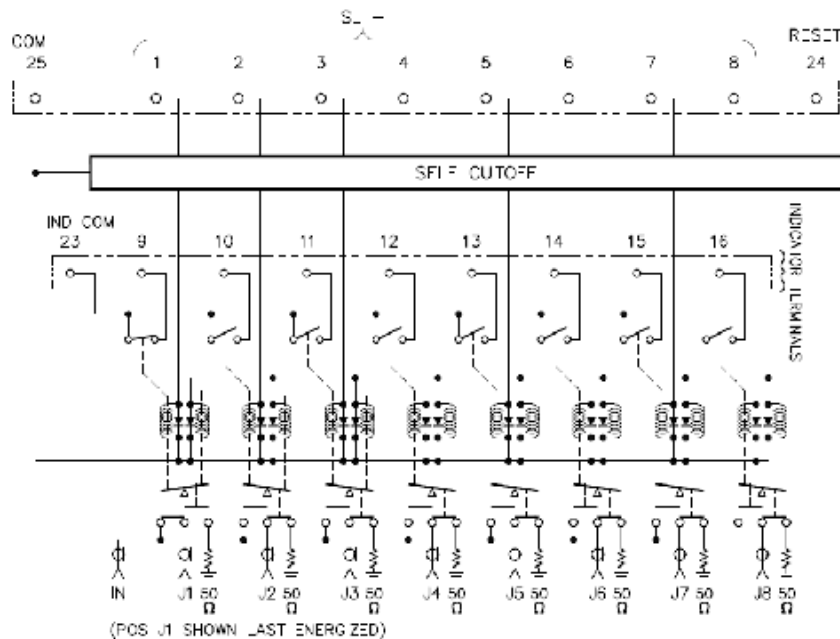

SCHEMATIC

**Self Cutoff & Indicator**

**SCHEMATICS AND MECHANICAL OUTLINE**

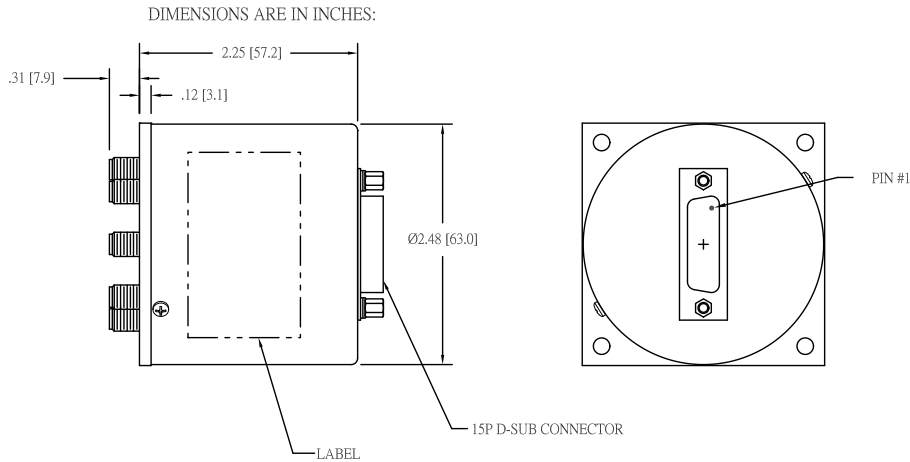
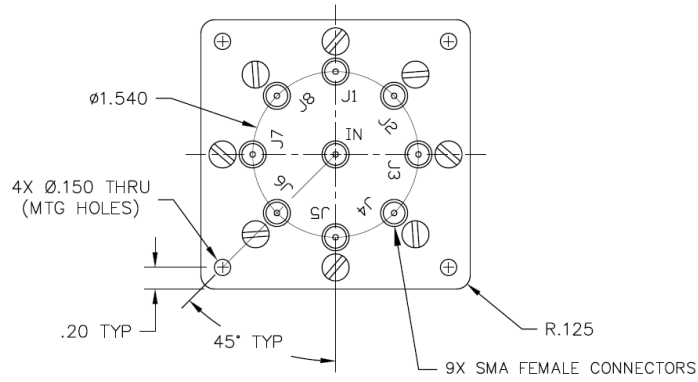

**Standard Model**

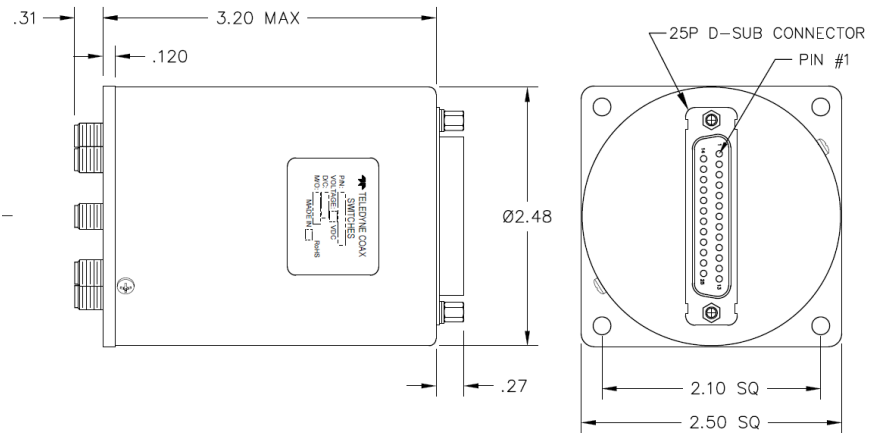

**Self Cuffout & Indicator / TTL & D-sub**

**Series CCT-39S**  
**Multi-Throw DC-12 GHz, SP7T & SP8T**  
**Latching Coaxial Switch, Internal 50Ω Termination**



CONNECTOR PINOUT FOR LATCHING SP7T MULTI-THROW SWITCHES						
EXAMPLE	CCT-39S670-S	CCT-39S67C-S	CCT-39S670-TS	CCT-39S67C-TS	CCT-39S670-TDS	CCT-39S67C-TDS
INDICATOR		Yes		Yes		Yes
TTL			Yes	Yes		
Decoders & TTL					Yes	Yes
PIN NO.	15-PIN	25-PIN	15-PIN	25-PIN	15-PIN	25-PIN
1	PORT 1	PORT 1	TTL 1	TTL 1	LOGIC 1	LOGIC 1
2	PORT 2	PORT 2	TTL 2	TTL 2	LOGIC 2	LOGIC 2
3	PORT 3	PORT 3	TTL 3	TTL 3	LOGIC 3	LOGIC 3
4	PORT 4	PORT 4	TTL 4	TTL 4		
5	PORT 5	PORT 5	TTL 5	TTL 5		
6	PORT 6	PORT 6	TTL 6	TTL 6		
7	PORT 7	PORT 7	TTL 7	TTL 7		
8						
9		E Indicator		E Indicator		E Indicator
10		F Indicator		F Indicator		F Indicator
11		G Indicator		G Indicator		G Indicator
12		H Indicator		H Indicator		H Indicator
13		K Indicator	Vsw	K Indicator	Vsw	K Indicator
14	Reset	L Indicator	Reset	L Indicator		L Indicator
15	COMMON	M Indicator	COMMON	M Indicator	COMMON	M Indicator
16						
17						
18						
19						
20						
21						
22						
23		D Indicator (COM)		D Indicator (COM)		D Indicator (COM)
24		Reset		Reset		Reset
25		COMMON		COMMON		COMMON

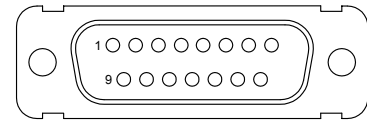

**15-PIN D-SUB CONNECTOR**

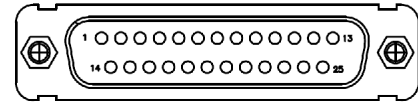

**25-PIN D-SUB CONNECTOR**

SP7T TRUTH TABLE Latching  
CCT-39SX7C-T

Logic Input								RF Path								Indicator Switches						
1	2	3	4	5	6	7	R	J1	J2	J3	J4	J5	J6	J7	Reset	E	F	G	H	K	L	M
1	0	0	0	0	0	0	0	On	Off	Off	Off	Off	Off	Off	Off	C	0	0	0	0	0	0
0	1	0	0	0	0	0	0	Off	On	Off	Off	Off	Off	Off	Off	0	C	0	0	0	0	0
0	0	1	0	0	0	0	0	Off	Off	On	Off	Off	Off	Off	Off	0	0	C	0	0	0	0
0	0	0	1	0	0	0	0	Off	Off	Off	On	Off	Off	Off	Off	0	0	0	C	0	0	0
0	0	0	0	1	0	0	0	Off	Off	Off	Off	On	Off	Off	Off	0	0	0	0	C	0	0
0	0	0	0	0	1	0	0	Off	Off	Off	Off	Off	On	Off	Off	0	0	0	0	0	C	0
0	0	0	0	0	0	1	0	Off	Off	Off	Off	Off	Off	On	Off	0	0	0	0	0	0	C

TRUTH TABLE Latching  
CCT-39SX7C-TD

Logic Input				RF Path							Indicator Switches							
1	2	3	4	J1	J2	J3	J4	J5	J6	J7	Reset	E	F	G	H	K	L	M
0	0	0	0	On	Off	Off	Off	Off	Off	Off	Off	C	0	0	0	0	0	0
1	0	0	0	Off	On	Off	Off	Off	Off	Off	Off	0	C	0	0	0	0	0
0	1	0	0	Off	Off	On	Off	Off	Off	Off	Off	0	0	C	0	0	0	0
1	1	0	0	Off	Off	Off	On	Off	Off	Off	Off	0	0	0	C	0	0	0
0	0	1	0	Off	Off	Off	Off	On	Off	Off	Off	0	0	0	0	C	0	0
1	0	1	0	Off	Off	Off	Off	Off	On	Off	Off	0	0	0	0	0	C	0
0	1	1	0	Off	Off	Off	Off	Off	Off	On	Off	0	0	0	0	0	0	C
1	1	1	0	Off	Off	Off	Off	Off	Off	Off	Reset	0	0	0	0	0	0	0
1	1	1	1	COIL OFF							0	0	0	0	0	0	0	

**Series CCT-39S**  
**Multi-Throw DC-12 GHz, SP7T & SP8T**  
**Latching Coaxial Switch, Internal 50Ω Termination**



CONNECTOR PINOUT FOR LATCHING SP8T MULTI-THROW SWITCHES						
EXAMPLE	CCT-39S680-S	CCT-39S68C-S	CCT-39S680-TS	CCT-39S68C-TS	CCT-39S680-TDS	CCT-39S68C-TDS
INDICATOR		Yes		Yes		Yes
TTL			Yes	Yes		
DECODERS & TTL					Yes	Yes
PIN NO.	15-PIN	25-PIN	15-PIN	25-PIN	15-PIN	25-PIN
1	PORT 1	PORT 1	TTL 1	TTL 1	LOGIC 1	LOGIC 1
2	PORT 2	PORT 2	TTL 2	TTL 2	LOGIC 2	LOGIC 2
3	PORT 3	PORT 3	TTL 3	TTL 3	LOGIC 3	LOGIC 3
4	PORT 4	PORT 4	TTL 4	TTL 4	LOGIC 4	LOGIC 4
5	PORT 5	PORT 5	TTL 5	TTL 5		
6	PORT 6	PORT 6	TTL 6	TTL 6		
7	PORT 7	PORT 7	TTL 7	TTL 7		
8	PORT 8	PORT 8	TTL 8	TTL 8		
9		E Indicator		E Indicator		E Indicator
10		F Indicator		F Indicator		F Indicator
11		G Indicator		G Indicator		G Indicator
12		H Indicator		H Indicator		H Indicator
13		K Indicator	Vsw	K Indicator	Vsw	K Indicator
14	Reset	L Indicator	Reset	L Indicator		L Indicator
15	Common	M Indicator	Common	M Indicator	Common	M Indicator
16		N Indicator		N Indicator		N Indicator
17						
18						
19						
20						
21						
22						
23		D Indicator (COM)		D Indicator (COM)		D Indicator (COM)
24		Reset		Reset		Reset
25		COMMON		COMMON		COMMON

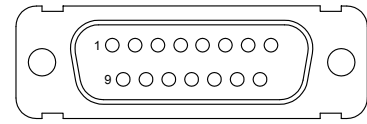

**15-PIN D-SUB CONNECTOR**

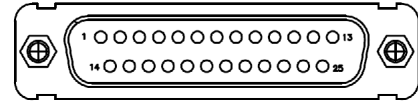

**25-PIN D-SUB CONNECTOR**

SP8T TRUTH TABLE Latching  
CCT-39SX8C-T

Logic Input									RF Path									Indicator Switches								
1	2	3	4	5	6	7	8	R	J1	J2	J3	J4	J5	J6	J7	J8	Reset	E	F	G	H	K	L	M	N	
1	0	0	0	0	0	0	0	0	On	Off	Off	Off	Off	Off	Off	Off	Off	C	0	0	0	0	0	0	0	
0	1	0	0	0	0	0	0	0	Off	On	Off	Off	Off	Off	Off	Off	Off	0	C	0	0	0	0	0	0	
0	0	1	0	0	0	0	0	0	Off	Off	On	Off	Off	Off	Off	Off	Off	0	0	C	0	0	0	0	0	
0	0	0	1	0	0	0	0	0	Off	Off	Off	On	Off	Off	Off	Off	Off	0	0	0	C	0	0	0	0	
0	0	0	0	1	0	0	0	0	Off	Off	Off	Off	On	Off	Off	Off	Off	0	0	0	0	C	0	0	0	
0	0	0	0	0	1	0	0	0	Off	Off	Off	Off	Off	On	Off	Off	Off	0	0	0	0	0	C	0	0	
0	0	0	0	0	0	1	0	0	Off	Off	Off	Off	Off	Off	On	Off	Off	0	0	0	0	0	0	C	0	
0	0	0	0	0	0	0	1	0	Off	Off	Off	Off	Off	Off	Off	On	Off	0	0	0	0	0	0	0	C	
0	0	0	0	0	0	0	0	1	0	Off	Off	Off	Off	Off	Off	Off	On	Off	0	0	0	0	0	0	0	C

TRUTH TABLE Latching  
CCT-39SX8C-TD

Logic Input				RF Path								Indicator Switches								
1	2	3	4	J1	J2	J3	J4	J5	J6	J7	J8	Reset	E	F	G	H	K	L	M	N
0	0	0	0	On	Off	Off	Off	Off	Off	Off	Off	Off	C	0	0	0	0	0	0	0
1	0	0	0	Off	On	Off	Off	Off	Off	Off	Off	Off	0	C	0	0	0	0	0	0
0	1	0	0	Off	Off	On	Off	Off	Off	Off	Off	Off	0	0	C	0	0	0	0	0
1	1	0	0	Off	Off	Off	On	Off	Off	Off	Off	Off	0	0	0	C	0	0	0	0
0	0	1	0	Off	Off	Off	Off	On	Off	Off	Off	Off	0	0	0	0	C	0	0	0
1	0	1	0	Off	Off	Off	Off	Off	On	Off	Off	Off	0	0	0	0	0	C	0	0
0	1	1	0	Off	Off	Off	Off	Off	Off	On	Off	Off	0	0	0	0	0	0	C	0
1	1	1	0	Off	Off	Off	Off	Off	Off	Off	On	Off	0	0	0	0	0	0	0	C
0	0	0	1	Off	Off	Off	Off	Off	Off	Off	Off	Reset	0	0	0	0	0	0	0	0
1	1	1	1	COIL OFF								0	0	0	0	0	0	0	0	

**TYPICAL RF PERFORMANCE CURVES**

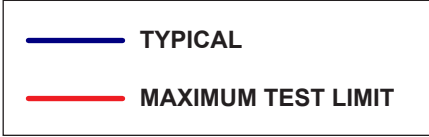
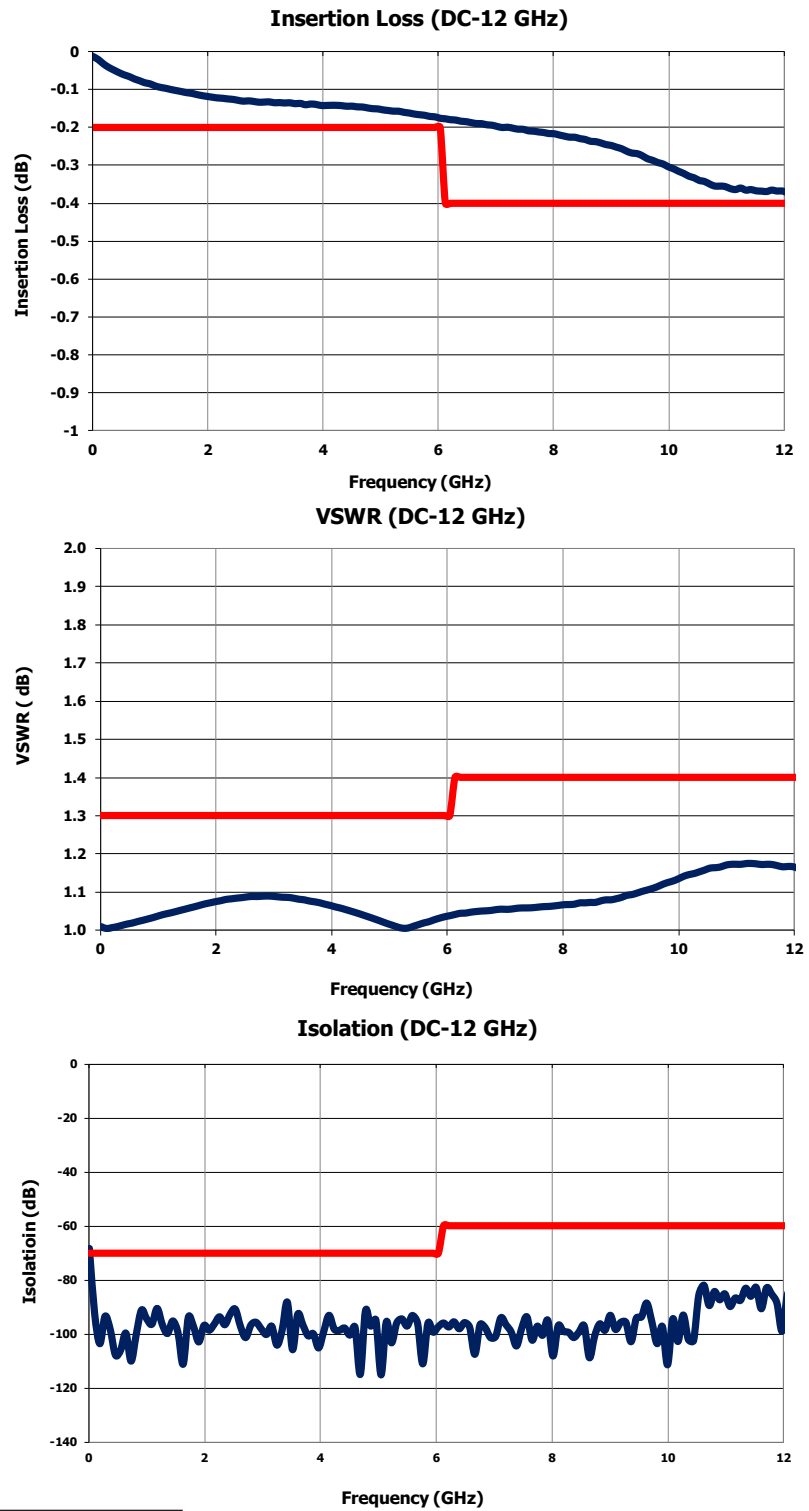



**TYPICAL POWER PERFORMANCE CURVE**

# Power Handling vs. Frequency

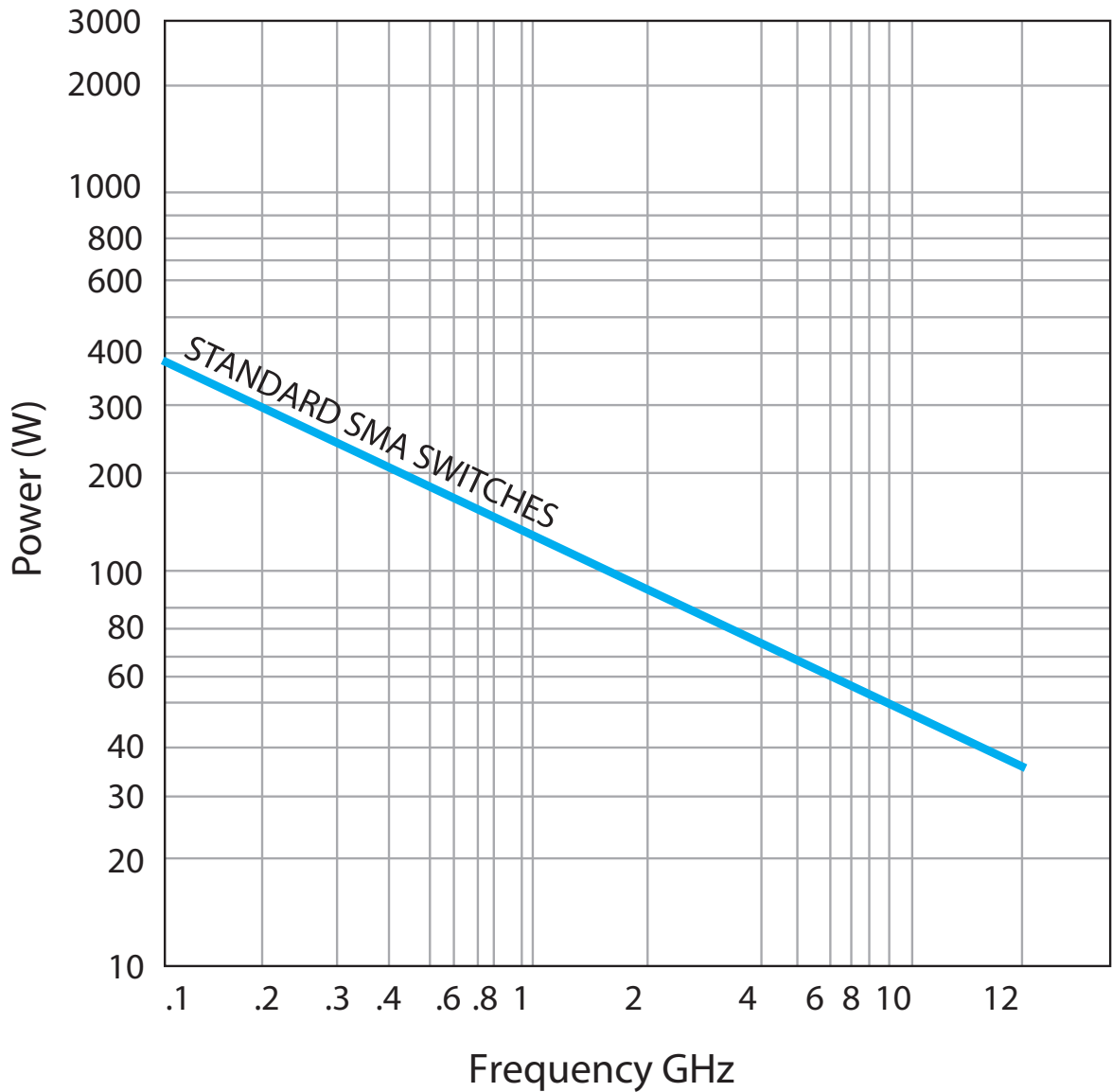

Estimates based on the following reference conditions:

- Ambient temperature of 40°C or less
- Sea level operation
- Load VSWR of 1.20:1 maximum
- No high-power (hot) switching

Please contact Teledyne Coax Switches for derating factors when applications do not meet the foregoing reference conditions.

## GLOSSARY

### Actuator

An actuator is the electromechanical mechanism that transfers the RF contacts from one position to another upon DC command.

### Arc Suppression Diode

A diode is connected in parallel with the coil. This diode limits the "reverse EMF spike" generated when the coil de-energizes to 0.7 volts. The diode cathode is connected to the positive side of the coil and the anode is connected to the negative side.

### Date Code

All switches are marked with either a unique serial number or a date code. Date codes are in accordance with MIL-STD-1285 Paragraph 5.2.5 and consist of four digits. The first two digits define the year and the last two digits define the week of the year (YYWW). Thus, 1032 identifies switches that passed through final inspection during the 32nd week of 2010.

### Indicator

Indicators tell the system which position the switch is in. Other names for indicators are telemetry contacts or tellback circuit. Indicators are usually a set of internally mounted DC contacts linked to the actuator. They can be wired to digital input lines, status lights, or interlocks. Unless otherwise specified, the maximum indicator contact rating is 30 Vdc, 50 mA, or 1.5 Watts into a resistive load.

### Isolation

Isolation is the measure of the power level at the output connector of an unconnected RF channel as referenced to the power at the input connector. It is specified in dB below the input power level.

### Multi-Throw Latching Switch

A multi-throw switch is a switch with one input and three or more output ports. The CCT-39 can switch a microwave signal to any of 8 outputs from a single common input.

### Switching Time

Switching time is the total interval beginning with the arrival of the leading edge of the command pulse at the switch DC input and ending with the completion of the switch transfer, including contact bounce. It consists of three parts: (1) inductive delay in the coil, (2) transfer time of the physical movement of the contacts, and (3) the bounce time of the RF contacts.

### TTL Switch Driver Option

As a special option, switch drivers can be provided for both failsafe and latching switches, which are compatible with industry-standard low-power Schottky TTL circuits.

### TD-Option

This option includes a decoder. The 3-bit parallel command is decoded to internally select the appropriate position. See the logic tables. The TD-Option increases the Vsw supply current demand by 50mA max at 28Vdc and +20°C.

### Performance Parameters vs Frequency

Generally speaking, the RF performance of coaxial switches is frequency dependent. With increasing frequency, VSWR and insertion loss increase while isolation decreases. All data sheets specify these three parameters as "worst case" at the highest operating frequency. If the switch is to be used over a narrow frequency band, better performance can be achieved.

### Actuator Current vs Temperature

The resistance of the actuator coil varies as a function of temperature. There is an inverse relationship between the operating temperature of the switch and the actuator drive current. For switches operating at 28 VDC, the approximate actuator drive current at temperature, T, can be calculated using the equation:

$$I_T = \frac{I_A}{[1 + .00385 (T-20)]}$$

#### Where:

$I_T$  = Actuator current at temperature, T

$I_A$  = Room temperature actuator current – see data sheet

T = Temperature of interest in °C

### Magnetic Sensitivity

An electro-mechanical switch can be sensitive to ferrous materials and external magnetic fields. Neighboring ferrous materials should be permitted no closer than 0.5 inches and adjacent external magnetic fields should be limited to a flux density of less than 5 Gauss.

**LATCHING CCT-39S PART NUMBER LIST**

	PART No.		PART No.		PART No.		PART No.
1	CCT-39SX7C	43	CCT-39SX70-TMS	85	CCT-39SX8C-MS	127	CCT-39SX8D-RS
2	CCT-39SX7C-D	44	CCT-39SX70-TS	86	CCT-39SX8C-R	128	CCT-39SX8D-S
3	CCT-39SX7C-DM	45	CCT-39SX7D	87	CCT-39SX8C-RM	129	CCT-39SX8D-T
4	CCT-39SX7C-DR	46	CCT-39SX7D-M	88	CCT-39SX8C-RMS	130	CCT-39SX8D-TD
5	CCT-39SX7C-DRM	47	CCT-39SX7D-MS	89	CCT-39SX8C-RS	131	CCT-39SX8D-TDM
6	CCT-39SX7C-DRS	48	CCT-39SX7D-R	90	CCT-39SX8C-S	132	CCT-39SX8D-TDMS
7	CCT-39SX7C-DS	49	CCT-39SX7D-RM	91	CCT-39SX8C-T	133	CCT-39SX8D-TDS
8	CCT-39SX7C-M	50	CCT-39SX7D-RMS	92	CCT-39SX8C-TD	134	CCT-39SX8D-TM
9	CCT-39SX7C-MS	51	CCT-39SX7D-RS	93	CCT-39SX8C-TDM	135	CCT-39SX8D-TMS
10	CCT-39SX7C-R	52	CCT-39SX7D-S	94	CCT-39SX8C-TDMS	136	CCT-39SX8D-TS
11	CCT-39SX7C-RM	53	CCT-39SX7D-T	95	CCT-39SX8C-TDS	137	CCT-39SX8E
12	CCT-39SX7C-RMS	54	CCT-39SX7D-TD	96	CCT-39SX8C-TM	138	CCT-39SX8E-M
13	CCT-39SX7C-RS	55	CCT-39SX7D-TDM	97	CCT-39SX8C-TMS	139	CCT-39SX8E-MS
14	CCT-39SX7C-S	56	CCT-39SX7D-TDMS	98	CCT-39SX8C-TS	140	CCT-39SX8E-R
15	CCT-39SX7C-T	57	CCT-39SX7D-TDS	99	CCT-39SX80	141	CCT-39SX8E-RM
16	CCT-39SX7C-TD	58	CCT-39SX7D-TM	100	CCT-39SX80-D	142	CCT-39SX8E-RMS
17	CCT-39SX7C-TDM	59	CCT-39SX7D-TMS	101	CCT-39SX80-DM	143	CCT-39SX8E-RS
18	CCT-39SX7C-TDMS	60	CCT-39SX7D-TS	102	CCT-39SX80-DR	144	CCT-39SX8E-S
19	CCT-39SX7C-TDS	61	CCT-39SX7E	103	CCT-39SX80-DRM	145	CCT-39SX8E-T
20	CCT-39SX7C-TM	62	CCT-39SX7E-M	104	CCT-39SX80-DRS	146	CCT-39SX8E-TD
21	CCT-39SX7C-TMS	63	CCT-39SX7E-MS	105	CCT-39SX80-DS	147	CCT-39SX8E-TDM
22	CCT-39SX7C-TS	64	CCT-39SX7E-R	106	CCT-39SX80-M	148	CCT-39SX8E-TDMS
23	CCT-39SX70	65	CCT-39SX7E-RM	107	CCT-39SX80-MS	149	CCT-39SX8E-TDS
24	CCT-39SX70-D	66	CCT-39SX7E-RMS	108	CCT-39SX80-R	150	CCT-39SX8E-TM
25	CCT-39SX70-DM	67	CCT-39SX7E-RS	109	CCT-39SX80-RM	151	CCT-39SX8E-TMS
26	CCT-39SX70-DR	68	CCT-39SX7E-S	110	CCT-39SX80-RMS	152	CCT-39SX8E-TS
27	CCT-39SX70-DRM	69	CCT-39SX7E-T	111	CCT-39SX80-RS		
28	CCT-39SX70-DRS	70	CCT-39SX7E-TD	112	CCT-39SX80-S		
29	CCT-39SX70-DS	71	CCT-39SX7E-TDM	113	CCT-39SX80-T		
30	CCT-39SX70-M	72	CCT-39SX7E-TDMS	114	CCT-39SX80-TD		
31	CCT-39SX70-MS	73	CCT-39SX7E-TDS	115	CCT-39SX80-TDM		
32	CCT-39SX70-R	74	CCT-39SX7E-TM	116	CCT-39SX80-TDMS		
33	CCT-39SX70-RM	75	CCT-39SX7E-TMS	117	CCT-39SX80-TDS		
34	CCT-39SX70-RMS	76	CCT-39SX7E-TS	118	CCT-39SX80-TM		
35	CCT-39SX70-RS	77	CCT-39SX8C	119	CCT-39SX80-TMS		
36	CCT-39SX70-S	78	CCT-39SX8C-D	120	CCT-39SX80-TS		
37	CCT-39SX70-T	79	CCT-39SX8C-DM	121	CCT-39SX8D		
38	CCT-39SX70-TD	80	CCT-39SX8C-DR	122	CCT-39SX8D-M		
39	CCT-39SX70-TDM	81	CCT-39SX8C-DRM	123	CCT-39SX8D-MS		
40	CCT-39SX70-TDMS	82	CCT-39SX8C-DRS	124	CCT-39SX8D-R		
41	CCT-39SX70-TDS	83	CCT-39SX8C-DS	125	CCT-39SX8D-RM		
42	CCT-39SX70-TM	84	CCT-39SX8C-M	126	CCT-39SX8D-RMS		

\* X = 6 (28Vdc), 7 (15Vdc), 8 (12Vdc) and 9 (24Vdc)