

PART NUMBER	DESCRIPTION
CCS-32	Commercial Failsafe SPDT, DC-12GHz
CS-32	Elite Failsafe SPDT, DC-12GHz

The CCS-32/CS-32 is a broadband, SPDT, electromechanical, coaxial switch designed to switch a microwave signal from a common input to either of two outputs. The characteristic impedance is 50 Ohms. The small switches incorporate Type N or TNC connectors. The CCS-32/CS-32 series switch is offered with a failsafe actuator. This design is compatible with the two most common mounting hole patterns. The CCS-32/CS-32 series switch is interchangeable with a variety of switches.



ENVIRONMENTAL AND PHYSICAL CHARACTERISTICS	
Storage Temperature	-55°C to 90°C
Operating Temperature	
Commercial Model, CCS-32	-25°C to 65°C
Elite Model, CS-32	-55°C to 85°C
CS-32 w/ indicator contacts	-45°C to 85°C
Vibration ¹ , 10 ~ 2000 Hz, 300 s MIL-STD-202 Method 204, Condition C	10 G peak
Shock, Half-Sine Pulse MIL-STD-202 Method 213, Condition D	500 G peak
Moisture Resistance ²	95% RH Non-condensing
Mechanical Life	2,000,000 cycles (min)
RF Contacts Life	1,000,000 cycles (min)
Connector Type	Type N or TNC
Weight	6 oz. (170.1g) (max.)

1. Non-operating
2. When moisture seal option is selected

ELECTRICAL CHARACTERISTICS	
RF Contacts	Break before make
Frequency Range	DC–12 GHz
Characteristic Impedance	50 Ω
Switching Time	20 ms max
Actuation Voltage (Vdc) 20°C	12 15 24 28 V
Actuation Current, max. @ ambient	600 500 300 250 mA
TTL/Decoders Voltage/Current ¹	
Low Level (Logic 0)	0.0 ~ 0.7 V / 3.2 mA Max at 0.7 V
High Level (Logic 1)	2.4 ~ 5.5 V / 80 µA Max at 2.4 V
Indicator Contact Rating ²	30 Vdc, 50 mA max
Magnetic Sensitivity	5 Gauss, 0.5 inch max

1. For switches with TTL driver or decoder
2. For switches with indicator

TYPICAL PERFORMANCE CHARACTERISTICS: N CONNECTOR OPTION (TNC CONNECTOR, 11GHz MAX.)				
Frequency	DC–1 GHz	1–4 GHz	4–10 GHz	10–12 GHz
Insertion Loss, dB, max.	0.3	0.4	0.5	0.5
Isolation, dB, min.	70	60	60	50
VSWR, max.	1.25:1	1.4:1	1.7:1	1.7:1

For maximum limits, please see charts on page 3-5

PART NUMBERING SYSTEM

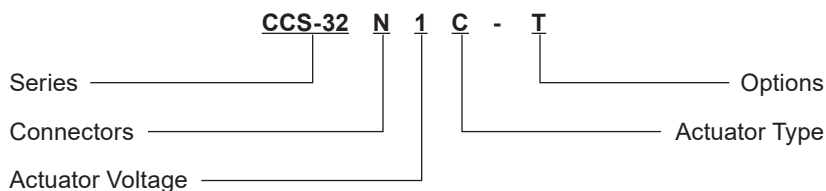

Connector
N: Type N Female
T: TNC Female

Actuator Voltage
1: 28 Vdc Failsafe
2: 15 Vdc Failsafe
3: 12 Vdc Failsafe
4: 24 Vdc Failsafe

Actuator Type
0: Standard Contacts
C: Indicator Contacts

Options
T: TTL Drivers with Diodes
D: Transient Suppression Diodes
M: Moisture Seal
S: 9 Pin D-Sub Connector

For additional options, please contact factory.

SCHEMATICS AND MECHANICAL OUTLINE

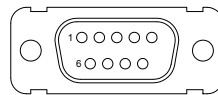
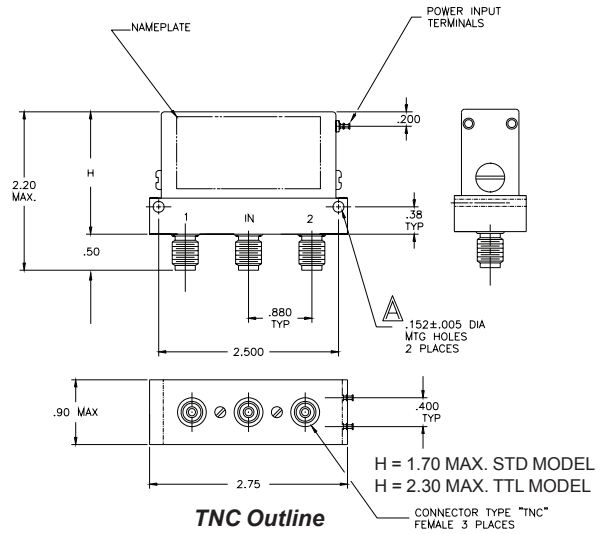
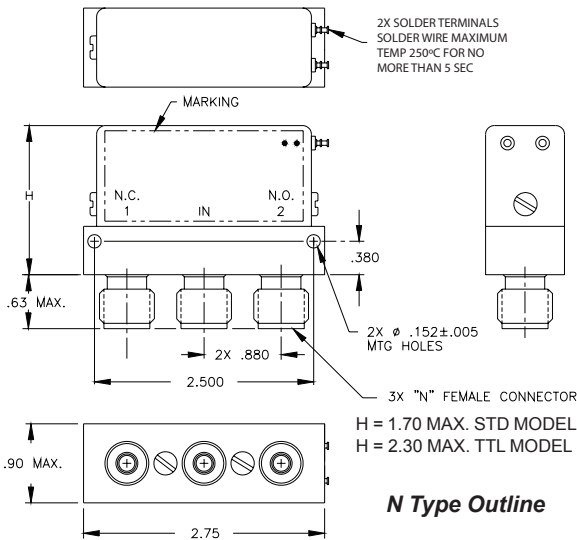
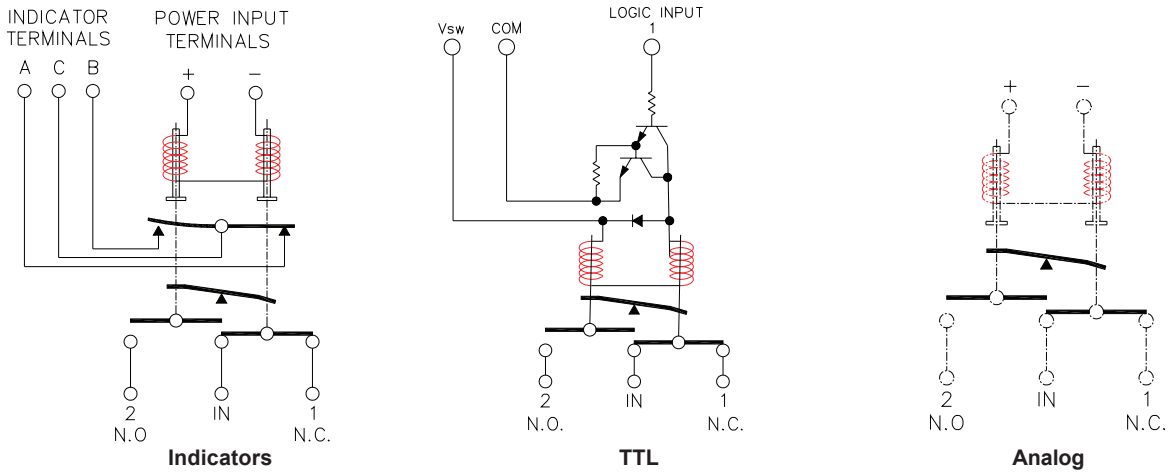

"-S OPTION" 9-PIN D-SUB CONNECTOR (EXAMPLE: CCS-32N10-S)

9 PIN D-SUB PINOUT FOR FAILSAFE SPDT				
Pin No.	OPTIONS			
	Basic	Indicators	TTL	Indicators & TTL
1	+	+		
2	-	-		
3			Common	Common
4			1	1
5				
6			Vsw	Vsw
7		A		A
8		B		B
9		C		C

TRUTH TABLE (with TTL option)				
Logic Input	RF Path		Indicator (if applicable)	
	IN to 1	IN to 2	A	B
0	On	Off	C	0
1	Off	On	0	C

TYPICAL NARROWBAND RF INSERTION LOSS PERFORMANCE CURVES

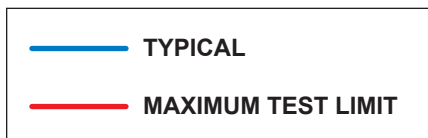
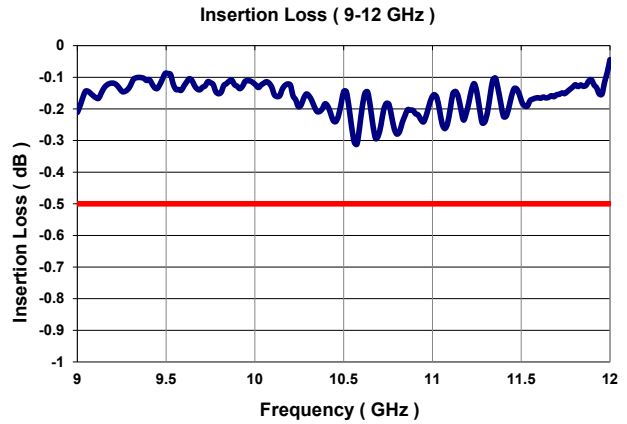
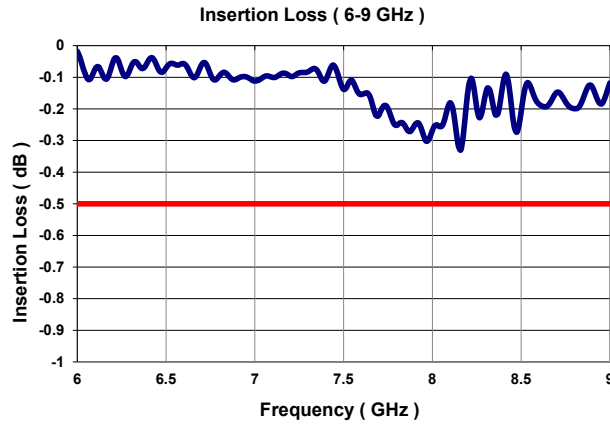
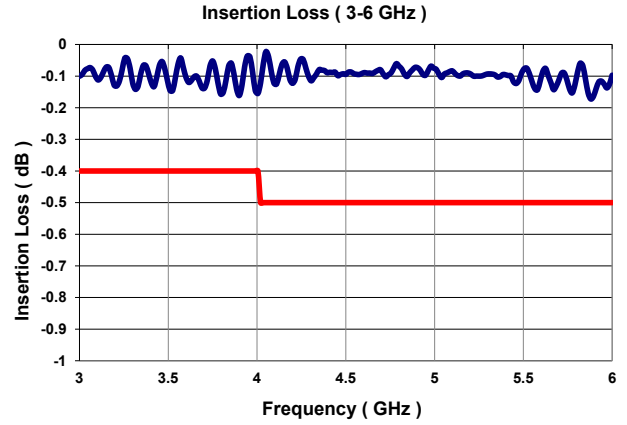
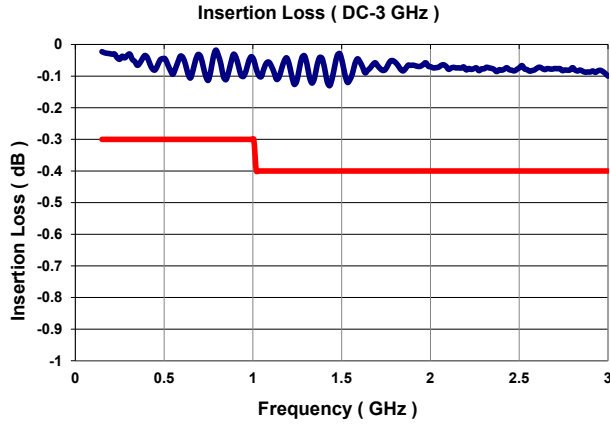

TYPICAL NARROWBAND RF ISOLATION PERFORMANCE CURVES

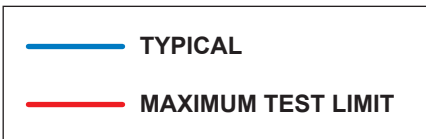
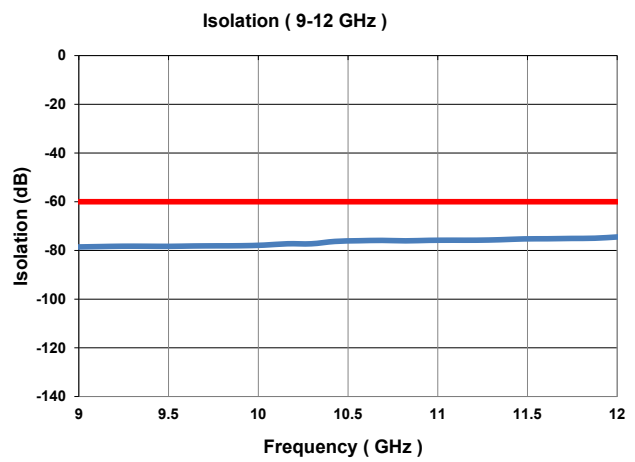
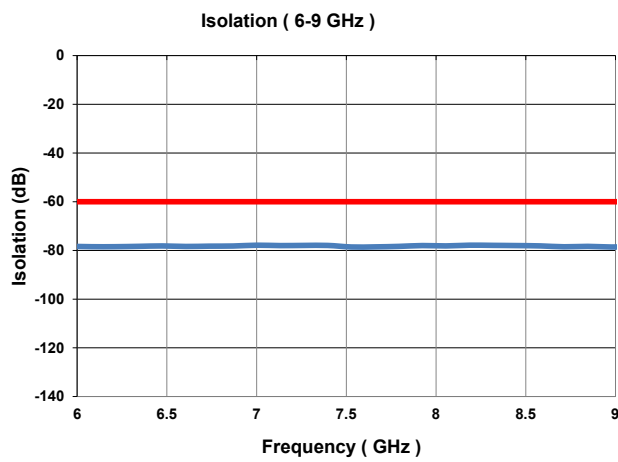
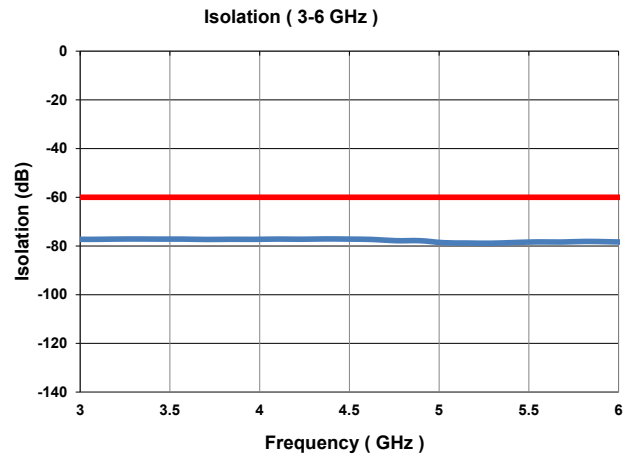
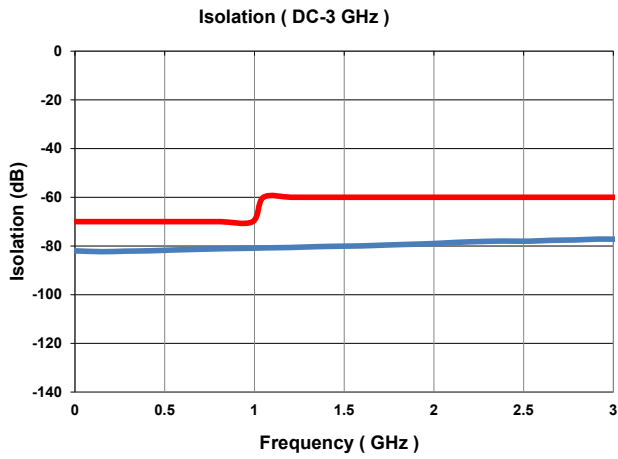

TYPICAL NARROWBAND RF VSWR PERFORMANCE CURVES

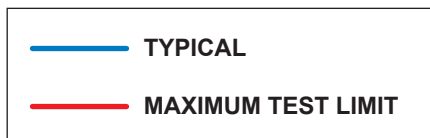
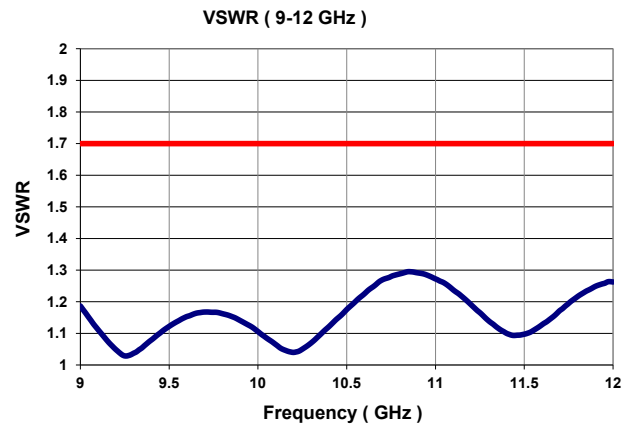
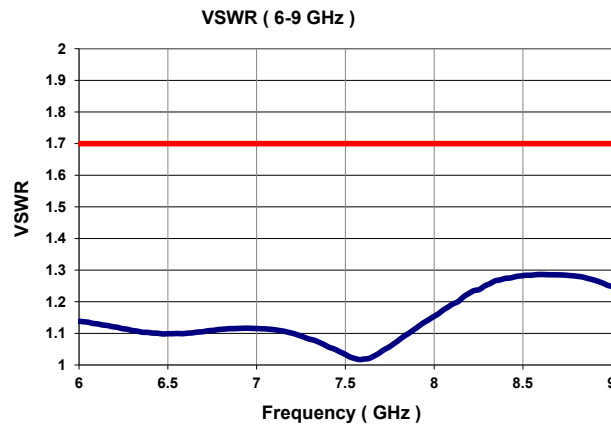
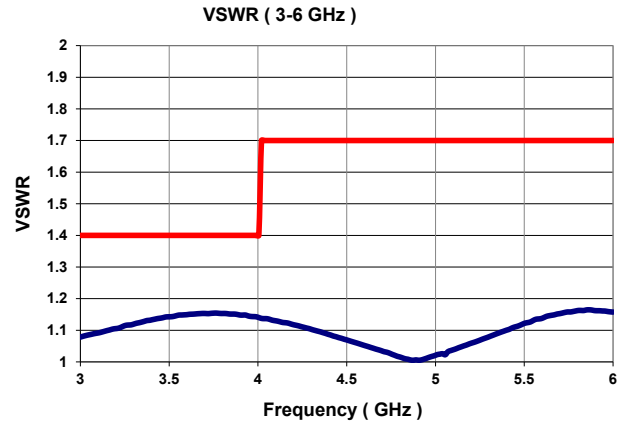
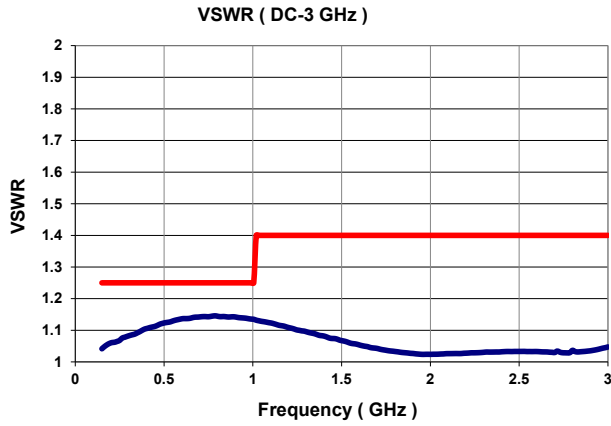

TYPICAL POWER PERFORMANCE CURVE

Power Handling vs. Frequency

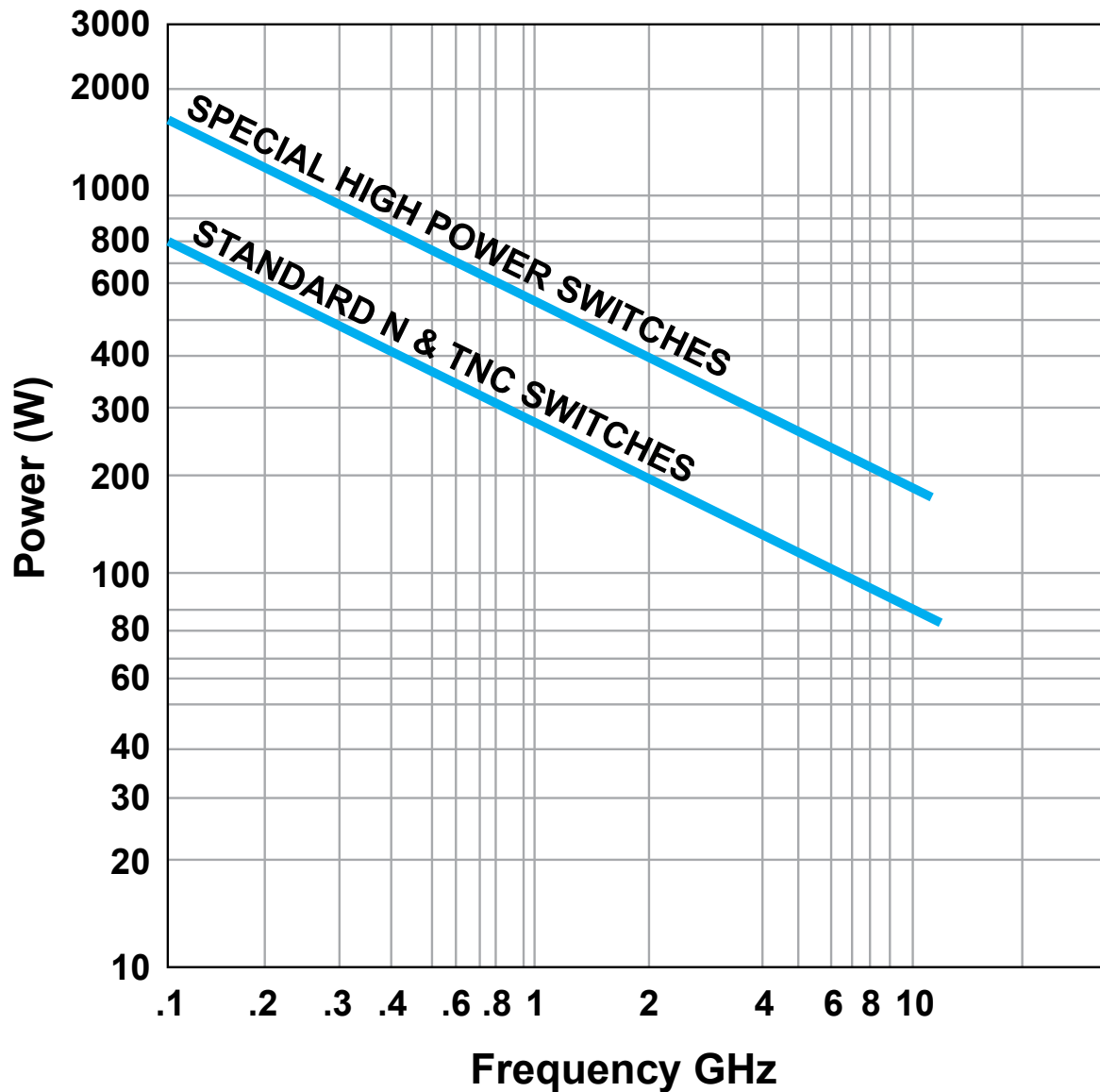

Estimates based on the following reference conditions:

- Ambient temperature of 40°C or less
- Sea level operation
- Load VSWR of 1.20:1 maximum
- No high-power (hot) switching

Please contact Teledyne Coax Switches for derating factors when applications do not meet the foregoing reference conditions.

GLOSSARY

Actuator

An actuator is the electromechanical mechanism that transfers the RF contacts from one position to another upon DC command.

Arc Suppression Diode

A diode is connected in parallel with the coil. This diode limits the “reverse EMF spike” generated when the coil de-energizes to 0.7 volts. The diode cathode is connected to the positive side of the coil and the anode is connected to the negative side.

Date Code

All switches are marked with either a unique serial number or a date code. Date codes are in accordance with MIL-STD-1285 Paragraph 5.2.5 and consist of four digits. The first two digits define the year and the last two digits define the week of the year (YYWW). Thus, 1032 identifies switches that passed through final inspection during the 32nd week of 2010.

Failsafe

A fail-safe switch reverts to the default or fail-safe position when actuating voltage is removed. This is realized by a return spring within the drive mechanism. This type of switch requires the continuous application of operating voltage to select and hold any position. (Multi-position switches are normally open with no voltage applied).

Latching

A latching switch remains in the selected position whether or not voltage is maintained. This can be accomplished with either a magnetic or mechanical latching mechanism.

Indicator

Indicators tell the system which position the switch is in. Other names for indicators are telemetry contacts or tell back circuit. Indicators are usually a set of internally mounted DC contacts linked to the actuator. They can be wired to digital input lines, status lights, or interlocks. Unless otherwise specified, the maximum indicator contact rating is 30 Vdc, 50 mA, or 1.5 Watts into a resistive load.

Internal Termination

Unselected ports are internally terminated to a matched load. The load is 50Ω resistive device. The max RF power rating is 2 Watts CW. Without the internal termination option, the unselected ports are open circuits.

Isolation

Isolation is the measure of the power level at the output connector of an unconnected RF channel as referenced to the power at the input connector. It is specified in dB below the input power level.

Self-Cutoff

The self-cutoff option disables the actuator current on completion of actuation. Either a series contact (linked to the actuator) or an IC driver circuit provides the current cutoff. This option results in minimum power consumption by the RF switch. Cutthroat is another name used in the industry for this option. Pulse latching is a term used to describe a switch without this feature.

SPDT Switch

A single-pole-double-throw, has one input and two output ports.

Switching Time

Switching time is the total interval beginning with the arrival of the leading edge of the command pulse at the switch DC input and ending with the completion of the switch transfer, including contact bounce. It consists of three parts: (1) inductive delay in the coil, (2) transfer time of the physical movement of the contacts, and (3) the bounce time of the RF contacts.

TTL Switch Driver Option

As a special option, switch drivers can be provided for both fail-safe and latching switches, which are compatible with industry-standard low-power Schottky TTL circuits.

Performance Parameters vs Frequency

Generally speaking, the RF performance of coaxial switches is frequency dependent. With increasing frequency, VSWR and insertion loss increase while isolation decreases. All data sheets specify these three parameters as “worst case” at the highest operating frequency. If the switch is to be used over a narrow frequency band, better performance can be achieved.

Actuator Current vs Temperature

The resistance of the actuator coil varies as a function of temperature. There is an inverse relationship between the operating temperature of the switch and the actuator drive current. For switches operating at 28 VDC, the approximate actuator drive current at temperature, T, can be calculated using the equation:

$$I_T = \frac{I_A}{[1 + .00385 (T-20)]}$$

Where:

- I_T = Actuator current at temperature, T
- I_A = Room temperature actuator current – see data sheet
- T = Temperature of interest in °C

Magnetic Sensitivity

An electromechanical switch can be sensitive to ferrous materials and external magnetic fields. Neighboring ferrous materials should be permitted no closer than 0.5 inches and adjacent external magnetic fields should be limited to a flux density of less than 5 Gauss.