



PART NUMBER	DESCRIPTION
CCRS-53S	Commercial Failsafe 2P3T, DC-26.5GHz
CRS-53S	Elite Failsafe 2P3T, DC-26.5GHz

The CCRS-53S/CRS-53S is a broadband, 2P3T, electromechanical coaxial switch designed to switch a microwave signal from a common input to either of two outputs. The characteristic impedance is 50 Ohms. The switches are small with the minimum spacing that is compatible with SMA connectors, and can also be used as a SPDT switch with external terminations.



ENVIRONMENTAL AND PHYSICAL CHARACTERISTICS	
Operating Temperature	
Commercial Model, CCRS-53S	-25°C to 65°C
Elite Model, CRS-53S	-55°C to 85°C
Vibration (MIL-STD-202 Method 214, Condition D, non-operating)	10 g's RMS
Shock (MIL-STD-202 Method 213, Condition D, non-operating)	500 g's
Standard Actuator Life	5,000,000 cycles
Actuator Life w/ Additional Features	1,000,000 cycles
Connector Type	SMA
Humidity (Moisture Seal)	Available
Weight	2.65 oz. (75.1g) (max.)

ELECTRICAL CHARACTERISTICS	
Form Factor	2P3T, break before make
Frequency Range	
CCRS-53S	DC-26.5 GHz
CRS-53S	DC-26.5 GHz
Characteristic Impedance	50 Ohms
Operate Time	10 ms (max.)
Release Time	10 ms (max.)
Actuation Voltage Available	12 15 24 28 V
Actuation Current, max. @ ambient	420 350 280 200 mA

TYPICAL PERFORMANCE CHARACTERISTICS					
Frequency	DC-6 GHz	6-12 GHz	12-18 GHz	18-22 GHz	22-26.5 GHz
Insertion Loss, dB, max.	0.2	0.4	0.5	0.6	0.7
Isolation, dB, min.	70	60	60	50	50
VSWR, max.	1.25:1	1.4:1	1.5:1	1.6:1	1.8:1

For maximum limits, please see charts on page 3-5

PART NUMBERING SYSTEM

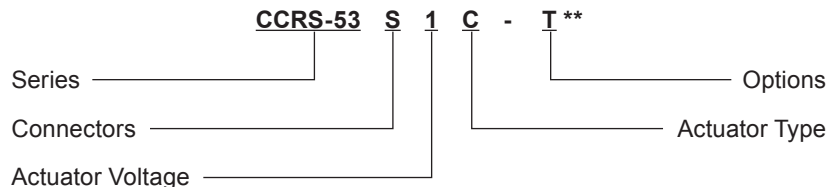

Connector
S: SMA Female

Actuator Voltage
1: 28 Vdc Failsafe
2: 15 Vdc Failsafe
3: 12 Vdc Failsafe
4: 24 Vdc Failsafe

Actuator Type
0: Standard Contacts
C: Indicator Contacts***

Options
T: TTL Drivers with Diodes
D: Transient Suppression Diodes
M: Moisture Seal
S: 9 Pin D-Sub Connector

**SEE PARTS LIST ON PAGE 8

*** Indicator Contacts Operating Temperature
-50°C to 85°C (Elite Model Only)

For other options, contact factory.

Series CCRS-53S/CRS-53S

Miniature DC-26.5 GHz
Failsafe 2P3T Coaxial Switch



SCHEMATICS AND MECHANICAL OUTLINE

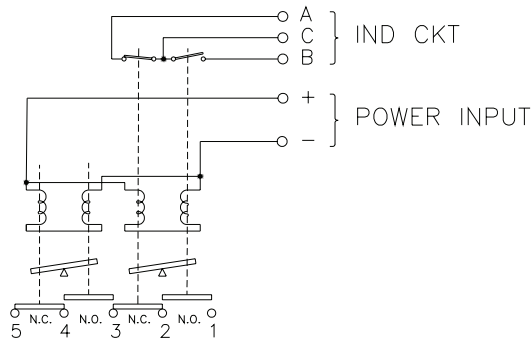

Indicators

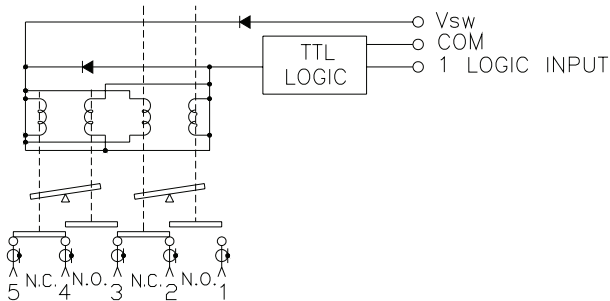
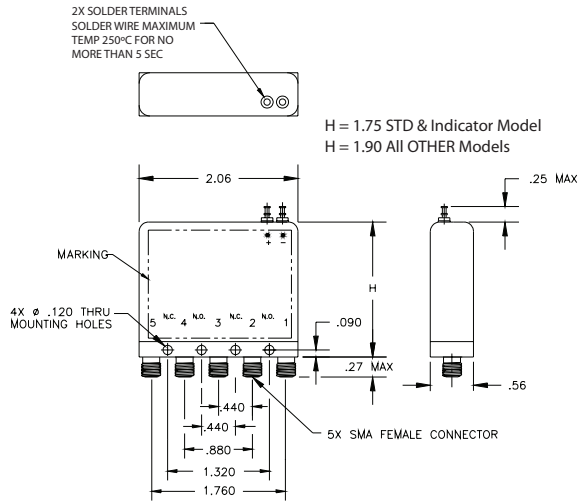

TTL

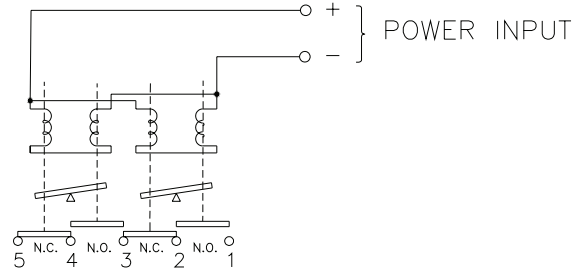

Analog

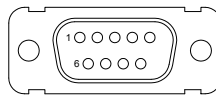

“-S OPTION” 9-PIN D-SUB CONNECTOR (EXAMPLE: CCRS-53S10-S)

Pin No.	OPTIONS			
	Basic	Indicators	TTL	Indicators & TTL
1	+	+		
2	-	-		
3			Common	Common
4			1	1
5				
6			Vsw	Vsw
7		A		A
8		B		B
9		C		C

TRUTH TABLE (with TTL option)			
Logic Input	RF Path		Indicator (if applicable)
1			
0	2&3	4&5	B & C
1	1&2	3&4	A & C

TYPICAL NARROWBAND RF INSERTION LOSS PERFORMANCE CURVES

Insertion Loss (DC-6 GHz)

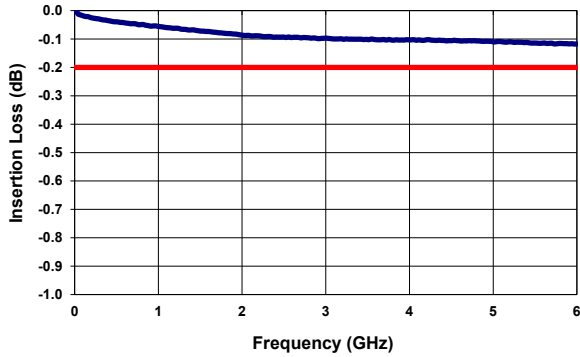

Insertion Loss (6-12 GHz)

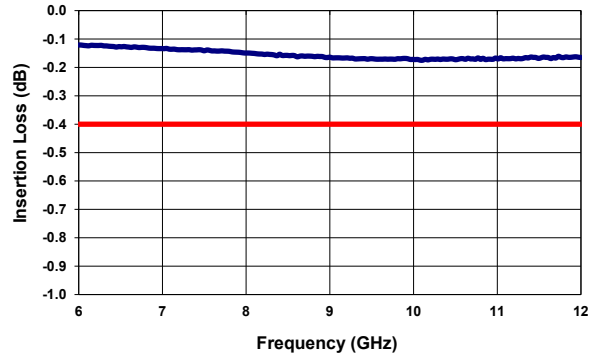

Insertion Loss (12-18 GHz)

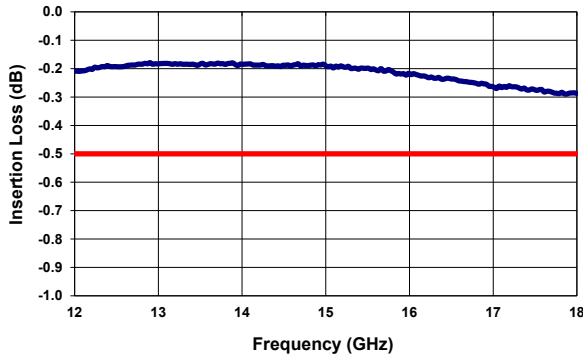

Insertion Loss (18-22 GHz)

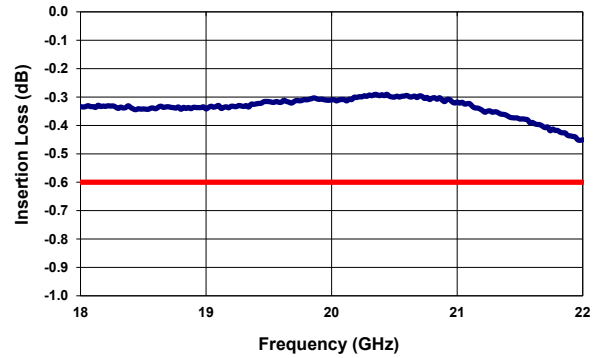

Insertion Loss (22-26.5 GHz)

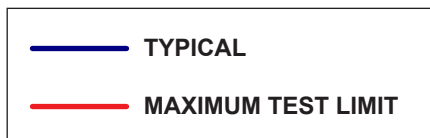
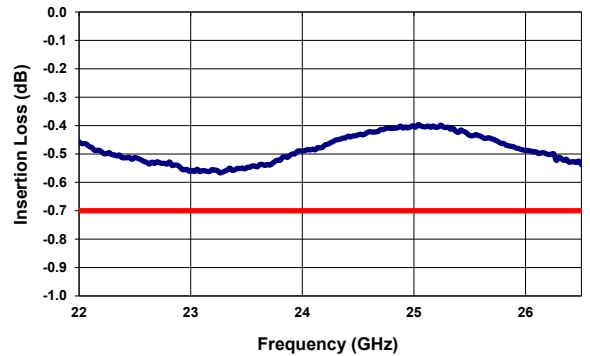

Series CCRS-53S/CRS-53S

Miniature DC–26.5 GHz

Failsafe 2P3T Coaxial Switch



TELEDYNE
COAX SWITCHES
Everywhere you look™

TYPICAL NARROWBAND RF ISOLATION PERFORMANCE CURVES

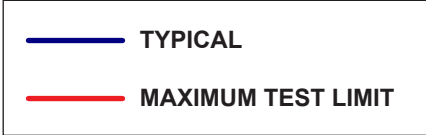
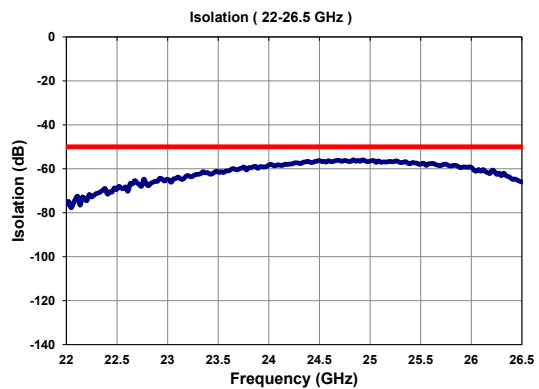
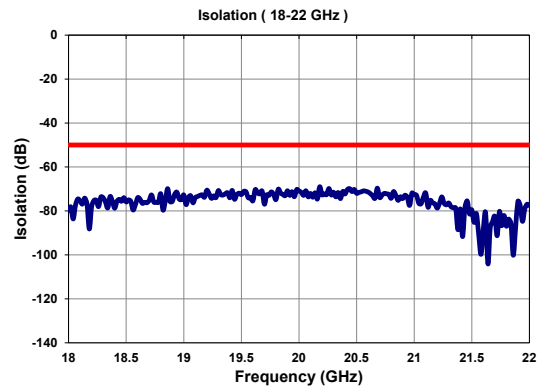
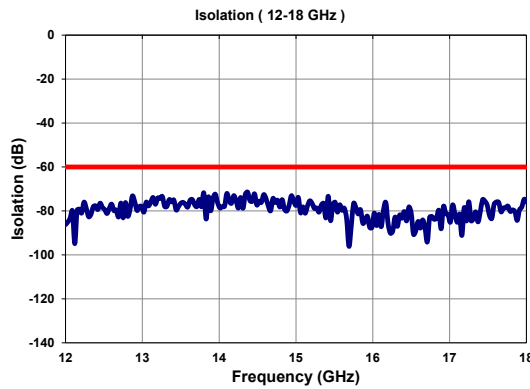
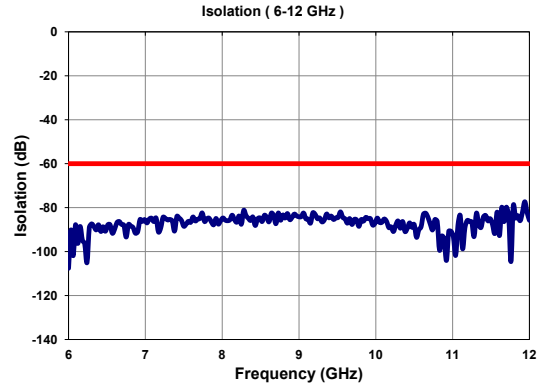
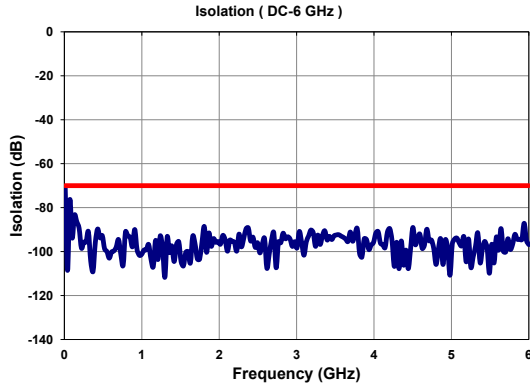

TYPICAL NARROWBAND RF VSWR PERFORMANCE CURVES

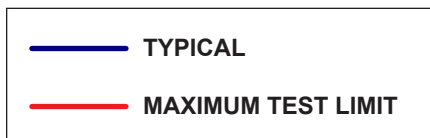
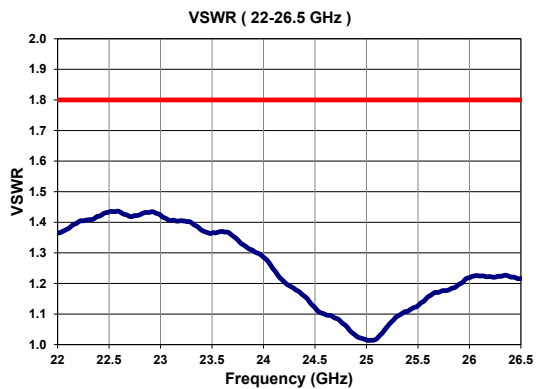
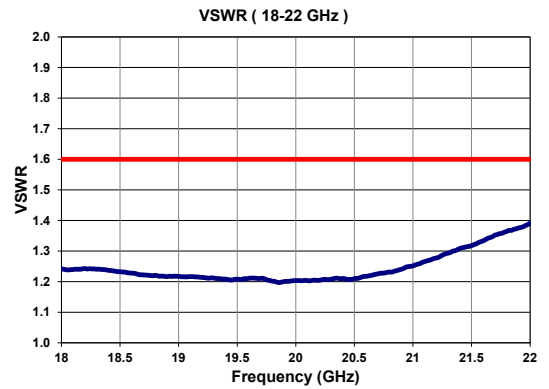
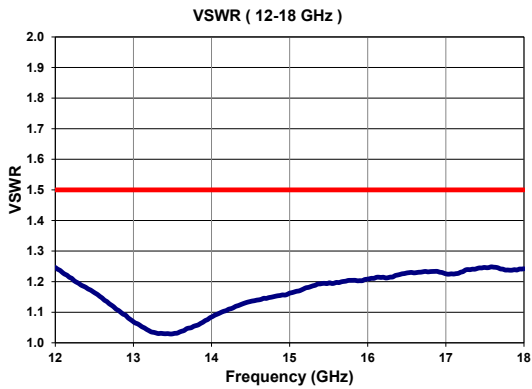
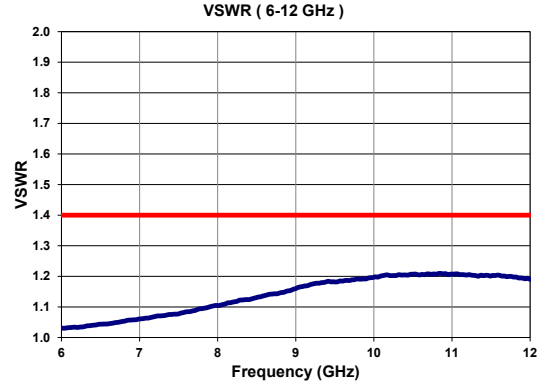
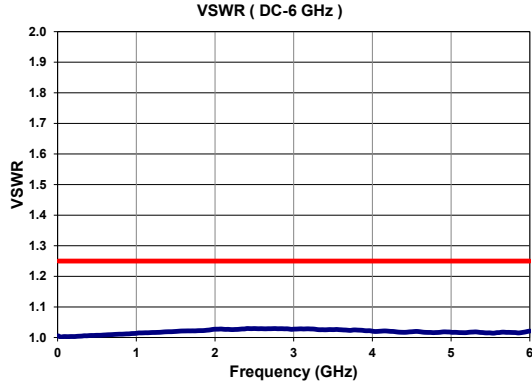



TYPICAL POWER PERFORMANCE CURVE

Power Handling vs. Frequency

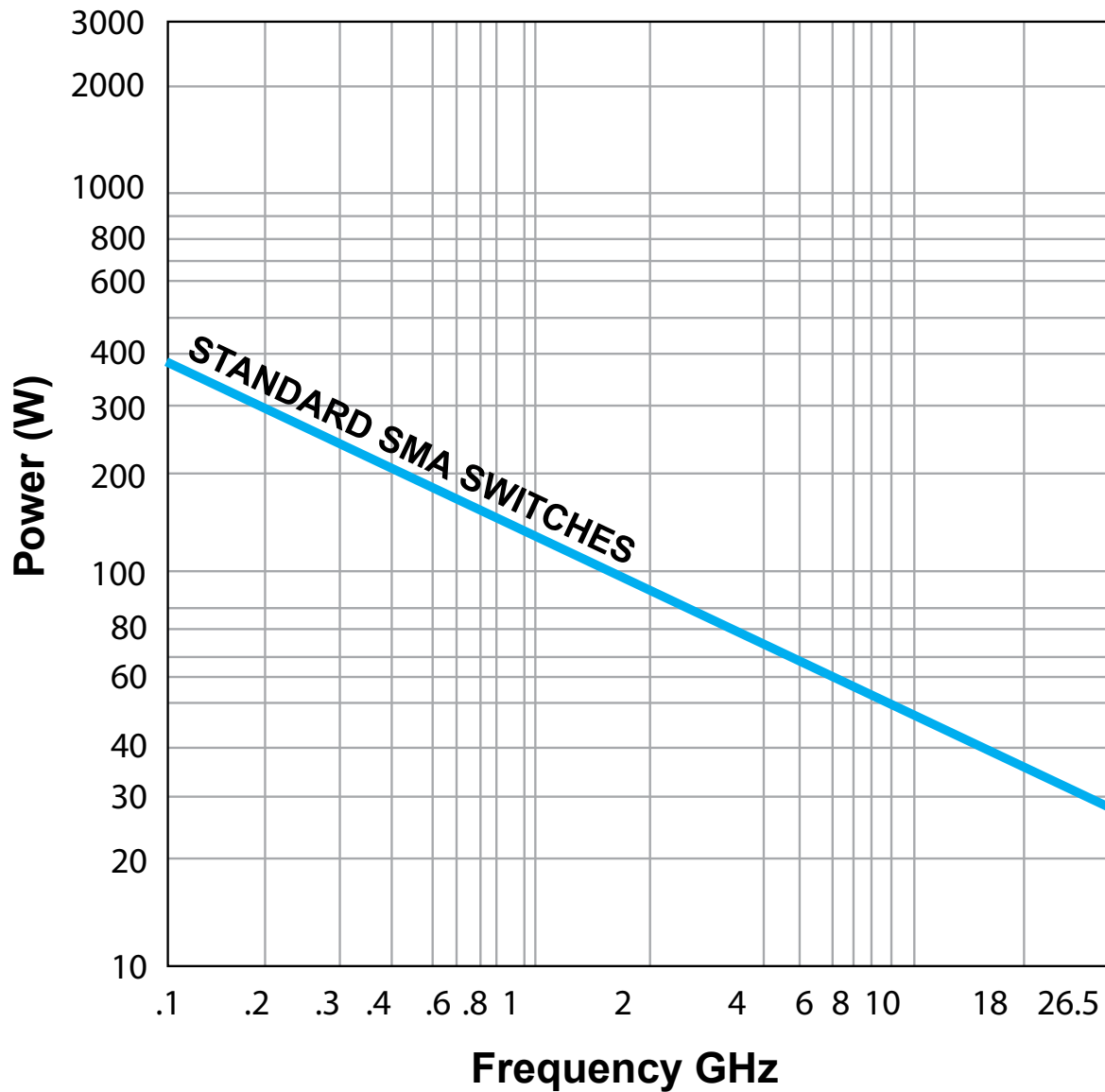

Estimates based on the following reference conditions:

- Ambient temperature of 40°C or less
- Sea level operation
- Load VSWR of 1.20:1 maximum
- No high-power (hot) switching

Please contact Teledyne Coax Switches for derating factors when applications do not meet the foregoing reference conditions.

GLOSSARY

Actuator

An actuator is the electromechanical mechanism that transfers the RF contacts from one position to another upon DC command.

Arc Suppression Diode

A diode is connected in parallel with the coil. This diode limits the “reverse EMF spike” generated when the coil de-energizes to 0.7 volts. The diode cathode is connected to the positive side of the coil and the anode is connected to the negative side.

Date Code

All switches are marked with either a unique serial number or a date code. Date codes are in accordance with MIL-STD-1285 Paragraph 5.2.5 and consist of four digits. The first two digits define the year and the last two digits define the week of the year (YYWW). Thus, 1032 identifies switches that passed through final inspection during the 32nd week of 2010.

Failsafe

A failsafe switch reverts to the default or failsafe position when actuating voltage is removed. This is realized by a return spring within the drive mechanism. This type of switch requires the continuous application of operating voltage to select and hold any position. (Multi-position switches are normally open with no voltage applied).

Indicator

Indicators tell the system which position the switch is in. Other names for indicators are telemetry contacts or tellback circuit. Indicators are usually a set of internally mounted DC contacts linked to the actuator. They can be wired to digital input lines, status lights, or interlocks. Unless otherwise specified, the maximum indicator contact rating is 30 Vdc, 50 mA, or 1.5 Watts into a resistive load.

Isolation

Isolation is the measure of the power level at the output connector of an unconnected RF channel as referenced to the power at the input connector. It is specified in dB below the input power level.

Switching Time

Switching time is the total interval beginning with the arrival of the leading edge of the command pulse at the switch DC input and ending with the completion of the switch transfer, including contact bounce. It consists of three parts: (1) inductive delay in the coil, (2) transfer time of the physical movement of the contacts, and (3) the bounce time of the RF contacts.

TTL Switch Driver Option

As a special option, switch drivers can be provided for both failsafe and latching switches, which are compatible with industry-standard low-power Schottky TTL circuits.

Performance Parameters vs Frequency

Generally speaking, the RF performance of coaxial switches is frequency dependent. With increasing frequency, VSWR and insertion loss increase while isolation decreases. All data sheets specify these three parameters as “worst case” at the highest operating frequency. If the switch is to be used over a narrow frequency band, better performance can be achieved.

Actuator Current vs Temperature

The resistance of the actuator coil varies as a function of temperature. There is an inverse relationship between the operating temperature of the switch and the actuator drive current. For switches operating at 28 VDC, the approximate actuator drive current at temperature, T, can be calculated using the equation:

$$I_T = \frac{I_A}{[1 + .00385 (T-20)]}$$

Where:

I_T = Actuator current at temperature, T

I_A = Room temperature actuator current – see data sheet

T = Temperature of interest in °C

Magnetic Sensitivity

An electro-mechanical switch can be sensitive to ferrous materials and external magnetic fields. Neighboring ferrous materials should be permitted no closer than 0.5 inches and adjacent external magnetic fields should be limited to a flux density of less than 5 Gauss.

Series CCRS-53S/CRS-53S

Miniature DC–26.5 GHz

Failsafe 2P3T Coaxial Switch



FAILSAFE CCRS-53S/CRS-53S PART NUMBER LIST

	PART No.		PART No.
1	CCRS-53SXC	43	CRS-53SX0-MS
2	CCRS-53SXC-D	44	CRS-53SX0-S
3	CCRS-53SXC-DM	45	CRS-53SX0-T
4	CCRS-53SXC-DMS	46	CRS-53SX0-TM
5	CCRS-53SXC-DS	47	CRS-53SX0-TMS
6	CCRS-53SXC-M	48	CRS-53SX0-TS
7	CCRS-53SXC-MS		
8	CCRS-53SXC-S		
9	CCRS-53SXC-T		
10	CCRS-53SXC-TM		
11	CCRS-53SXC-TMS		
12	CCRS-53SXC-TS		
13	CCRS-53SX0		
14	CCRS-53SX0-D		
15	CCRS-53SX0-DM		
16	CCRS-53SX0-DMS		
17	CCRS-53SX0-DS		
18	CCRS-53SX0-M		
19	CCRS-53SX0-MS		
20	CCRS-53SX0-S		
21	CCRS-53SX0-T		
22	CCRS-53SX0-TM		
23	CCRS-53SX0-TMS		
24	CCRS-53SX0-TS		
25	CRS-53SXC		
26	CRS-53SXC-D		
27	CRS-53SXC-DM		
28	CRS-53SXC-DMS		
29	CRS-53SXC-DS		
30	CRS-53SXC-M		
31	CRS-53SXC-MS		
32	CRS-53SXC-S		
33	CRS-53SXC-T		
34	CRS-53SXC-TM		
35	CRS-53SXC-TMS		
36	CRS-53SXC-TS		
37	CRS-53SX0		
38	CRS-53SX0-D		
39	CRS-53SX0-DM		
40	CRS-53SX0-DMS		
41	CRS-53SX0-DS		
42	CRS-53SX0-M		

* X = 1 (28Vdc), 2 (15Vdc), 3 (12Vdc) and 4 (24Vdc)