



PART NUMBER	DESCRIPTION
CCR-59S	Commercial Latching Multi-throw, DC-18 GHz
<p>The CCR-59S is a broadband, multi-throw, electromechanical coaxial switch designed to switch a microwave signal from a common input to any of 7 or 8 outputs. The characteristic impedance is 50 Ohms. Each position has an individual actuator mechanism allowing random position selection. This also minimizes switching time.</p> <p>The CCR-59S comes with a latching actuator. The latching switch remains in the last position selected when the switch is de-energized. STD dual command requires a reset pulse before a new selected position. A separate reset circuit allows all positions to be set to an open position. User must provide both reset (clear) and set (select new position) commands</p>	



ENVIRONMENTAL AND PHYSICAL CHARACTERISTICS	
Operating Temperature	
Commercial Model, CCR-38S	-25°C to 65°C
Elite Model, CR-38S	-55°C to 85°C
Vibration (MIL-STD-202 Method 214, Condition D, non-operating)	10 g's RMS
Shock (MIL-STD-202 Method 213, Condition D, non-operating)	500 g's
Standard Actuator Life	3,000,000 cycles
Actuator Life w/ Additional Features	1,000,000 cycles
Connector Type	SMA
Humidity (Moisture Seal)	Available
Weight	9 oz. (255.2G) (max.)

ELECTRICAL CHARACTERISTICS	
Form Factor	Multi-Throw, break before make
Frequency Range	DC–12 GHz
Characteristic Impedance	50 Ohms
Operate Time	20 ms (max.)
Release Time	20 ms (max.)
Actuation Voltage Available	12 15 24 28 V
Actuation Current, max. Select	150 105 90 105 mA
SP7T Reset	1090 735 630 735 mA
SP8T Reset	1200 840 720 840 mA

RF SPECIFICATIONS				
Frequency	DC–6 GHz	6–12 GHz	12–18 GHz	
Insertion Loss, dB, max.	0.20	0.40	0.60	
Isolation, dB, min.	70	60	60	
VSWR , max.	1.30:1	1.40:1	1.70:1	

PART NUMBERING SYSTEM

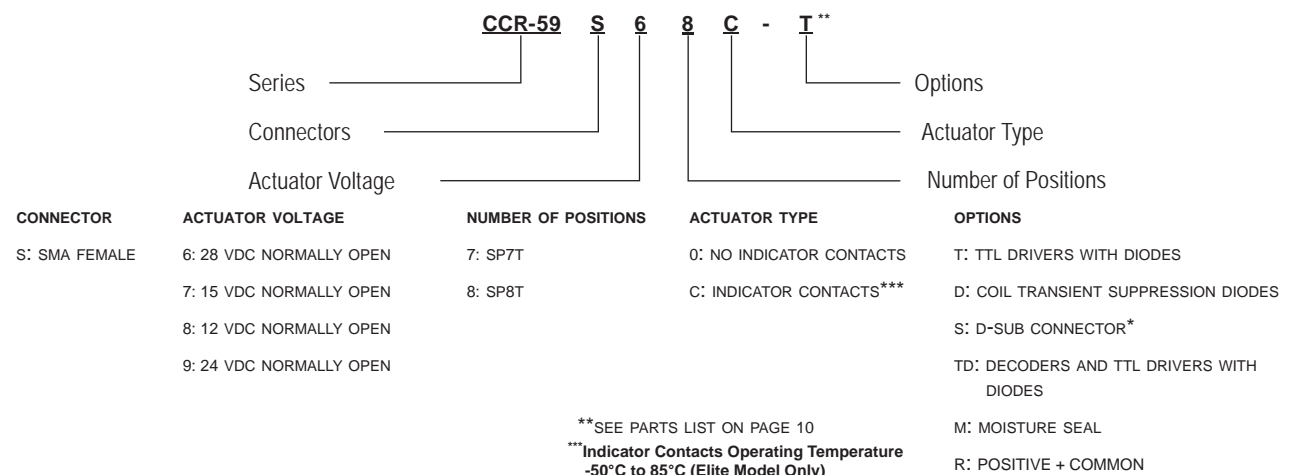

For additional options, please contact factory.

* D-Sub Connector may be 15 or 25 pin depending on number of throws. (See Connector Pinout page)

SCHEMATICS AND MECHANICAL OUTLINE

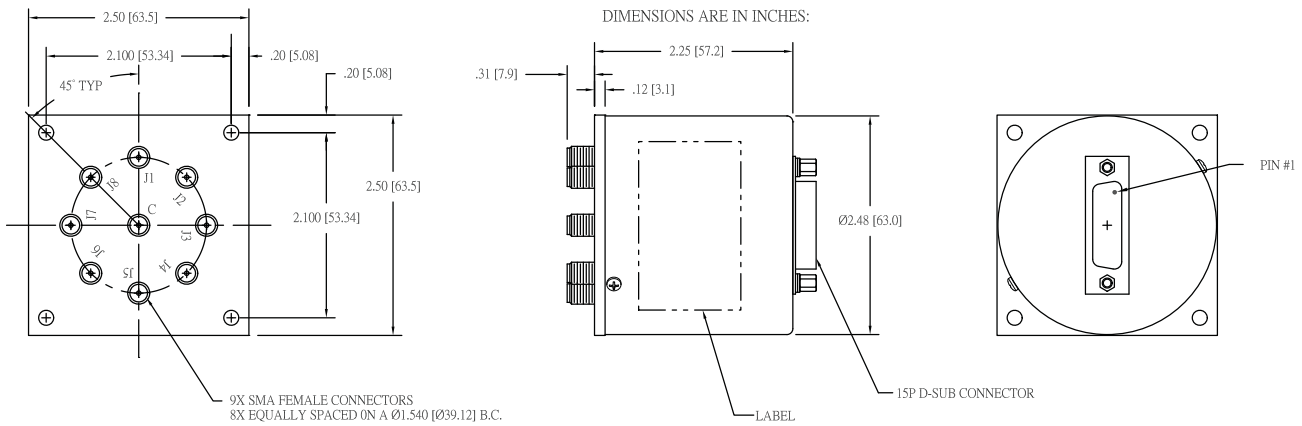
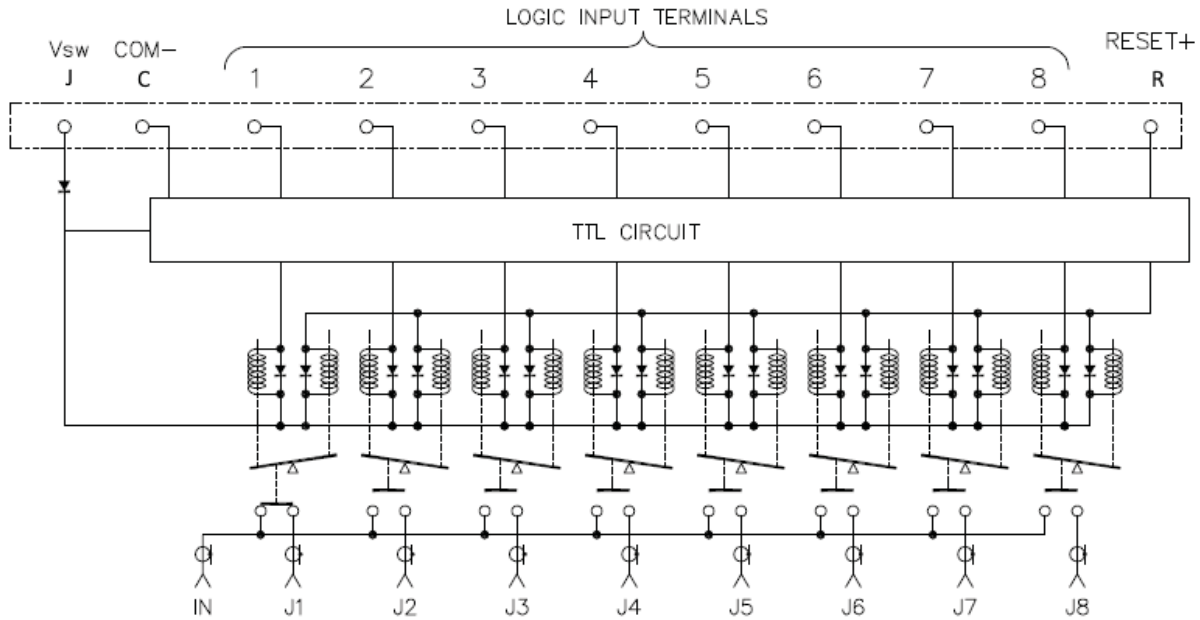

“-S OPTION” 15-PIN D-SUB OR 25-PIN D-MICRO CONNECTOR (EXAMPLE: CCR-59S680-S)

CONNECTOR PINOUT FOR LATCHING SP7T MULTI-THROW SWITCHES						
EXAMPLE	CCR-59S670-S	CCR-59S67C-S	CCR-59S670-TS	CCR-59S67C-TS	CCR-59S670-TDS	CCR-59S67C-TDS
INDICATOR		Yes		Yes		Yes
TTL			Yes	Yes		
DECODERS & TTL					Yes	Yes
PIN NO.	15-PIN	26-PIN	15-PIN	26-PIN	15-PIN	26-PIN
1	PORT 1	PORT 1	TTL 1	TTL 1	LOGIC 1	LOGIC 1
2	PORT 2	PORT 2	TTL 2	TTL 2	LOGIC 2	LOGIC 2
3	PORT 3	PORT 3	TTL 3	TTL 3	LOGIC 3	LOGIC 3
4	PORT 4	PORT 4	TTL 4	TTL 4		
5	PORT 5	PORT 5	TTL 5	TTL 5		
6	PORT 6	PORT 6	TTL 6	TTL 6		
7	PORT 7	PORT 7	TTL 7	TTL 7		
8						
9						
10						
11			Vsw	Vsw	Vsw	Vsw
12	Reset	Reset	Reset	Reset		
13	COMMON	COMMON	COMMON	COMMON	COMMON	COMMON
14		D Indicator (COM)		D Indicator (COM)		D Indicator (COM)
15		E Indicator		E Indicator		E Indicator
16		F Indicator		F Indicator		F Indicator
17		G Indicator		G Indicator		G Indicator
18		H Indicator		H Indicator		H Indicator
19		K Indicator		K Indicator		K Indicator
20		L Indicator		L Indicator		L Indicator
21		M Indicator		M Indicator		M Indicator
22						
23						
24						
25						
26						

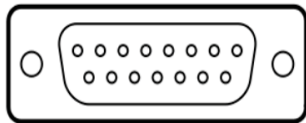

15-PIN D-SUB CONNECTOR

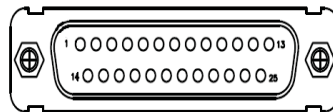

25-PIN D-SUB CONNECTOR

Series CCR-59S
Multi-Throw DC-18 GHz, SP7T & SP8T
Latching Coaxial Switch



SP7T TRUTH TABLE Latching
CCR-59SX7C-T

Logic Input								RF Path								Indicator Switches						
1	2	3	4	5	6	7	R	J1	J2	J3	J4	J5	J6	J7	Reset	E	F	G	H	K	L	M
1	0	0	0	0	0	0	0	On	Off	Off	Off	Off	Off	Off	Off	C	0	0	0	0	0	0
0	1	0	0	0	0	0	0	Off	On	Off	Off	Off	Off	Off	Off	0	C	0	0	0	0	0
0	0	1	0	0	0	0	0	Off	Off	On	Off	Off	Off	Off	Off	0	0	C	0	0	0	0
0	0	0	1	0	0	0	0	Off	Off	Off	On	Off	Off	Off	Off	0	0	0	C	0	0	0
0	0	0	0	1	0	0	0	Off	Off	Off	Off	On	Off	Off	Off	0	0	0	0	C	0	0
0	0	0	0	0	1	0	0	Off	Off	Off	Off	Off	On	Off	Off	0	0	0	0	0	C	0
0	0	0	0	0	0	1	0	Off	Off	Off	Off	Off	Off	On	Off	0	0	0	0	0	0	C

TRUTH TABLE Latching
CCR-59SX7C-TD

Logic Input				RF Path								Indicator Switches						
1	2	3	4	J1	J2	J3	J4	J5	J6	J7	Reset	E	F	G	H	K	L	M
0	0	0	0	On	Off	Off	Off	Off	Off	Off	Off	C	0	0	0	0	0	0
1	0	0	0	Off	On	Off	Off	Off	Off	Off	Off	0	C	0	0	0	0	0
0	1	0	0	Off	Off	On	Off	Off	Off	Off	Off	0	0	C	0	0	0	0
1	1	0	0	Off	Off	Off	On	Off	Off	Off	Off	0	0	0	C	0	0	0
0	0	1	0	Off	Off	Off	Off	On	Off	Off	Off	0	0	0	0	C	0	0
1	0	1	0	Off	Off	Off	Off	Off	On	Off	Off	0	0	0	0	0	C	0
0	1	1	0	Off	Off	Off	Off	Off	Off	On	Off	0	0	0	0	0	0	C
1	1	1	0	Off	Off	Off	Off	Off	Off	Off	Reset	0	0	0	0	0	0	0
1	1	1	1	COIL OFF								0	0	0	0	0	0	0

CONNECTOR PINOUT FOR LATCHING SP8T MULTI-THROW SWITCHES						
EXAMPLE	CCR-59S680-S	CCR-59S68C-S	CCR-59S680-TS	CCR-59S68C-TS	CCR-59S680-TDS	CCR-59S68C-TDS
INDICATOR		Yes		Yes		Yes
TTL			Yes	Yes		
DECODERS & TTL					Yes	Yes
PIN NO.	15-PIN	26-PIN	15-PIN	26-PIN	15-PIN	26-PIN
1	PORT 1	PORT 1	TTL 1	TTL 1	LOGIC 1	LOGIC 1
2	PORT 2	PORT 2	TTL 2	TTL 2	LOGIC 2	LOGIC 2
3	PORT 3	PORT 3	TTL 3	TTL 3	LOGIC 3	LOGIC 3
4	PORT 4	PORT 4	TTL 4	TTL 4	LOGIC 4	LOGIC 4
5	PORT 5	PORT 5	TTL 5	TTL 5		
6	PORT 6	PORT 6	TTL 6	TTL 6		
7	PORT 7	PORT 7	TTL 7	TTL 7		
8	PORT 8	PORT 8	TTL 8	TTL 8		
9						
10						
11			Vsw	Vsw	Vsw	Vsw
12	Reset	Reset	Reset	Reset		
13	Common	Common	Common	Common	Common	Common
14		D Indicator (COM)		D Indicator (COM)		D Indicator (COM)
15		E Indicator		E Indicator		E Indicator
16		F Indicator		F Indicator		F Indicator
17		G Indicator		G Indicator		G Indicator
18		H Indicator		H Indicator		H Indicator
19		K Indicator		K Indicator		K Indicator
20		L Indicator		L Indicator		L Indicator
21		M Indicator		M Indicator		M Indicator
22		N Indicator		N Indicator		N Indicator
23						
24						
25						
26						

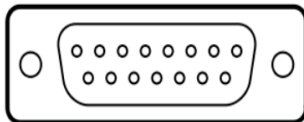

15-PIN D-SUB CONNECTOR

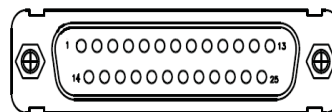

25-PIN D-SUB CONNECTOR

Series CCR-59S
Multi-Throw DC–18 GHz, SP7T & SP8T
Latching Coaxial Switch



SP8T TRUTH TABLE Latching
CCR-59SX8C-T

Logic Input									RF Path									Indicator Switches							
1	2	3	4	5	6	7	8	R	J1	J2	J3	J4	J5	J6	J7	J8	Reset	E	F	G	H	K	L	M	N
1	0	0	0	0	0	0	0	0	On	Off	Off	Off	Off	Off	Off	Off	Off	C	0	0	0	0	0	0	0
0	1	0	0	0	0	0	0	0	Off	On	Off	Off	Off	Off	Off	Off	Off	0	C	0	0	0	0	0	0
0	0	1	0	0	0	0	0	0	Off	Off	On	Off	Off	Off	Off	Off	Off	0	0	C	0	0	0	0	0
0	0	0	1	0	0	0	0	0	Off	Off	Off	On	Off	Off	Off	Off	Off	0	0	0	C	0	0	0	0
0	0	0	0	1	0	0	0	0	Off	Off	Off	Off	On	Off	Off	Off	Off	0	0	0	0	C	0	0	0
0	0	0	0	0	1	0	0	0	Off	Off	Off	Off	Off	On	Off	Off	Off	0	0	0	0	0	C	0	0
0	0	0	0	0	0	1	0	0	Off	Off	Off	Off	Off	Off	On	Off	Off	0	0	0	0	0	0	C	0
0	0	0	0	0	0	0	1	0	Off	Off	Off	Off	Off	Off	Off	On	Off	0	0	0	0	0	0	0	C
0	0	0	0	0	0	0	0	1	Off	Off	Off	Off	Off	Off	Off	On	Off	0	0	0	0	0	0	0	C

TRUTH TABLE Latching
CCR-59SX8C-TD

Logic Input				RF Path								Indicator Switches								
1	2	3	4	J1	J2	J3	J4	J5	J6	J7	J8	Reset	E	F	G	H	K	L	M	N
0	0	0	0	On	Off	Off	Off	Off	Off	Off	Off	Off	C	0	0	0	0	0	0	0
1	0	0	0	Off	On	Off	Off	Off	Off	Off	Off	Off	0	C	0	0	0	0	0	0
0	1	0	0	Off	Off	On	Off	Off	Off	Off	Off	Off	0	0	C	0	0	0	0	0
1	1	0	0	Off	Off	Off	On	Off	Off	Off	Off	Off	0	0	0	C	0	0	0	0
0	0	1	0	Off	Off	Off	Off	On	Off	Off	Off	Off	0	0	0	0	C	0	0	0
1	0	1	0	Off	Off	Off	Off	Off	On	Off	Off	Off	0	0	0	0	0	C	0	0
0	1	1	0	Off	Off	Off	Off	Off	Off	On	Off	Off	0	0	0	0	0	0	C	0
1	1	1	0	Off	Off	Off	Off	Off	Off	Off	On	Off	0	0	0	0	0	0	0	C
0	0	0	1	Off	Off	Off	Off	Off	Off	Off	Off	Reset	0	0	0	0	0	0	0	0
1	1	1	1	COIL OFF								0	0	0	0	0	0	0	0	

TYPICAL RF PERFORMANCE CURVES

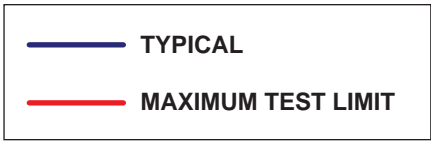
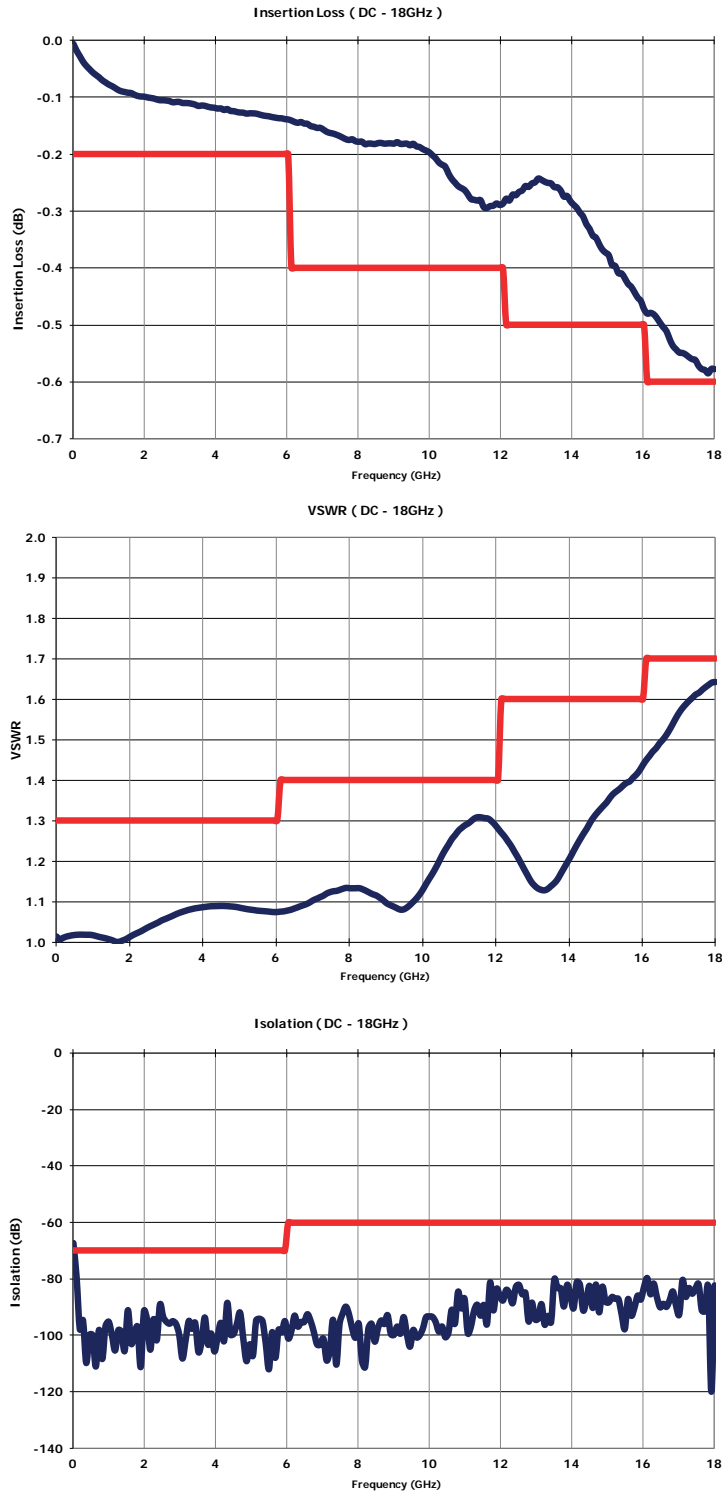

TYPICAL POWER PERFORMANCE CURVE

Power Handling vs. Frequency

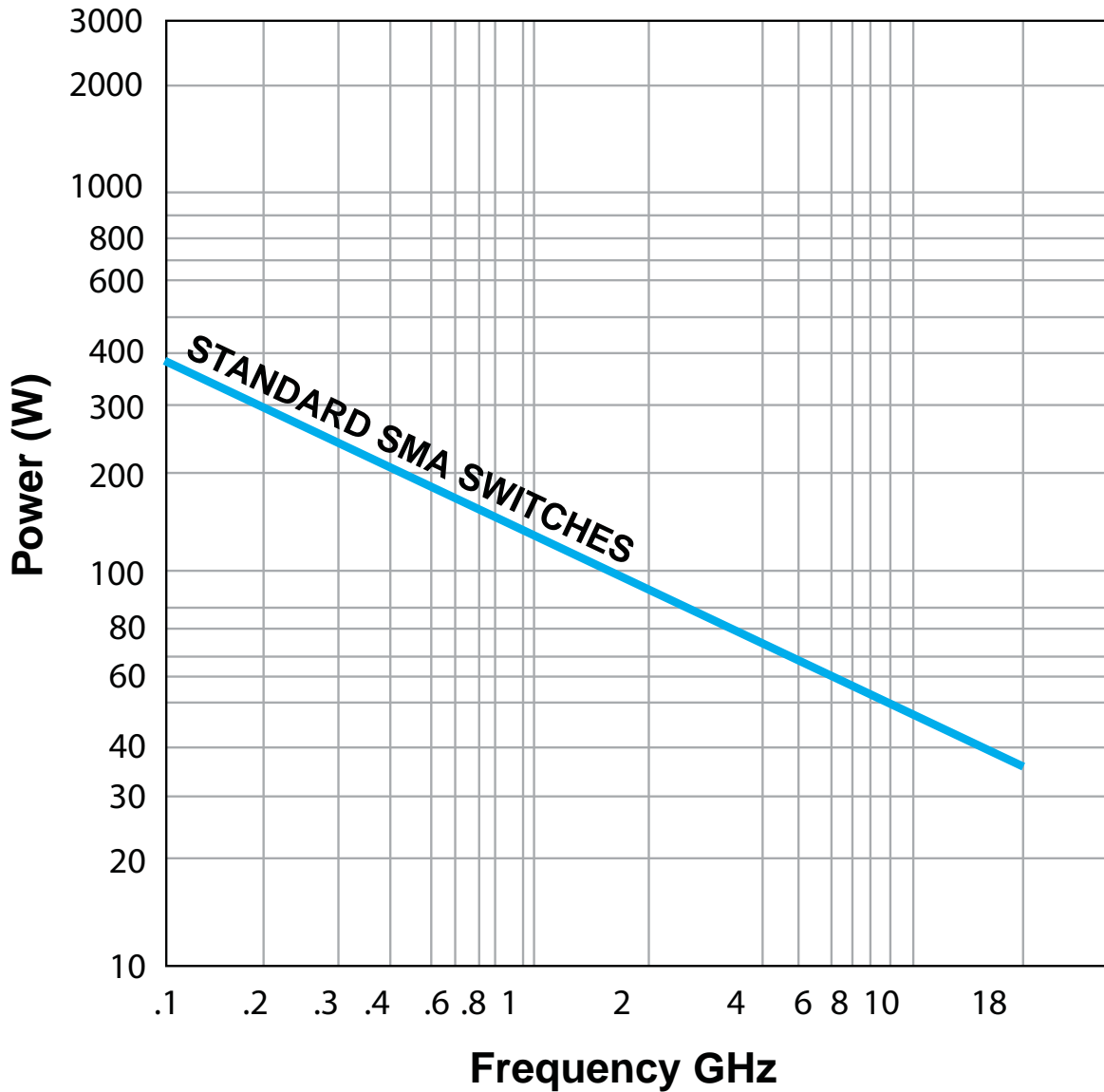

Estimates based on the following reference conditions:

- Ambient temperature of 40°C or less
- Sea level operation
- Load VSWR of 1.20:1 maximum
- No high-power (hot) switching

Please contact Teledyne Coax Switches for derating factors when applications do not meet the foregoing reference conditions.

GLOSSARY

Actuator

An actuator is the electromechanical mechanism that transfers the RF contacts from one position to another upon DC command.

Arc Suppression Diode

A diode is connected in parallel with the coil. This diode limits the “reverse EMF spike” generated when the coil de-energizes to 0.7 volts. The diode cathode is connected to the positive side of the coil and the anode is connected to the negative side.

Date Code

All switches are marked with either a unique serial number or a date code. Date codes are in accordance with MIL-STD-1285 Paragraph 5.2.5 and consist of four digits. The first two digits define the year and the last two digits define the week of the year (YYWW). Thus, 1032 identifies switches that passed through final inspection during the 32nd week of 2010.

Indicator

Indicators tell the system which position the switch is in. Other names for indicators are telemetry contacts or tellback circuit. Indicators are usually a set of internally mounted DC contacts linked to the actuator. They can be wired to digital input lines, status lights, or interlocks. Unless otherwise specified, the maximum indicator contact rating is 30 Vdc, 50 mA, or 1.5 Watts into a resistive load.

Isolation

Isolation is the measure of the power level at the output connector of an unconnected RF channel as referenced to the power at the input connector. It is specified in dB below the input power level.

Multi-Throw Latching Switch

A multi-throw switch is a switch with one input and three or more output ports. The CCR-59 can switch a microwave signal to any of 8 outputs from a single common input.

Switching Time

Switching time is the total interval beginning with the arrival of the leading edge of the command pulse at the switch DC input and ending with the completion of the switch transfer, including contact bounce. It consists of three parts: (1) inductive delay in the coil, (2) transfer time of the physical movement of the contacts, and (3) the bounce time of the RF contacts.

TTL Switch Driver Option

As a special option, switch drivers can be provided for both failsafe and latching switches, which are compatible with industry-standard low-power Schottky TTL circuits.

TD-Option

This option includes a decoder. The 4-bit parallel command is decoded to internally select the appropriate position. See the logic tables. The TD-Option increases the Vsw supply current demand by 50mA max at 28Vdc and +20°C.

Performance Parameters vs Frequency

Generally speaking, the RF performance of coaxial switches is frequency dependent. With increasing frequency, VSWR and insertion loss increase while isolation decreases. All data sheets specify these three parameters as “worst case” at the highest operating frequency. If the switch is to be used over a narrow frequency band, better performance can be achieved.

Actuator Current vs Temperature

The resistance of the actuator coil varies as a function of temperature. There is an inverse relationship between the operating temperature of the switch and the actuator drive current. For switches operating at 28 VDC, the approximate actuator drive current at temperature, T , can be calculated using the equation:

$$I_T = \frac{I_A}{[1 + .00385 (T-20)]}$$

Where:

I_T = Actuator current at temperature, T

I_A = Room temperature actuator current – see data sheet

T = Temperature of interest in °C

Magnetic Sensitivity

An electro-mechanical switch can be sensitive to ferrous materials and external magnetic fields. Neighboring ferrous materials should be permitted no closer than 0.5 inches and adjacent external magnetic fields should be limited to a flux density of less than 5 Gauss.

SPECIAL FEATURE

Switching High-Power or Highly Sensitive Signals

Ensure the most linear response with the best galvanically matched contact system in the industry. Extremely low passive intermodulation is standard on all of our switches.

Carrier Frequency 1	Carrier Frequency 2	PIM 3rd Order Frequency	PIM 5th Order Frequency
870 MHz	893 MHz	847 MHz	824 MHz

	3rd Order Intermodulation	5th Order Intermodulation
Multiple Positions	–96 dBm	–115 dBm
	–139 dBc	–158 dBc

Series CCR-59S

Multi-Throw DC–18 GHz, SP7T & SP8T
Latching Coaxial Switch



NORMALLY OPEN CCR-38S PART NUMBER LIST

	PART No.		PART No.		PART No.		PART No.
1	CCR-59SX7C	43	CCR-59SX70-TMS	85	CCR-59SX8C-MS	127	CCR-59SX8D-RS
2	CCR-59SX7C-D	44	CCR-59SX70-TS	86	CCR-59SX8C-R	128	CCR-59SX8D-S
3	CCR-59SX7C-DM	45	CCR-59SX7D	87	CCR-59SX8C-RM	129	CCR-59SX8D-T
4	CCR-59SX7C-DR	46	CCR-59SX7D-M	88	CCR-59SX8C-RMS	130	CCR-59SX8D-TD
5	CCR-59SX7C-DRM	47	CCR-59SX7D-MS	89	CCR-59SX8C-RS	131	CCR-59SX8D-TDM
6	CCR-59SX7C-DRS	48	CCR-59SX7D-R	90	CCR-59SX8C-S	132	CCR-59SX8D-TDMS
7	CCR-59SX7C-DS	49	CCR-59SX7D-RM	91	CCR-59SX8C-T	133	CCR-59SX8D-TDS
8	CCR-59SX7C-M	50	CCR-59SX7D-RMS	92	CCR-59SX8C-TD	134	CCR-59SX8D-TM
9	CCR-59SX7C-MS	51	CCR-59SX7D-RS	93	CCR-59SX8C-TDM	135	CCR-59SX8D-TMS
10	CCR-59SX7C-R	52	CCR-59SX7D-S	94	CCR-59SX8C-TDMS	136	CCR-59SX8D-TS
11	CCR-59SX7C-RM	53	CCR-59SX7D-T	95	CCR-59SX8C-TDS	137	CCR-59SX8E
12	CCR-59SX7C-RMS	54	CCR-59SX7D-TD	96	CCR-59SX8C-TM	138	CCR-59SX8E-M
13	CCR-59SX7C-RS	55	CCR-59SX7D-TDM	97	CCR-59SX8C-TMS	139	CCR-59SX8E-MS
14	CCR-59SX7C-S	56	CCR-59SX7D-TDMS	98	CCR-59SX8C-TS	140	CCR-59SX8E-R
15	CCR-59SX7C-T	57	CCR-59SX7D-TDS	99	CCR-59SX80	141	CCR-59SX8E-RM
16	CCR-59SX7C-TD	58	CCR-59SX7D-TM	100	CCR-59SX80-D	142	CCR-59SX8E-RMS
17	CCR-59SX7C-TDM	39	CCR-59SX7D-TMS	101	CCR-59SX80-DM	143	CCR-59SX8E-RS
18	CCR-59SX7C-TDMS	60	CCR-59SX7D-TS	102	CCR-59SX80-DR	144	CCR-59SX8E-S
19	CCR-59SX7C-TDS	61	CCR-59SX7E	103	CCR-59SX80-DRM	145	CCR-59SX8E-T
20	CCR-59SX7C-TM	62	CCR-59SX7E-M	104	CCR-59SX80-DRS	146	CCR-59SX8E-TD
21	CCR-59SX7C-TMS	63	CCR-59SX7E-MS	105	CCR-59SX80-DS	147	CCR-59SX8E-TDM
22	CCR-59SX7C-TS	64	CCR-59SX7E-R	106	CCR-59SX80-M	148	CCR-59SX8E-TDMS
23	CCR-59SX70	65	CCR-59SX7E-RM	107	CCR-59SX80-MS	149	CCR-59SX8E-TDS
24	CCR-59SX70-D	66	CCR-59SX7E-RMS	108	CCR-59SX80-R	150	CCR-59SX8E-TM
25	CCR-59SX70-DM	67	CCR-59SX7E-RS	109	CCR-59SX80-RM	151	CCR-59SX8E-TMS
26	CCR-59SX70-DR	68	CCR-59SX7E-S	110	CCR-59SX80-RMS	152	CCR-59SX8E-TS
27	CCR-59SX70-DRM	69	CCR-59SX7E-T	111	CCR-59SX80-RS		
28	CCR-59SX70-DRS	70	CCR-59SX7E-TD	112	CCR-59SX80-S		
29	CCR-59SX70-DS	71	CCR-59SX7E-TDM	113	CCR-59SX80-T		
30	CCR-59SX70-M	72	CCR-59SX7E-TDMS	114	CCR-59SX80-TD		
31	CCR-59SX70-MS	73	CCR-59SX7E-TDS	115	CCR-59SX80-TDM		
32	CCR-59SX70-R	74	CCR-59SX7E-TM	116	CCR-59SX80-TDMS		
33	CCR-59SX70-RM	75	CCR-59SX7E-TMS	117	CCR-59SX80-TDS		
34	CCR-59SX70-RMS	76	CCR-59SX7E-TS	118	CCR-59SX80-TM		
35	CCR-59SX70-RS	77	CCR-59SX8C	119	CCR-59SX80-TMS		
36	CCR-59SX70-S	78	CCR-59SX8C-D	120	CCR-59SX80-TS		
37	CCR-59SX70-T	79	CCR-59SX8C-DM	121	CCR-59SX8D		
38	CCR-59SX70-TD	80	CCR-59SX8C-DR	122	CCR-59SX8D-M		
39	CCR-59SX70-TDM	81	CCR-59SX8C-DRM	123	CCR-59SX8D-MS		
40	CCR-59SX70-TDMS	82	CCR-59SX8C-DRS	124	CCR-59SX8D-R		
41	CCR-59SX70-TDS	83	CCR-59SX8C-DS	125	CCR-59SX8D-RM		
42	CCR-59SX70-TM	84	CCR-59SX8C-M	126	CCR-59SX8D-RMS		

* X = 6 (28Vdc), 7 (15Vdc), 8 (12Vdc) and 9 (24Vdc)