

Industrial Solid-State Relays Selection Guide



Dual Output



Single Phase



Three Phase



PCB Mount



DIN-Rail

Quad Output

Motor Controllers

AC or DC



**TELEDYNE
RELAYS**
Everywhereyoulook™



RoHS or Non-RoHS:
Your Choice!

SOLID STATE RELAYS

The advantages Industrial Solid State Relays (ISSR) compared to Electromechanical Relays (EMR) are well known. ISSRs are fully electronic, with no moving parts inside; no audible noise, able to withstand significant vibration without operational issues, fast response time, but most important of all higher life-time expectancy.

Used in optimal operating conditions, ISSRs have nearly unlimited life compared to EMRs, it also does not require any maintenance and prevents production downtime, which is a great advantage when continuous operation is necessary.



MAIN APPLICATIONS

HEATING

Plastic injection molding
Furnaces
Power supply distribution
Air conditioning
Textile
Home heating
Infrared heating
Drying
Thermoforming

MOTOR STARTING

Pumps
Compressor
Plastic injection molding
Conveyors
Fans

LIGHTING

Public lighting
Cinema
Theatre lamps
Airport runway lamps
Road lighting

CONTROL

PLC interface
Heating element control
Solenoid valves
Contractor coils
Optocoupling of sensors

MISCELLANEOUS

Transformer starting
Power factor corrector
Uninterrupted power supply
Energy source switching
Capacitors control

SWITCHING SOLUTIONS

Teledyne Relays has been providing industrial power solid-state relays for over 50 years. The company offers a broad range of products, from standard off-the-shelf single-, dual-, three- and quad-output relays to custom products with diagnostics and phase monitoring. These relays are used in numerous applications, including food equipment, heating, lighting, medical equipment, motor control, refrigeration, temp control and mil-aero applications. Teledyne's selection of high-quality components results in reduced EMI and lower start-up surges. The rugged design, including the direct-bond copper (DBC) and wirebond assembly, offers the most reliable and thermally efficient product on the market. Teledyne is also the world's innovative leader in manufacturing hermetically sealed solid-state and electromechanical relays. Teledyne Relays' industrial SSRs, mil-aero SSRs, electromechanical relays and coaxial switches offer switching solutions across a wide range of markets and applications.

Product Assurance

Under an aggressive Total Quality Management (TQM) program, Teledyne Relays has embraced a "continuous improvement" culture. With recognized certifications such as Boeing D6-82479, MIL-STD-790, AS/EN/JISQ9100:2009 (Rev C) and ISO 9001:2008, Teledyne Relays has become a primary supplier of switching solutions with the highest quality and reliability to industry leaders around the world.

CONTENTS

InP1012

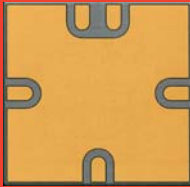

- Greater than 40Gbps bandwidth
- Frequency range, DC to 60GHz
- Small form factor, 3mm X 3mm X 1mm
- High isolation
- Low insertion loss
- Switching time of less than 100ns

See Page 16



RF121 / GRF121



- Broader bandwidth (DC - 18GHz)
- Signal integrity up to 40Gbps
- SPDT, Magnetic Latching
- Metal Enclosure for EMI shielding
- High Repeatability
- 3 Million Cycle Life

See Page 17

SINGLE PHASE AC RELAYS

SH AC	1
STH	2
S	2
ST	3
FS	3
G	3
SHP	4
DH	4
DRS	4
L	4
LS	5
BS	5
AS4	5

DUAL OUTPUT AC RELAYS

SD	6
----------	---

THREE PHASE AC RELAYS

E3P	8
E3PT	8
C3P	8
S3P	9

QUAD OUTPUT AC RELAYS

SQ	9
----------	---

DC SOLID STATE RELAYS

S20	10
SH DC	10
LS10	11
PS	11
DS	12
DX	12
SI	13
SHI	13

MOTOR CONTROLLERS

EMCRT	14
EMC	14

PROTECTION MODULE

PR	14
----------	----

ACCESSORIES

15

MINIATURE MATRIX

18

TELEDYNE CUSTOM SOLUTIONS

19

OTHER TELEDYNE PRODUCTS

20-24

SINGLE PHASE AC

Series SH High Industrial Performance (HIPpak)

AC Solid-State Relays with Covers

Series SH relays offer high performance in a flexible and innovative package. Designed for all types of loads, they provide output to 125A, 690Vac. They incorporate removable touch-proof terminal covers for versatile, easy, and quick connections. SH relays feature a metal baseplate and built-in LED. They are up to 30% lighter than standard relays.

- Random and zero-cross models available
- Low zero-cross turn-on voltage
- Input and output protection and control LED
- IP20 touch-proof terminal covers
- Heat sinks available



Part No.	Load Current	Load Voltage	Peak Voltage	Switch Type	Control Voltage	I ² t	Dimensions LxWxH
SH24A25	25A	12–275 Vac	600 Vpeak	Zero Cross	20–265 Vac/Vdc	600 A ² s	2.3 x 1.77 x 1.18 in. 58.5 x 45 x 30 mm
SH24A25T5	25A	12–275 Vac	600Vpeak	Zero Cross	20–265 Vac/Vdc	600 A ² s	
SH24D25	25A	12–275 Vac	600 Vpeak	Zero Cross	3–32 Vdc	600 A ² s	
SH48D35	35A	24–510 Vac	1200 Vpeak	Zero Cross	3.5–32 Vdc	1250 A ² s	
SH48A50	50A	24–510 Vac	1200 Vpeak	Zero Cross	20–265 Vac/Vdc	2500 A ² s	
SH48D95	95A	24–510 Vac	1200 Vpeak	Zero Cross	3.5–32 Vdc	14400 A ² s	
SH48R125	125A	24–510 Vac	1200 Vpeak	Random	3.5–32 Vdc	24000 A ² s	
SH48D125	125A	24–510 Vac	1200 Vpeak	Zero Cross	3.5–32 Vdc	24000 A ² s	
SH48A125	125A	24–510 Vac	1200 Vpeak	Zero Cross	20–265 Vac/Vdc	24000 A ² s	
SH60D50	50A	24–690 Vac	1600 Vpeak	Zero Cross	3.5–32 Vdc	2500 A ² s	
SH60D125	125A	24–690 Vac	1600 Vpeak	Zero Cross	3.5–32 Vdc	24000 A ² s	



See Appendix for heat-sink information and other options.
For SH48D75, contact factory for availability
RoHS Compliant..

ESPRESSO & COFFEE MACHINES

- Water tank heater
- Pump motor
- Grinder motor

SINGLE PHASE AC



Series STH High Industrial Performance (HIPpak) AC Solid-State Relays

Series STH relays offer high performance in a flexible and innovative package. Designed for all types of loads, they deliver output to 75A, 600Vac for resistive loads. They have removable touch-proof terminal covers for versatile, easy, and quick connections. STH relays feature a metal baseplate and are up to 30% lighter than standard relays.

- Regulated input current
- Low zero-cross turn-on voltage
- Input protection and control LED standard
- IP20 touch-proof terminal covers optional
- Heat sinks available

Part No.	Load Current	Load Voltage	Peak Voltage	Switch Type	Control Voltage	I ² t	Dimensions LxWxH
STH24D12	12A	12–280 Vac	600 Vpeak	Zero Cross	3–32 Vdc	128 A ² s	2.3 x 1.77 x 1.18 in. 58.5 x 45 x 30 mm
STH24D25	25A	12–280 Vac	600 Vpeak	Zero Cross	3–32 Vdc	600 A ² s	
STH24D35	35A	12–280 Vac	600 Vpeak	Zero Cross	3–32 Vdc	1250 A ² s	
STH48D50	50A	24–600 Vac	1200 Vpeak	Zero Cross	3–32 Vdc	2500 A ² s	



See Appendix for heat-sink information and other options.
IP20 touchproof covers option: -17
RoHS Compliant.
For STH48D35, contact factory for availability.

Series S AC Hockey Puck Solid-State Relays

The Series S single-phase relays are designed for all types of loads. The design incorporates an SCR or triac output. The relays utilize optical isolation to protect the control from load transients. All contain an internal snubber for output protection. High-current models are excellent for motor and UPS control.

- Low zero-cross turn-on voltage for low EMI
- AC or DC control available
- Excellent thermal performance
- High immunity to surges
- Internal snubber (except S60 models)



Part No.	Load Current	Load Voltage	Peak Voltage	Switch Type	Control Voltage	I ² t	Dimensions LxWxH
S24D25	25A	12–280 Vrms	600 Vpeak	Zero Cross	4–30 Vdc	288 A ² s	2.29 x 1.75 x 1.06 in. 58.2 x 44.5 x 27 mm
S24D40	40A	12–280 Vrms	600 Vpeak	Random	4–30 Vdc	612 A ² s	
S24R40	40A	12–280 Vrms	600 Vpeak	Zero Cross	3–30 Vdc	612 A ² s	
S24A40	40A	12–280 Vrms	600 Vpeak	Zero Cross	90–240 Vac/Vdc	612 A ² s	
S48D25	25A	24–520 Vrms	1200 Vpeak	Zero Cross	5–30 Vdc	265 A ² s	
S48A50	50A	24–520 Vrms	1200 Vpeak	Zero Cross	90–240 Vac/Vdc	1500 A ² s	
S48D50	50A	24–520 Vrms	1200 Vpeak	Zero Cross	5–30 Vdc	1500 A ² s	
S48A50-22/R**	50A	24–520 Vrms	1200 Vpeak	Zero Cross	17–80 Vac/Vdc	1500 A ² s	
S48R75	75A	24–520 Vrms	1200 Vpeak	Zero Cross	90–240 Vac/Vdc	1500 A ² s	
S48R125	125A	24–520 Vrms	1200 Vpeak	Random	4–30 Vdc	20000 A ² s	
S48R125-22	125A	24–520 Vrms	1200 Vpeak	Random	17–80 Vac/Vdc	20000 A ² s	
S60D125	125A	24–660 Vrms	1600 Vpeak	Zero Cross	7–30 Vdc	20000 A ² s	



See Appendix for heat-sink information and other options.
RoHS Compliant **S48A50-22 available with /R option

SINGLE PHASE AC



Series ST AC Hockey Puck Solid-State Relays

Series ST relays are designed for high-power applications. The design incorporates an SCR or triac output. The relays utilize optical isolation to protect the control from load transients. A control LED is available on certain models. All Series ST relays are zero crossing. Internal MOV is also available on ST24D 25A and 50A models.

- Tight zero-cross window for low EMI
- AC or DC control available
- Excellent thermal performance
- Internal MOV (certain models)
- Control LED (certain models)

Part No.	Load Current	Load Voltage	Peak Voltage	Switch Type	Control Voltage	I ² t	Dimensions LxWxH
ST24D12	12A	12–280 Vrms	600 Vpeak	Zero Cross	4–30 Vdc	72 A ² s	2.29 x 1.75 x 1.06 in. 58.2 x 44.5 x 27 mm
ST24D25	25A	12–280 Vrms	600 Vpeak	Zero Cross	4–30 Vdc	288 A ² s	
ST48D50	50A	24–600 Vrms	1200 Vpeak	Zero Cross	5–30 Vdc	1500 A ² s	

-02 = Control LED; -16 = Internal MOV; -22 = 24 Vac control
See Appendix for heat-sink information and other options.
RoHS Compliant



Series FS Miniature AC Solid-State Relays

Series FS relays are designed for medium-power loads. The relays incorporate a triac output and utilize optical isolation to protect the control from load transients. The package is available with faston or PCB terminals. The compact size of the FS makes it ideal for designs where space is limited. The FS has excellent thermal performance.

- Miniature package
- Faston or PCB terminals available
- Tight zero-cross window for low EMI
- Excellent thermal performance
- High immunity to surges

Part No.	Load Current	Load Voltage	Peak Voltage	Switch Type	Control Voltage	I ² t	Dimensions LxWxH
FS24D10-06	10A	12–280 Vrms	600 Vpeak	Zero Cross	4–30 Vdc	72 A ² s	1.18 x .83 x .59 in. 30 x 21 x 15 mm
FS24D10	10A	12–280 Vrms	600 Vpeak	Zero Cross	4–30 Vdc	72 A ² s	
FS24D20-06	20A	12–280 Vrms	600 Vpeak	Zero Cross	4–30 Vdc	200 A ² s	

-06 = Faston
RoHS Compliant available with option: /R



Series G AC Solid-State Relays

Series G relays are designed for medium-power loads. The design incorporates a thyristor output. Series G relays utilize optical isolation to protect the control from load transients. An internal MOV is also provided to protect against load transient voltages. The compact size makes it ideal for designs where space is limited.

- Miniature size package
- Power and control connections by Faston terminals
- Internal MOV protection
- Excellent thermal performance
- High immunity to surges

Part No.	Load Current	Load Voltage	Peak Voltage	Switch Type	Control Voltage	I ² t	Dimensions LxWxH
G24R12-06	12 Arms	12–320 Vrms	520 Vpeak	Random	3–32 Vdc	340 A ² s	2.63 x 1.50 x .87 in. 56.9 x 38 x 22 mm
G24D12-06	12 Arms	12–320 Vrms	520 Vpeak	Zero Cross	4–32 Vdc	340 A ² s	

-06 = Faston
RoHS Compliant

SINGLE PHASE AC



Series SHPXXNXXR



RoHS Compliant

Series SHP Phase-Control AC Solid-State Relays

The Series SHP phase-angle controller provides analog switching. It features an internal microcontroller and overvoltage protection. Choose relays with either removeable input spring connectors or IP20 touch-proof flaps. The relays are designed in conformity with EN60947-4-3 (IEC947-4-3) and EN60950/VDE0805 (Reinforced Insulation).

- Microcontroller inside
- Analog switching
- Overvoltage protection by varistor
- Green LED for input visualization
- Short-circuit protection

Part No.	Load Current	Load Voltage	Peak Voltage	Switch Type	Control Range	I ² t	Dimensions LxWxH
SHP24N50R	50A	90–280 Vac	600 Vpeak	Phase Angle	4–20 mA	2500 A ² s	1.77 x 2.30 x 1.18 in. 45 x 58.5 x 30 mm

RoHS Compliant

Series DH (slimpac) AC Solid State Relays



RoHS Compliant

Series DH relays are designed for all types of loads. These relays feature our new high efficiency back-to-back thyristors for long lifetime expectancy. The relays utilize optical isolation to protect the control from load transients. All relays offer a green control LED.

- New High Efficiency Back-to-Back Thyristors
- Zero-cross models designed for resistive loads
- Input protection and control LED standard
- IP20 protective cover
- Up to 600Vrms load voltage

Part No.	Load Current	Load Voltage	Peak Voltage	Switch Type	Control Voltage	I ² t	Dimensions LxWxH
DH24D25	25 Arms	12-280 Vrms	600 Vpeak	Zero Cross	3-32 Vdc	340 A ² s	3.58 x .89 x 1.65 in. 91 x 22.5 x 42 mm

RoHS Compliant

Series DRS AC Solid State Relays



RoHS Compliant

Series DRS relays are designed for all types of loads. These relays feature our new high efficiency back-to-back thyristors for long lifetime expectancy, with zero cross switching. The relays utilize optical isolation to protect the control from load transients.

- AC Semiconductor Contactor with Diagnostic
- Compact size and DIN rail mounting
- Zero Cross switch ON in case of overvoltage
- Large control range: 3-32Vdc
- IP20 housing
- UL conformity

Part No.	Load Current	Load Voltage	Peak Voltage	Switch Type	Control Voltage	I ² t	Dimensions LxWxH
DH24D25	32 Arms	12-280 Vrms	1200 Vpeak	Zero Cross	3-32 Vdc	1500 A ² s	3.15 x .89 x 4.69 in. 80 x 22.5 x 119.1 mm

RoHS Compliant

SINGLE PHASE AC



LS with HS1 heat sink



Series LS AC Solid-State Relays with Optional Heat Sinks

Series LS single-inline package (SIP) relays are designed for mounting on printed circuit boards. LS relays facilitate heat sinking by providing an metallic interface surface. The relays use a direct-bonded copper substrate for thermal efficiency, thermal stress performance and long-life expectancy. Optional heat sinks are available.

- Compact SIP package
- Designed for external heat-sink attachment
- Over-sized thyristor ratings (up to 50A)
- Direct-copper bonding technology
- Optional heat sinks available

Part No.	Load Current	Load Voltage	Peak Voltage	Switch Type	Control Voltage	I ² t	Dimensions LxWxH
LS24D16C	16A	12–280 Vrms	600 Vpeak	Zero Cross	4–14 Vdc	128 A ² s	LS: 1.72 x .96 x .25 in. 43.6 x 24.5 x 6.3 mm
LS24D16C-HS1	16A	12–280 Vrms	600 Vpeak	Zero Cross	4–14 Vdc	128 A ² s	
LS24D16N	16A	12–280 Vrms	600 Vpeak	Zero Cross	8–32 Vdc	128 A ² s	
LS60D22C	22A	24–600 Vrms	1200 Vpeak	Zero Cross	4–14 Vdc	450 A ² s	LS with H1 Heat Sink: 1.72 x 1.4 x .87 in. 43.6 x 35.7 x 22 mm
LS60D22C-HS1	22A	24–600 Vrms	1200 Vpeak	Zero Cross	4–14 Vdc	450 A ² s	
LS60D30C	30A	24–600 Vrms	1200 Vpeak	Zero Cross	4–14 Vdc	5000 A ² s	

-HS1 = With heat sink
RoHS Compliant

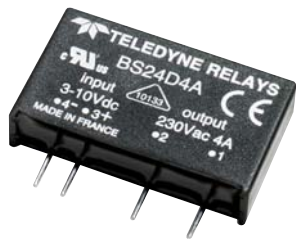

Series BS Single-Inline Package AC Solid-State Relays

Series BS 4-amp solid-state single inline (SIP) four-pin relays are designed for mounting on a printed circuit board. BS relays can withstand very high current overloads. The compact size and triac output make the BS relay an excellent choice for switching medium-power resistive loads.

- Industry-standard package
- High in-rush capabilities
- Low input current draw
- Low zero-cross turn-on voltage for low EMI
- Up to 600Vrms load voltage

Part No.	Load Current	Load Voltage	Peak Voltage	Switch Type	Control Voltage	I ² t	Dimensions LxWxH
BS24D4A	4 Arms	15–280 Vrms	600 Vpeak	Zero Cross	3–10 Vdc	72 A ² s	1.70 x 1.0 x .39 in. 43.2 x 25.4 x 10.2 mm

RoHS Compliant

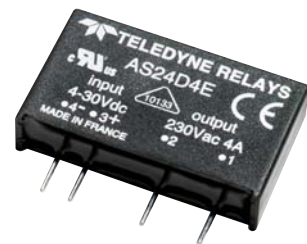

Series AS4 Single-Inline Package AC Solid-State Relays

Series AS4 solid-state single inline (SIP) four-pin relays are designed for mounting on a printed circuit board. The relays offer built-in voltage protection and can withstand very high current overloads. The relays have a low zero-cross window. The compact size and triac output make the AS relay the perfect retrofit for electromechanical relays.

- Industry-standard package
- Tight zero-cross window for low EMI
- Low input current draw
- Integral transient voltage protection
- DIN rail available

Part No.	Load Current	Load Voltage	Peak Voltage	Switch Type	Control Voltage	I ² t	Dimensions LxWxH
AS24D4E/R	4 Arms	12–275 Vrms	600 Vpeak	Zero Cross	4–30 Vdc	50 A ² s	1.70 x 1.0 x .39 in. 43.2 x 25.4 x 10.2 mm
A24D4E-X1	4 Arms	12–275 Vrms	600 Vpeak	Zero Cross	6-30 Vdc	50 A ² s	
AS46D4E/R	5 Arms	12–460 Vrms	800 Vpeak	Zero Cross	4–30 Vdc	72 A ² s	

-02 = LED; X1 = DIN rail clip with LED; X2 = DIN rail clip without LED
RoHS Compliant

WIRING EXAMPLES

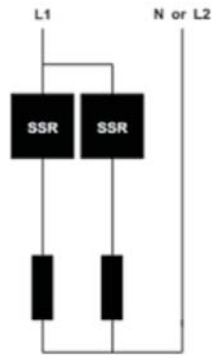

2 load control wiring
Single phase

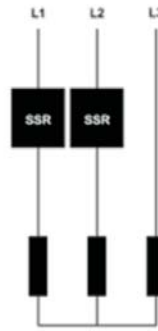

Two-phase SSR SOB to control heaters
connected in star
(for balanced low voltage loads without
neutral connection)

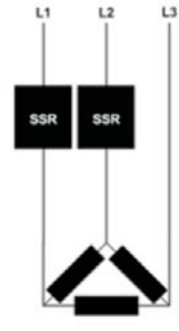

Two-phase SSR SOB to control heaters
connected in delta
(for high voltage, balanced or
unbalanced loads)



Series SD Dual-Output AC Solid-State Relays

Series SD dual-phase relays are designed for all types of loads. The design incorporates two relays in a single package. The relays utilize optical isolation to protect the control from load transients. High-current models are excellent for motor and phase angle control. SD Series are available with faston or screw terminals.

- Designed for all types of loads
- Dual output (two relays in one package)
- Faston or screw terminals
- Tight zero-cross window for low EMI
- High immunity to surges

Part No.	Load Current	Load Voltage	Peak Voltage	Switch Type	Control Voltage	I ² t	Dimensions LxWxH
SD24D40-06	40 Arms	12–280 Vrms	600 Vpeak	Zero Cross	4–30 Vdc	612 A ² s	2.28 x 1.75 x 1.26 in. 58 x 44.5 x 32 mm
SD24R50	50 Arms	12–280 Vrms	600 Vpeak	Random	4–30 Vdc	1500 A ² s	2.28 x 1.75 x 1.06 in. 58 x 44.5 x 27 mm
SD24D50-06	50 Arms	12–280 Vrms	600 Vpeak	Zero Cross	4–30 Vdc	1500 A ² s	2.28 x 1.75 x 1.26 in. 58 x 44.5 x 32 mm
SD48D50A	50 Arms	24–600 Vrms	1200 Vpeak	Zero Cross	10–30 Vdc	1500 A ² s	2.28 x 1.75 x 1.06 in. 58 x 44.5 x 27 mm
SD48D50A2	50 Arms	24–600 Vrms	1200 Vpeak	Zero Cross	10–30 Vdc	1500 A ² s	2.28 x 1.75 x 1.40 in. 58 x 44.5 x 35.6 mm
SD48D40-06	40 Arms	24–510 Vrms	1200 Vpeak	Zero Cross	5–30 Vdc	612 A ² s	2.28 x 1.75 x 1.26 in. 58 x 44.5 x 32 mm



RoHS Compliant

-06 = Faston terminals See Appendix for heat-sink information and other options.
RoHS Compliant

THREE PHASE AC

■ WIRING EXAMPLES

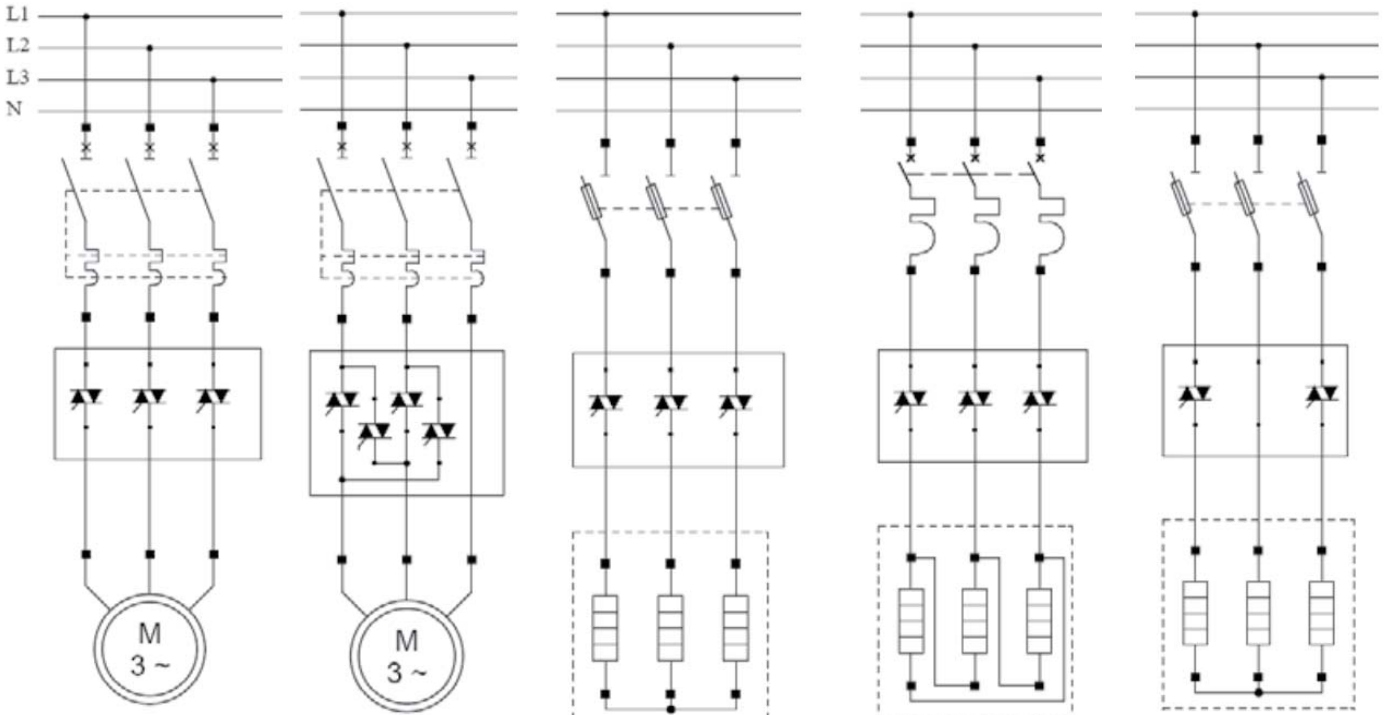

Three-phase SSR SVT8/SGT8 controlling a three-phase motor with a thermal - magnetic protection.

Motor reverser SV9 for three-phase asynchronous motor

Three-phase SSR SCT/SVT/SGT to control heaters connected in star with fuses protection.

Three-phase SSR SCT/SVT/SGT to control heaters connected in delta with circuit-breaker.

2 legs three-phase SSR SGB to control heaters connected in star with fuses protection.



Series E3P Three-Phase AC Solid-State Relays

Series E3P three-phase relays are designed for all types of loads. The design incorporates an oversized thyristor output. Control status LED is standard on all models. Output protection is provided internally on certain models. The E3P is available in random and zero-cross turn-on. High-current models are ideal for motor control.

- Three-phase output
- AC or DC control
- Internal output protection
- Tight zero-cross window for low EMI
- High immunity to surges

Part No.	Load Current	Load Voltage	Peak Voltage	Switch Type	Control Voltage	I ² t	Dimensions LxWxH
E3P48A50	50A	24-600 Vrms	1200 Vpeak	Zero Cross	90-240 Vac	1500 A ² s	3.94 x 2.89 x 1.56 in. 100 x 73.5 x 39.5 mm
E3P48A75	75A	24-600 Vrms	1200 Vpeak	Zero Cross	90-240 Vac	5000 A ² s	
E3P48A75-22	75A	24-600 Vrms	1200 Vpeak	Zero Cross	10-30 Vac	5000 A ² s	
E3P48D25	25A	24-600 Vrms	1200 Vpeak	Zero Cross	8.5-30 Vdc	265 A ² s	
E3P48D50	50A	24-600 Vrms	1200 Vpeak	Zero Cross	8.5-30 Vdc	1500 A ² s	
E3P48D75	75A	24-600 Vrms	1200 Vpeak	Zero Cross	8.5-30 Vdc	5000 A ² s	
E3P48D75-16	75A	24-520 Vrms	1200 Vpeak	Zero Cross	8.5-30 Vdc	5000 A ² s	



-14 = Touch-proof cover
-16 = Internal protection
RoHS Compliant.

For E3P48R50-16, contact factory for availability.

THREE PHASE AC

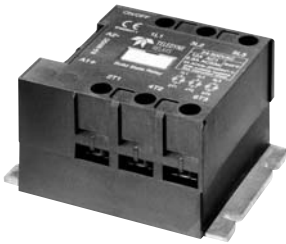

Series E3PT Three-Phase Touch-Proof AC Solid-State Relays

Series E3PT three-phase solid-state relays are designed for all types of loads. The E3PT relays include as a standard a control LED for visual status. The E3PT is touch-proof for user safety. An internal MOV and snubber circuit protect the output thyristor. The E3PT relays are highly immune to large current surges.

- Designed for all types of loads
- Tight zero-cross window for low EMI
- Control LED on all models
- Internal output transient protection
- IP20 touch-proof

Part No.	Load Current	Load Voltage	Peak Voltage	Switch Type	Control Voltage	I ² t	Dimensions LxWxH
E3PT48D50	50A	24–520 Vrms	1200 Vpeak	Zero Cross	8.5–30 Vdc	7200 A ² s	3.94 x 2.99 x 2.22 in. 100 x 76 x 56.5 mm

H = High surge capability

RoHS Compliant.

For E3PT48D50H and E3PT48A50H, contact factory for availability.



Series C3P Three-Phase AC Solid-State Relays

Series C3P relays control medium amounts of power in three-phase applications. Optical isolation ensures complete protection of the C3P's control circuit from load transients. The compact plastic housing provides a low-cost alternative to large metallic three-phase contactors. The ceramic baseplate provides excellent thermal performance.

- Three-phase relay in a compact single-inline package
- High-temperature plastic housing
- Tight zero-cross window for low EMI
- Exposed ceramic baseplate for reduced thermal resistance

Part No.	Load Current	Load Voltage	Peak Voltage	Switch Type	Control Voltage	I ² t	Dimensions LxWxH
C3P24D25	25 Arms	24–280 Vrms	600 Vpeak	Zero Cross	10–30 Vdc	260 A ² s	3.2 x 1.09 x 0.32 in
C3P24D25C	25 Arms	24–280 Vrms	600 Vpeak	Zero Cross	3.5–10 Vdc	260 A ² s	81.9 x 27.7 x 8.3 mm

Lead forming available upon request.



■ STEAM & INDUSTRIAL OVENS

- Steam heating element
- Oven heating element
- Circulation fan

THREE PHASE AC



Series S3P Three-Phase AC Solid-State Relays

Series S3P relays are made up of three separate relays controlled by a common DC voltage control. They are designed to control 10A AC loads such as resistors and small motors on a mains from 12 to 440 Vac, either single- or three-phase. They are well suited for applications requiring compact size and low cost.

- Industry-standard hockey-puck package
- Spring connectors
- Three relays in a single package
- Zero-cross and random turn-on options
- RoHS Compliant available with option -/R

Part No.	Load Current	Load Voltage	Peak Voltage	Switch Type	Control Voltage	I ² t	Dimensions LxWxH
S3P44D10	10 Arms	12–440 Vrms	850 Vpeak	Zero Cross	4–30 Vdc	72 A ² s	2.3 x 1.75 x 1.14 in. 44.5 x 58.5 x 29 mm

See Appendix for heat-sink information and other options.
RoHS Compliant

QUAD OUTPUT AC



Series SQ Quad-Output AC Solid-State Relays

Series SQ relay provides four independent 25A relays in a standard hockey-puck package. The SQ package conserves space while providing high-power switching. The tight zero-cross window reduces the EMI level. Optical isolation ensures complete protection of the control circuit from load transients.

- Four solid-state relays in a hockey puck package
- Tight zero-cross window for low EMI
- Constant current input for low current draw
- High Immunity to surges
- RoHS Compliant available with option -/R

Part No.	Load Current	Load Voltage	Peak Voltage	Switch Type	Control Voltage	I ² t	Dimensions LxWxH
SQ24D25	25 Arms	12–280 Vrms	600 Vpeak	Zero Cross	3–32 Vdc	288 A ² s	2.28 x 1.75 x 1.29 in. 58 x 44.5 x 33 mm

See Appendix for heat-sink information and other options.
RoHS Compliant

- **MOSFET**
for applications where overcurrent capability and low dissipated power are needed
- **Bipolar**
for applications where low control current is needed
- **IGBT**
for high voltage applications (> 600 VDC)

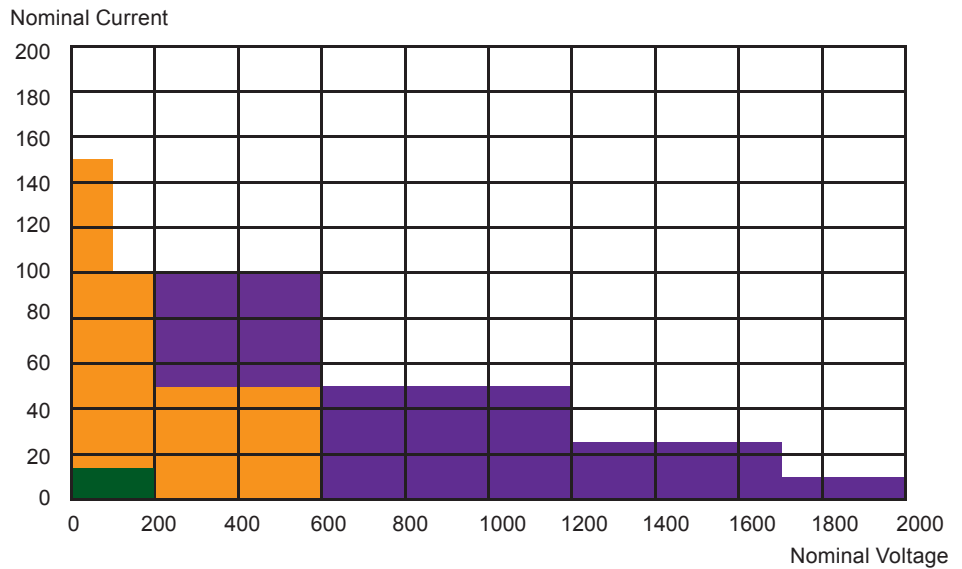

MOSFET



Series S20, S60 and S75 DC Solid-State Relays

Series S20 and S60 relays switch medium- to high-power DC loads. These devices feature the latest-generation MOSFET technology as well as an innovative isolated driver to ensure fast power turn on and off. The relays feature triggered control input to avoid linear control risks and fast switching times. The relays also offer an LED for status.

- Low on-state resistance
- Low output leakage current
- Low control current consumption
- Triggered control input to avoid linear control risks
- Low conducted and radiated disturbances

Part No.	Load Current	Load Voltage	Peak Voltage	Turn-On Time	Control Voltage	ON Resistance	Dimensions LxWxH
S20DC100	100A	0–130 Vdc	200 Vpeak	10 μs	4.5–32 Vdc	22 mΩ	2.29 x 1.75 x 1.1 in. 58.2 x 44.5 x 28 mm
S20DC30	30A	0–130 Vdc	200 Vpeak	10 μs	4.5–32 Vdc	164 mΩ	
S60DC40	40A	0–350 Vdc	600 Vpeak	10 μs	4.5–32 Vdc	70 mΩ	
S75DC150	150A	0–42 Vdc	75 Vpeak	10 μs	4.5–32 Vdc	2.25 mΩ	



*275 Vrms size 20 varistor as protection across the output
See Appendix for heat-sink information and other options.
RoHS Compliant



Series SH DC Solid-State Relays

Series SH relays offer high performance in a flexible, innovative package. They feature the latest-generation MOSFET technology as well as triggered control input to avoid linear control risks. The relays offer diagnostics, removable touch-proof terminal covers and a metal baseplate. They are up to 30% lighter than standard relays.

- Built-in diagnostics with status LED
- Ultra low on-state resistance
- Low output leakage current
- IP20 protection by terminal covers on load terminals
- No radiated or conducted disturbances

Part No.	Load Current	Load Voltage	Peak Voltage	Turn-On Time	Control Voltage	ON Resistance	Dimensions LxWxH
SH10DC40	40A	5–100 Vdc	100 Vpeak	20 μs	3.5–32 Vdc	30 mΩ	2.3 x 1.77 x 1.18 in. 58.5 x 45 x 30 mm
SH10DC40-16	40A	5–60 Vdc	100 Vpeak	20 μs	3.5–32 Vdc	30 mΩ	



-16 = Internal protection
See Appendix for heat-sink information and other options.
RoHS Compliant

MOSFET



Series LS10 DC Solid-State Relays

Series LS10 DC solid-state relays are designed for mounting on printed circuit boards. They facilitate heatsinking by providing an interface surface. They can switch loads with high starting currents. The nominal switched currents depend on the size of the heat sink. The relays use a direct-bonded copper substrate for thermal efficiency and long life.

- Slim compact design
- Heatsinking capabilities
- Integrated voltage protection
- High surge handling capability
- MOSFET output

Part No.	Load Current	Load Voltage	Peak Voltage	Turn-On Time	Control Voltage	ON Resistance	Dimensions LxWxH
LS60DC10C-21	10A	7–36 Vdc	60 Vpeak	10 μ s	3–10 Vdc	20 m Ω	1.71 x 0.96 x 0.25 in.
LS60DC10F-21	10A	7–36 Vdc	60 Vpeak	10 μ s	7–30 Vdc	20 m Ω	43.6 x 24.5 x 6.3 mm



-21 = Self turn-on suppression
RoHS Compliant



Series PS

Series PS DC Solid-State Relays

Series TS and Series PS relays provide AC/DC switching in a compact size. They also provide AC/DC control. These relays can withstand high surge currents. TS and PS relays are pin-to-pin compatible with electromechanical relays and may be used as replacements. Applications include vending machines, lighting and fans.

- Compact size
- Pin-to-pin compatible with electromechanical relays
- AC and DC control; AC and DC output
- Random and zero-cross turn-on voltage
- High inrush capabilities

Part No.	Load Current	Load Voltage	Peak Voltage	Turn-On Time	Control Voltage	ON Resistance	Dimensions LxWxH
PS3R5G	5A	0–30 V	60 Vpeak	50 μ s	10–30 Vdc	2100 Ω	1.14 x .50 x 1 in. 29 x 12.7 x 25.4 mm



RoHS Compliant

■ BATTERY POWER SYSTEMS

- Solar charging
- Shipboard secondary power



Series DS Single-Inline Package DC Solid-State Relays

Series DS single inline package (SIP) four-pin relays are designed for mounting on printed circuit boards. The relays are designed for medium-power DC loads. The Series DS relay is an alternative to electromechanical and reed relays. The DS series relays offers a long life versus mechanical relays.

- Industry-standard package
- Surge tolerant
- Compact size
- Designed for medium-power DC loads
- Solid-state technology offering long life



RoHS Compliant

Part No.	Load Current	Load Voltage	Peak Voltage	Turn-On Time	Control Voltage	ON Resistance	Dimensions LxWxH
DS6R3E	3A	2-60 V	60 V _{peak}	200 μs	3-30 Vdc	1000 Ω	1.70 x 0.98 x 0.39 in. 43.2 x 25.4 x 10.2 mm



RoHS Compliant

Series DX DIN-Rail DC Solid-State Relays

Series DX relays are designed for DIN-rail mounting. These solid-state relays include a control LED that provides visual control status. Its compact size and user-friendly package make the Series DX relay an excellent choice for designers. The DX series relays offers long life versus mechanical relays.

- Solid-state relays for DIN-rail mounting
- Control visualization by LED
- AC/DC control
- High immunity to surges
- Compact design

Part No.	Load Current	Load Voltage	Peak Voltage	Turn-On Time	Control Voltage	ON Resistance	Dimensions LxWxH
DX6R3E-02	3A	2-60 V	60 V _{peak}	20 μs	3-30 Vdc	600 Ω	3.01 x 2.09 x 0.48 in. 76.4 x 53 x 12.2 mm



DC MOTORS

- Crane motor control
- Material equipment motor drive



Series SI DC Solid-State Relays

Series SI relays are designed to switch high voltage (high power) DC loads. These devices feature the latest generation of High Voltage IGBT Technology as well as an innovative isolated driver to ensure fast power turn on and OFF. The relays feature triggered control input to avoid linear control risks and fast switching times. The relays also offer an LED for status.

- Latest generation of High Voltage IGBT Technology
- Ultra low output leakage current
- Low control current consumption
- Triggered control input to avoid linear control risks
- Low conducted and radiated disturbances

Part No.	Load Current	Load Voltage	Peak Voltage	Turn-On Time	Control Voltage	ON-State Voltage Drop	Dimensions LxWxH
SI60DC100	100A	0-500 Vdc	600 Vpeak	10 μ s	4.5-32 Vdc	1.35 V	2.29 x 1.75 x 1.1 in. 58.2 x 44.5 x 28 mm
SI120DC50	50A	0-1000 Vdc	1200 Vpeak	10 μ s	4.5-32 Vdc	1.5 V	
SI170DC25	25A	0-1400 Vdc	1700 Vpeak	10 μ s	4.5-32 Vdc	3.3 V	



See Appendix for heat-sink information and other options.
RoHS Compliant



Series SHI

Series SHI DC Solid-State Relays

Series SHI relays are designed to switch high voltage (high power) DC loads. These devices feature the latest generation of High Voltage IGBT Technology. This SSR comes with built-in Diagnostic features. The SHI Series is built with many protection features including protection for transient voltage bursts, overload and short circuits of the load.

- Latest generation of IGBT Technology
- Ultra low drop out voltage
- Built-in protection against overvoltage and fast transient burst
- Built-in over-temperature protection
- Pluggable control connector with spring terminals

Part No.	Load Current	Load Voltage	Peak Voltage	Turn-On Time	Control Voltage	ON Resistance	Dimensions LxWxH
SHI75DC50-6	50A	12-940 Vdc	1270 Vpeak	50 μ s	24-48 Vdc	35 Ω	5.67 x 2.67 x 3.27 in. 144 x 68 x 83 mm
SHI75DC50-9	50A	12-940 Vdc	1270 Vpeak	50 μ s	72-110 Vdc	35 Ω	



RAILWAY INDUSTRY

- HVAC System
- Hydraulic/pneumatic pumps
- Railway switch points
- Traffic Signaling

MOTOR CONTROLLER



RoHS Compliant

Series EMCRT Three-Phase Motor Reverser up to 7.5kW Motors

The Series EMCRT three-phase induction motor reverser can be used to turn on an industrial motor in either direction safely. It is designed to control and invert the direction of a three-phase motor. The reverser incorporates very-high-immunity components and can be mounted on a DIN rail or attached with screws.

- Controls and reverses three-phase motors without direct third leg (two legs)
- IP20 touch-proof housing
- Built-in snubber and MOV
- Forward/Reverse display LED

Part No.	Motor Current	Mains Voltage	Peak Voltage	Switch Type	Control Voltage	I ² t	Dimensions LxWxH
EMCRT48D50	8.5A	24–520 Vac	1600 Vpeak	Zero Cross	12–30 Vdc	1500 A ² s	3.94 x 2.99 x 2.22 in.
EMCRT48D75	16A	24–550 Vac	1600 Vpeak	Zero Cross	12–30 Vdc	5000 A ² s	100 x 76 56.5 mm

RoHS Compliant



EMC48S50-04

Series EMC Soft-Start Motor Controller up to 26kW Motors

The Series EMC motor controllers provide an alternative to costly and large variable speed controllers in pumps, fans, compressors and conveyors. Its six-thyristor structure, working like a full-wave phase angle controller, reduces the induction motor starting current as well as the motor starting torque to improve the efficiency of the power used.

- Controls both positive and negative cycles
- Avoids voltage fluctuations that lead to flicker
- Fits existing applications without modification of the wiring field configuration
- Features diagnostic and self-test functions

Part No.	MAIN CHARACTERISTICS						Phase to Phase Voltage	Mains Frequency	Input	Operating Temperature
	Max. Motor Power @40°C				IAC53a @40°C					
	Star (Y)		Delta (D)		Max.	EN60947-4-2				
EMC48S50-04	15kW	8.6kW	26kW	15kW	30A	22.5A	200 to 480Vac	40 to 65Hz	10 to 24Vdc	-40°C to +100°C



RoHS Compliant

PROTECTION MODULE



RoHS Compliant

Series PR Protection Module

SSeries PR is a protection module that helps protect DC solid-state relays against voltage transients due to inductive effects of lines and loads. The PR Series offer 2 types, one with additional output protection for DC relays that already have built-in MOV and one with a full protection scheme for relays that have no built-in protection. The PR Series also features IP20 touch-proof covers.

- External protection for DC Solid-State Relays
- Fly wheel diode
- Decoupling capacitor and discharge resistor
- Clamping voltage function
- IP20 touch-proof flaps

Part No.	Load Current	Load Voltage	Peak Voltage	Recover Time	Vdrop During Fly Wheel	Discharge Time Constant	Dimensions LxWxH
PR20DC80	0-80A	0-130 Vdc	200 Vpeak	190 ns	1.2 V	2 s	2.3 x 1.77 x 1.18 in.
PR75DC80	0-80A	0-40 Vdc	75 Vpeak	190 ns	1.2 V	1 s	58.5 x 45 x 30 mm

See Appendix for heat-sink information and other options.

RoHS Compliant

ACCESSORIES

Part Number	Thermal Characteristics	Specifications	Dimensions mm	Relay Type	Fig.
FW031	0.3 °C/W	DIN rail or screw - fan supply 230Vac	110 x 120 x 145	SH, S, E3P, E3PT	1
FW108	1.1 °C/W	for DIN rail or screw	89.8 x 81 x 98.02	SH, S	2
FW151	2.2 °C/W	for DIN rail or screw	45 x 73 x 80	SH, S, DH,	3



1

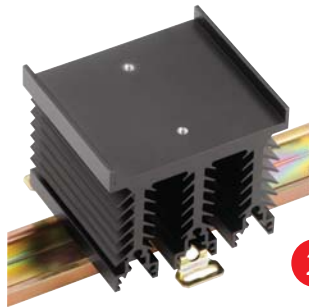

2

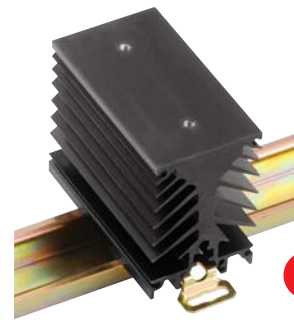

3

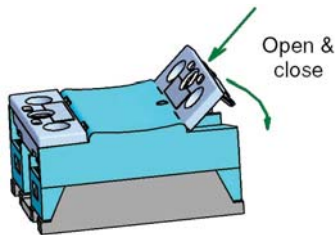

Removable IP20 touch-proof terminal covers on HIPPak



PROTECTION COVER / FLAPS

47001	Protection cover for S
47002	Protection cover for SD
47003	Protection cover for E3P
1LK00600	Protection cover for STH

DIN RAIL ADAPTER

DL12	DIN Rail Clip
------	---------------



THERMAL PAD

46488	Thermal pad attached
-------	----------------------

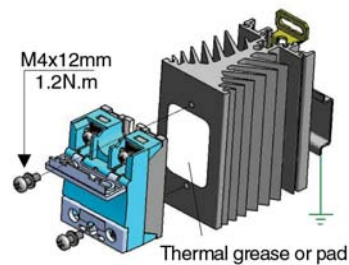

HARDWARE KIT

1LK00700	Buss-Bar hardware kit for SH
----------	------------------------------

Description

The InP1012 Series is a highly compact, reflective SPDT Active RF switch, manufactured using Teledyne's high speed, low-loss InP HEMT process. The switch die is packaged in a low-loss, surface mount package, with a small form factor: 3mm(L) x 3mm(W) x 1mm(H). It supports a wide frequency range from DC to 60GHz, and delivers low insertion loss, fast switching time, and good isolation-making this switch ideal for test and measurement, microwave communications, and radar applications. The unique construction features and manufacturing techniques provide excellent robustness to environmental extremes and overall high reliability

Features

- High digital bandwidth, greater than 40Gbps
- Very high linearity
- Low insertion loss
- Very fast switching time of less than 100ns
- Radiation tolerant up to 100 krad

Frequency Range
DC -60GHz
Bit Rate
40+ Gbps
Operate Time
60-100ns
Enclosure
Low-Loss Surface Mount Package
Dimensions
3mm (L) x 3mm (W) x 1mm (H)
Temperature
Storage: -65°C to +125°C
Operating: -65°C to +125°C

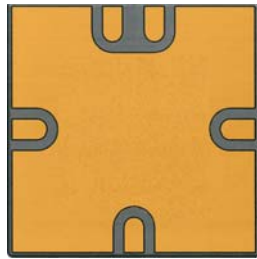
Part No.	Typical RF Performance			
	Frequency	Insertion Loss (dB)	Isolation (dB)	Return Loss (dB)
 InP1012	DC (20mV-200mV)	2.0	---	---
	10KHz	0.9	67	---
	100MHz	1.2	60	23
	6GHz	1.6	37	21
	14GHz	2.0	30	21
	20GHz	2.3	27	23
	30GHz	2.6	24	26
	40GHz	2.9	21	25
	50GHz	3.3	19	25
	60GHz	3.7	17	16

TYPICAL SIGNAL INTEGRITY CHARACTERISTICS @ 40Gbps

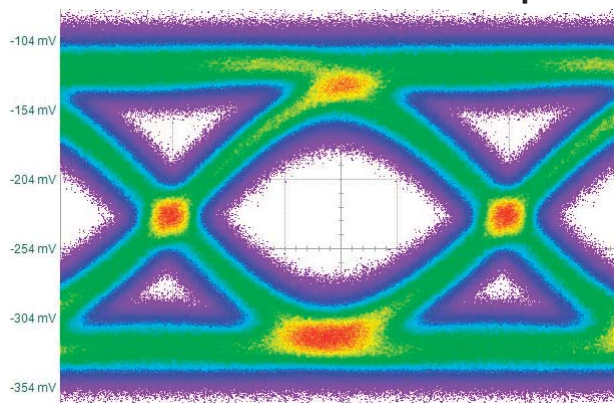

PATTERN GENERATOR SETTINGS

- 2³¹-1 PRBS signal
- 40Gbps data rate
- Data amplitude of 500mVpp

OUTLINE DIMENSIONS

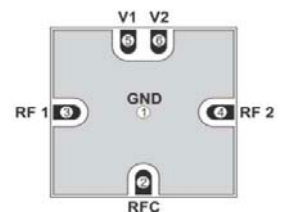
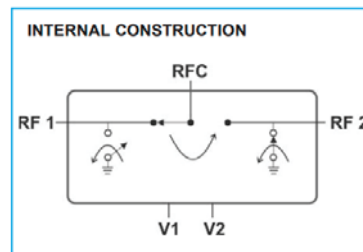
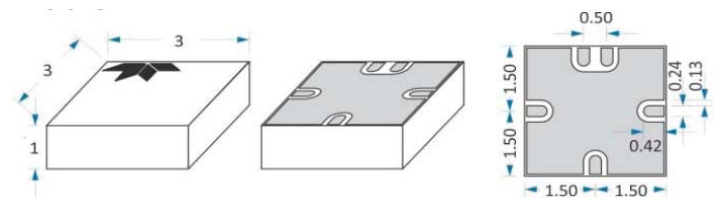

Series RF121 / GRF121

SPDT Magnetic-Latching
Up to DC-18GHz RF Relay
Signal Integrity up to 40Gbps





Series GRF121 Electromechanical Relays

The ultraminiature GRF121 relay is designed to provide a practical surface-mount switching solution with RF performance and repeatability to 18GHz. The GRF121 improves on Teledyne Relays' heritage of miniature RF relays by incorporating a precision transmission line structure in the internal construction of the contact system. GRF121 relays feature a unique ground shield to facilitate surface mounting and to extend the frequency range when compared to through-hole solutions.

- Broader bandwidth (DC - 18GHz)
- Excellent Signal integrity up to 40Gbps
- Hermetically Sealed
- High Resistance to ESD
- Metal Enclosure for EMI shielding
- High Repeatability
- 3 Million Cycle Life

Relay Type
SPDT Magnetic-Latching
Frequency Range
RF121 = DC - 12GHz GRF121 = DC - 18GHz
Bit Rate
RF121 = 20Gbps GRF121 = 40Gbps
Mounting
RF = Thru-hole GRF = Surface-Mount (Stub)
Available Coil Voltages
5V: Coil Resistance (Ω) = 61 12V: Coil Resistance (Ω) = 500
Temperature
Storage: -65°C to $+125^{\circ}\text{C}$ Operating: -55°C to $+85^{\circ}\text{C}$

Part No.	Typical RF Performance			
	Frequency (GHz)	VSWR (max)	Isolation (dB)	Insertion Loss (dB) (max)
 RF121	DC - 4	1.3 : 1	55	0.25
	4 - 8	1.50 : 1	50	0.45
	8 - 12	2.0 : 1	40	1.35
 GRF121	DC - 4	1.1 : 1	65	0.2
	4 - 8	1.20 : 1	50	0.2
	8 - 12	1.35 : 1	40	0.5
	12 - 16	2.0 : 1	30	0.95
	16 - 18	2.3 : 1	30	1.1

RF121 : 20Gbps

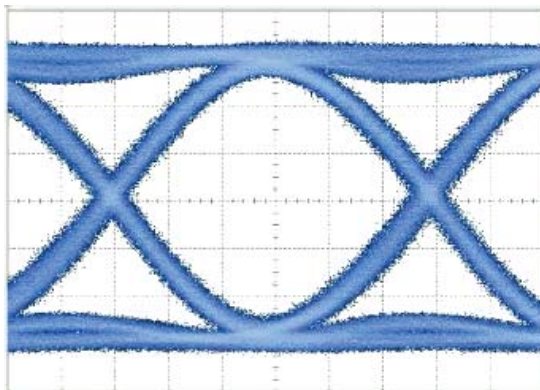

Bit Rate	Eye Height	Eye Width	Jitter _{p,p}
20Gbps	360 mV	40.3 ps	6.93 ps

PATTERN GENERATOR SETTINGS

- 20Gbps Random Pulse Pattern Generator
- $2^{31} - 1$ PRBS signal
- PRBS output of 500 mV_{p,p} (nominal)
- RF PCB effect (negligible) not removed from measurement
- Data shown is typical of both contacts

GRF121 : 40Gbps

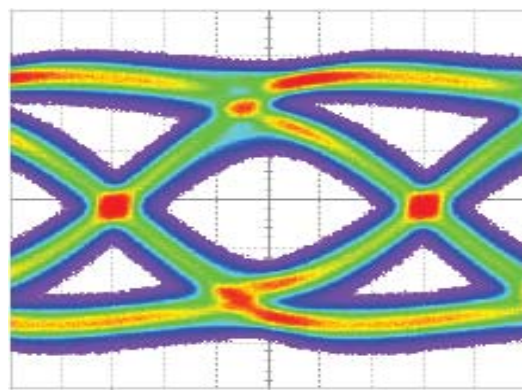

Bit Rate	Eye Height	Eye Width	Jitter _{p,p}
40Gbps	95 mV	13.34 ps	8.73 ps

PATTERN GENERATOR SETTINGS

- 40Gbps Random Pulse Pattern Generator
- $2^{31} - 1$ PRBS signal
- PRBS output of 500 mV_{p,p} (nominal)
- RF PCB effect (negligible) not removed from measurement
- Data shown is typical of both poles

Description

The Mini Matrix Series is an ideal solution that incorporate Teledyne Coax Switches' for off the self, easy to use application. The Mini Matrix Series is designed to allow the remote operation of SPDT, Transfer, or SP3T to SP8T Multi-Throw switches. Remote operation is accomplished via TCP/IP commands to the Matrix's Ethernet interface. Switch control is also accessible via the USB virtual serial port, using the provided command set. Through these interfaces the Coax Switch can be switched to the desired position and its position can be read for verification. The default switch position at power up can be set by the user.

Options

- USB only or USB & Ethernet Control
- Terminated or Non-Terminated
- Failsafe or Latching
- Various Connectors
- Multiple Frequency Ranges

Number of Switches	
1 to 2 SPDT, Transfer, or SP3T-SP8T	
Switching Type	
Electromechanical	
Temperature	
Operating: -40°C to +65°C	
Connector Types	Frequency Range
2.92 mm	DC - 40GHz
SMA	DC - 26.5GHz
Type N	DC - 12GHz
TNC	DC - 12GHz

Additional Information	
Available Connectors	SMA, 2.92 mm, Type N, TNC
Line Power	Universal 90-260 VAC, 47-63Hz
Enclosure A Size (WxHxD) (Non-Terminated SPMT)	5.08" Wide, 2.17" High, 7.75" Depth
Enclosure B Size (WxHxD) (Terminated SPMT)	8.00" Wide, 3.00" High, 8.00" Depth
Typical Cycle Life	5,000,000 cycles

ENCLOSURE DIMENSIONS

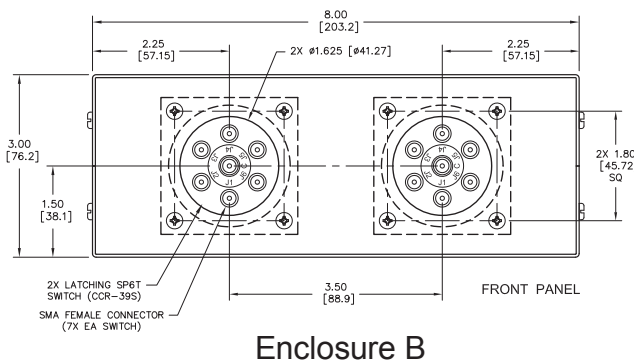
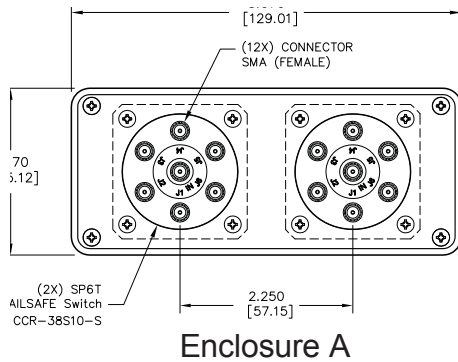

ENCLOSURE A - FRONT VIEW



ENCLOSURE A - REAR VIEW

Teledyne has over 50 years of experience in developing a wide spectrum of custom solutions.

Experienced in Custom Hybrid Solutions

Teledyne Relays is a leading manufacturer with the capability of providing build-to-print solutions on hybrid microcircuits devices. Our current products portfolio includes solid state power controllers, DC/DC converters, high current drivers, digital-analog converters, activator control hybrids, deflection amplifiers, base drivers, custom designed multi-layers thick-film/thin film substrates and many more...

With over 50 years of heritage in serving the space, aerospace, and defense markets, Teledyne continues to uphold the same standards and commitment to excellence. Our optimized solutions are supported by teams of engineers and manufacturing personnel with wide ranging experiences in developing products deployed in highly demanding applications, such as electrical power systems, radar receivers, and stores management solutions, for ground or aerial defense platforms.

Teledyne is accredited by Defense Logistics Agency (DLA) in accordance with MIL-PRF-38534, Class H and Class G Qualified Manufacturers List (QML). Since 2014 Teledyne has successfully launched over twenty hybrids into production for our customers. We welcome opportunities to partner with our customers to provide customized solutions to your hybrid needs. Our typical custom solution development cycle is as follows:



Teledyne Relays offers electromechanical relays for various markets?

RF RELAYS

- Signal Integrity up to 40Gbps
- DC - 18GHz
- Surface-Mount
- DPDT, SPDT, 4PST and Loopback Relays



MILITARY GRADE RELAYS

- Built and tested to meet MIL-PRF-39016
- Built and tested to meet MIL-PRF-28776
- Built-in Diodes, Transistor Driver and CMOS
- Low Power coils



TELEDYNE ESTABLISHED RELIABILITY RELAYS

- Fully defined product requirements and screening levels
- Spacer/Spreader pad options not allowed by military specifications
- Reduced lead time and cost vs Military Grade



HIGH PERFORMANCE RELAYS

- -65° C to +200° C
- Shock up to 4,000 g's
- Vibration up to 380 g's
- Non-Latching & Magnetic-Latching



COMMERCIAL RELAYS

- Standard electrical tests at 25° C
- "Low cost" switching solutions
- Surface-Mount
- Short lead times



Did you know...

Teledyne Coax Switches offers coaxial switches for ATE, Radar, Amplifier Switching, Etc.?

SPDT SWITCHES

- DC - 40GHz, Internal 50Ω Termination
- SMA, mini-SMB, TNC & N Connectors
- 5 Million Cycles
- High Power & Low PIM
- Failsafe & Latching



TRANSFER SWITCHES

- DC - 18GHz
- SMA, TNC & N Connectors
- 5 Million Cycles
- High Power
- Failsafe & Latching



MULTI-THROW SWITCHES

- DC - 40 GHz, Internal 50Ω Termination
- SMA, mini-SMB, TNC & N Connectors
- SP3T - SP10T
- 5 Million Cycles
- Normally Open & Latching



LOW PIM SWITCHES

- DC - 3 GHz
- SMA, N and 7/16 D Connectors
- SPDT, Transfer and Multi-Throw
- Failsafe & Latching



SPECIALTY SWITCHES

- DC - 40GHz
- 3-State Attenuated Switch
- Radiation Shielding
- Switch Blocks
- Redundant Diode Configuration



Did you know...

Teledyne Relays offers Military Solid State Relays?

DC SOLID STATE RELAYS

- Meet MIL-PRF-28750
- Tested Per MIL-STD-704
- Silicon Carbide MOSFET
- Up to 250Vdc, 1A
- Chassis and PCB Mount
- Short-Circuit Protection
- Plastic and Hermetically Sealed



BI-DIRECTIONAL/AC SOLID STATE RELAYS

- Meet MIL-PRF-28750
- Tested Per MIL-STD-704
- Up to 250Vac, 25A
- Chassis and PCB Mount
- Short-Circuit Protection
- Plastic and Hermetically Sealed

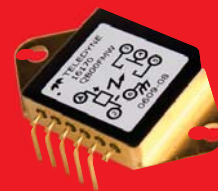

COMMERCIAL, LOW POWER, I/O MODULES

- Up to 250Vac, 10A
- Short-Circuit Protection
- Chassis and PCB Mount
- Zero-Cross & Random Switching
- Low Off-State Leakage Current



SILICON CARBIDE TECHNOLOGY

- Up to 270Vdc, 20 A
- Meet MIL-PRF-28750
- Tested Per MIL-STD-704
- Low ON resistance
- Low Profile Hermetic Package



Did you know...

Teledyne Coax Switches offers coaxial switch matrices for ATE, Radar, Filter Switching, Airborne Surveillance Systems, Etc.?

MINI MATRICES

- Remote Control via USB and/or Ethernet
- GUI controllable
- Accepts ASCII code
- Available in 18, 26.5 and 40 GHz
- SPDT, Transfer and Multi-throw configurations

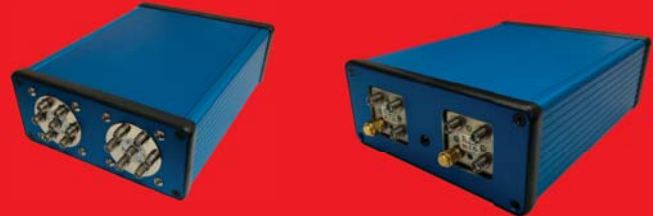

MULTIPLEXOR/FANOUT SWITCH MATRICES

- Up to 1x1024 Switch Matrix
- SMA, mini-SMB, TNC & N Connectors
- Failsafe, Latching or Normally Open Configurations
- Switching Systems for 50Ω & 75Ω applications

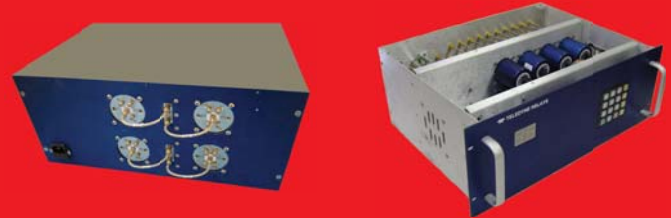

MIMO/BLOCKING AND MIMO SINGLE CONNECTION SWITCH MATRICES

- Up to 1x1024 Switch Matrix
- SMA, mini-SMB, TNC & N Connectors
- RS-232, TTL, USB, GPIB, TTL, Ethernet Control
- 1 Million Cycles
- Failsafe & Latching



CUSTOMIZED SWITCH MATRICES

- EMI/RFI
- Transient Suppression
- Ballistic Shock Fatigue
- Crash Load
- Altitude



Did you know...

Teledyne Relays offers Space Qualified Switches?

SPACE MARKET SEGMENTS SERVED

- *Deep-Space Probes*
- *Manned Programs*
- *Communications Satellites*
- *Launch Vehicles*
- *Earth Observatory / Weather Satellites*
- *Commercial / Military Satellites*



CAPABILITIES

- *Logistic Infrastructure*
- *Chemical Analysis Lab*
- *Scanning Electro Microscope*
- *In-house Plating Shop*
- *Environment Test Lab*
- *Field Technical Support*



ELECTROMECHANICAL RELAY SPECIFICATIONS

- *MIL-PRF-39016*
- *MIL-PRF-28776*
- *NASA/GSFC S-311-P-754*
- *NASA EEE-INST-002*
- *ESA/SCC 3601 & 3602*



HEADQUARTERS
12525 Daphne Ave.
Hawthorne, CA 90250
Phone: (323) 777-0077 or (800) 284-7007
Fax: (323) 241-1287
E-mail: relays@teledyne.com

EUROPE
9-13 Napier Road
Wardpark North
Cumbernauld G68 OEF
Scotland UK
Phone: +44 (0) 1236 453 124
Fax: +44 (0) 1236 780 651
E-mail: sales_europe@teledyne.com

www.teledyne.com
www.teledynerelays.com



TELEDYNE
RELAYS
Everywhereyoulook™