

Electromechanical Relays Selection Guide

Latching

JAN

Non-Latching

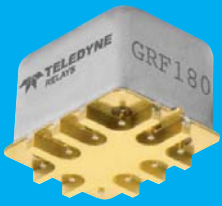

RF



DC - 18 GHz

Established
Reliability



Loopback

4PST



Environmental



Attenuated

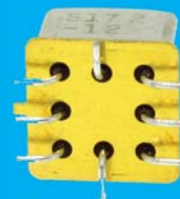

HEMT RF Switches

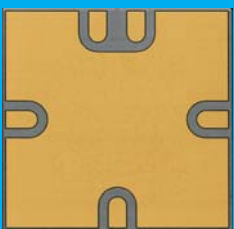

**TELEDYNE
RELAYS**

Everywhere you look™



RoHS or Non-RoHS:
Your Choice!



Switching Solutions

Teledyne Relays has been the world's innovative leader in the manufacture of ultraminiature, hermetically sealed, electromechanical and solid-state switching products for more than 50 years. The company's comprehensive product line meets a wide range of requirements for defense and aerospace, industrial, commercial, medical and RF & wireless applications.

Business Focus

- MIL QPL & COTS Solid-State Relays
- MIL QPL & COTS Electromechanical Relays
- HiRel (Space) Electromechanical Relays
- RF & Microwave Relays & Coaxial Switches
- Industrial Solid-State Relays
- Switching Matrices

Markets

- Commercial & Military Aviation
- Defense & Aerospace
- Telecom/Communications (Wireless)
- Instrumentation & Test
- Industrial Power & Motion Control
- Medical Applications
- IC Semiconductor Test
- Oil & Gas

Product Assurance

Under an aggressive Total Quality Management (TQM) program, Teledyne Relays has embraced a "continuous improvement" culture. With recognized certifications such as Boeing D6-82479, MIL-STD-790, AS/EN/JISQ9100:2009 (Rev C) and ISO 9001:2008 Teledyne Relays has become a primary supplier of switching solutions with the highest quality and reliability to industry leaders around the world.

Technical Service & Customer Support

Teledyne Relays provides easy access to technical service and customer support. Our websites make it easy to find technical information, buy products and even get e-mail responses within 24 hours. Switching solutions are only a mouse click away at www.teledynereleys.com or at teledyne-europe.com. Information about coax switches is available at www.teledynecoax.com.

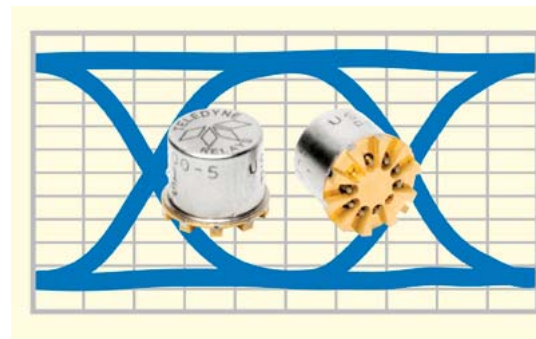

Teledyne Relays offer superior signal integrity up to 40 Gbps. See the RF relays section in our website.

Table of Contents

RF RELAYS		
Series	Description	Page
RF121 / GRF121	DC-18 GHz, Signal Integrity up to 40 Gbps , Mag-Latching SPDT	4-5
LB/GLB/SGLB363	LoopBack Relay with Built-in AC Bypass Capacitors	6-7
RF/GRF/SGRF/SRF300 RF/GRF/SGRF/SRF303	High Repeatability, Broadband TO-5 Relays, Non-Latching DPDT	8-9
SI800 / SI803	Signal Integrity up to 20 Gbps, Non-Latching DPDT	10-11
RF/GRF/SGRF100 RF/GRF/SGRF103	High Repeatability, Broadband Centigrd® Relays, Non-Latching DPDT	12
RF700/RF703	High Repeatability, Broadband Centigrd® Relays, Non-Latching DPDT	12
RF/GRF311 RF/GRF331	High Repeatability, Broadband TO-5 Relays, Non-Latching SPDT	13
RF341/GRF341	Broadband TO-5 RF Relays, Magnetic-Latching SPDT	13
RF255/257	High Power DPDT Half-Size Crystal Can Relay	14
GRF342	Surface-Mount TO-5 RF Relays, Magnetic-Latching DPDT	14
RF180/GRF180	Broadband RF Relays, Magnetic-Latching DPDT	15
GRF172	Surface-Mount Centigrd® RF Relays, Non-Latching DPDT	15
RF/GRF/SGRF424	Surface-Mount 4PST TO-5 Relay	16
RF310/RF313	High Repeatability TO-5 Relays, Normally Closed, Bypass	17
RF320/RF323	High Repeatability TO-5 Relays, Normally Open, Bypass	17
A150/GA150	Broadband Attenuator RF Relay	18
A152/GA152	Broadband Attenuator RF Relay	18
COMMERCIAL RELAYS		
122C	Centigrd® Relays (CMOS Compatible), Magnetic-Latching DPDT	19
172	Centigrd® Relays, Non-Latching DPDT	19
712	TO-5 Relays, Non-Latching DPDT	20
722	TO-5 Relays, Magnetic-Latching DPDT	20
732	TO-5 Relays, Non-Latching Sensitive DPDT	21
COMMERCIAL SURFACE-MOUNT RELAYS		
S114	Surface-Mount Centigrd® Relays, Non-Latching DPDT	22
S134	Surface-Mount Centigrd® Relays, Non-Latching Sensitive DPDT	22
S172	Surface-Mount Centigrd® Relays, Non-Latching DPDT	23
S422	Surface-Mount TO-5 Relays, Magnetic-Latching DPDT	23







See specific series for additional features and options

Continued on next page

Table of Contents

ESTABLISHED RELIABILITY RELAYS		
Series	Description	Page
ER114	Centigrad® Relays, Non-Latching DPDT	24
ER116C	Centigrad® Relays (CMOS Compatible), Non-Latching DPDT	24
ER134	Centigrad® Relays, Non-Latching Sensitive DPDT	25
ER136C	Centigrad® Relays (CMOS Compatible), Non-Latching Sensitive DPDT	25
ER411	TO-5 Relays, Non-Latching SPDT	26
ER431	TO-5 Relays, Non-Latching Sensitive SPDT	26
ER412	TO-5 Relays, Non-Latching DPDT	27
ER432	TO-5 Relays, Non-Latching Sensitive DPDT	27
255/257	Half-Size Crystal Can, Magnetic-Latching DPDT	28
ER421	TO-5 Relays, Magnetic-Latching SPDT	28
ER420	TO-5 Relays, Magnetic-Latching DPDT	29
ER422	TO-5 Relays, Magnetic-Latching DPDT	29
MILITARY QUALIFIED (JAN) RELAYS		
J114	Centigrad® Relays, Non-Latching DPDT	30
J116C	Centigrad® Relays (CMOS Compatible), Non-Latching DPDT	30
J134	Centigrad® Relays, Non-Latching Sensitive DPDT	31
J136C	Centigrad® Relays (CMOS Compatible), Non-Latching Sensitive DPDT	31
J411	TO-5 Relays, Non-Latching SPDT	32
J431	TO-5 Relays, Non-Latching Sensitive SPDT	32
J412	TO-5 Relays, Non-Latching DPDT	33
J432	TO-5 Relays, Non-Latching Sensitive DPDT	33
J255	Half-Size Crystal Can, Magnetic-Latching DPDT	34
J421	TO-5 Relays, Magnetic-Latching SPDT	34
J420	TO-5 Relays, Magnetic-Latching DPDT	35
J422	TO-5 Relays, Magnetic-Latching DPDT	35

Table of Contents

HIGH-PERFORMANCE RELAYS					
Description		Page			
412H/432H	High-Temperature (200°C) TO-5 Relays, Non-Latching DPDT	36			
422H	High-Temperature (200°C) TO-5 Relays, Magnetic-Latching DPDT	36			
412K	High-Shock TO-5 Relays, Non-Latching DPDT	37			
422K	High-Shock TO-5 Relays, Magnetic-Latching DPDT	37			
412V/432V	High-Vibration TO-5 Relays, Non-Latching DPDT	38			
APPENDIX					
	Signal Integrity Eye Diagrams	39-50			
	RoHS and Reach Certificate of Compliance	51			
	Part Numbering System	52-53			
	Dimensions	54-64			
	Handling Guidelines	65			
	Spacer Pad Options	66			
	Spreader Pad Options	67			
	Ground Pin Options	68			
	Established Reliability Program	69-70			
	Teledyne Relays HI-REL Program	71			
	InP1012-40 Active RF Switch	72			
	Teledyne Relays HI-REL Program	72-77			
	GRF Option TO-5 Relays with straight butt pins for surface-mount applications <small>* RF Relays Only</small>		SGRF Option TO-5 Relays with Gull-Wing (J-Lead) pins for surface-mount applications <small>* RF Relays Only</small>		GRF Option Centigrad® Relays with straight butt pins for surface-mount applications <small>* RF Relays Only</small>
	SGRF Option TO-5 Relays with Gull-Wing (J-Lead) pins for surface-mount applications <small>* RF Relays Only</small>		SRF Option Relays with Gull-Wing (J-Lead) pins for surface-mount applications <small>* RF Relays Only</small>		/S Option Relays with 0.187" trimmed leads <small>See Appendix: Part Numbering System</small>
	Spacer Pad Option Relays with polyester film pad to space between PCB and Relay Header <small>See Appendix: Spacer Pad Options</small>		Spreader Pad Option Relays with Diallyl Phthalate pad to spread pins <small>See Appendix: Spreader Pad Options</small>		/Q, /R Option Relays with solder dipped leads. Pb/Sn (60/40) or RoHS solder available <small>See Appendix: Part Numbering System</small>

See specific series for additional features and options



RF RELAYS

Series GRF121 Electromechanical Relays

The ultraminiature GRF121 relay is designed to provide a practical surface-mount switching solution with RF performance and repeatability to 18GHz. The GRF121 improves on Teledyne Relays' heritage of miniature RF relays by incorporating a precision transmission line structure in the internal construction of the contact system. GRF121 relays feature a unique ground shield to facilitate surface mounting and to extend the frequency range when compared to through-hole solutions.

- Broader bandwidth (DC - 18GHz)
- Excellent Signal integrity up to 40Gbps
- Hermetically Sealed
- High Resistance to ESD
- Metal Enclosure for EMI shielding
- High Repeatability
- 3 Million Cycle Life

Relay Type
SPDT Magnetic-Latching
Frequency Range
RF121 = DC - 12 GHz GRF121 = DC - 18 GHz
Bit Rate
RF121 = 20 Gbps GRF121 = 40 Gbps
Mounting
RF = Thru-hole GRF = Surface-Mount (Stub)
Available Coil Voltages
5V: Coil Resistance (Ω) = 61 12V: Coil Resistance (Ω) = 500
Temperature
Storage: -65°C to $+125^{\circ}\text{C}$ Operating: -55°C to $+85^{\circ}\text{C}$

Part No.	Typical RF Performance			
	Frequency (GHz)	VSWR (max)	Isolation (dB)	Insertion Loss (dB) (max)
 RF121	DC - 4	1.3 : 1	55	0.25
	4 - 8	1.50 : 1	50	0.45
	8 - 12	2.0 : 1	40	1.35
 GRF121	DC - 4	1.1 : 1	65	0.2
	4 - 8	1.20 : 1	50	0.2
	8 - 12	1.35 : 1	40	0.5
	12 - 16	2.0 : 1	30	0.95
	16 - 18	2.3 : 1	30	1.1

GRF121 RF Characteristics

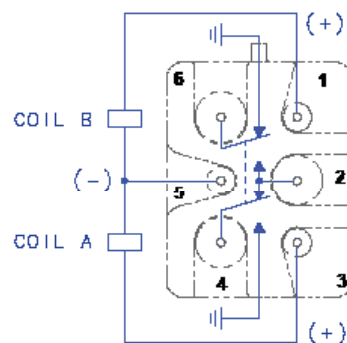
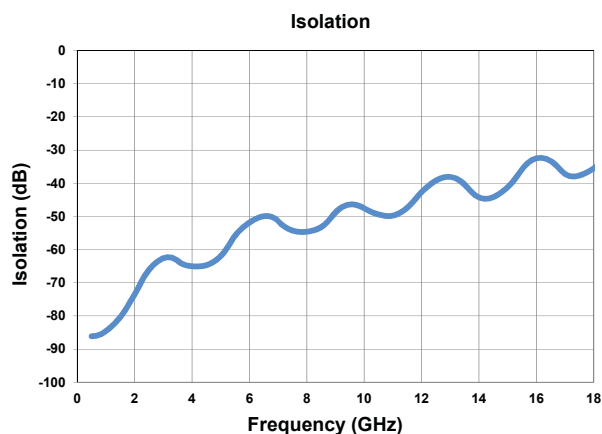
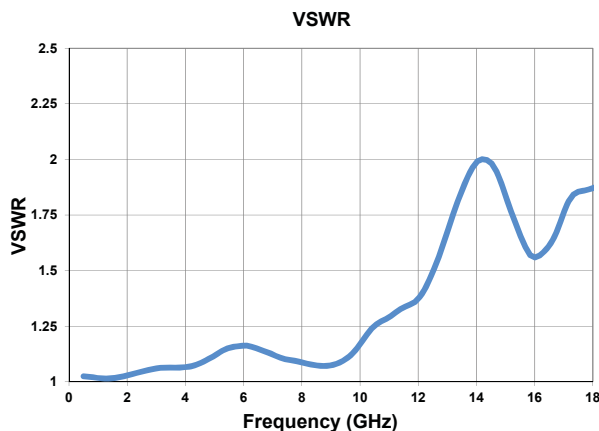
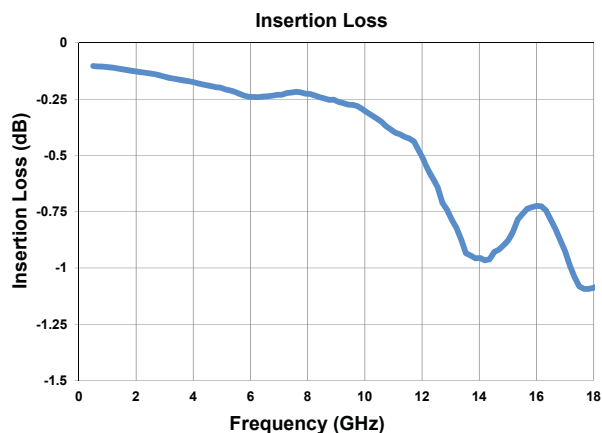

CONTACTS SHOWN IN POSITION RESULTING WHEN COIL A LAST ENERGIZED
Schematics as viewed from terminals

RF RELAYS

GRF121 @ 16Gbps

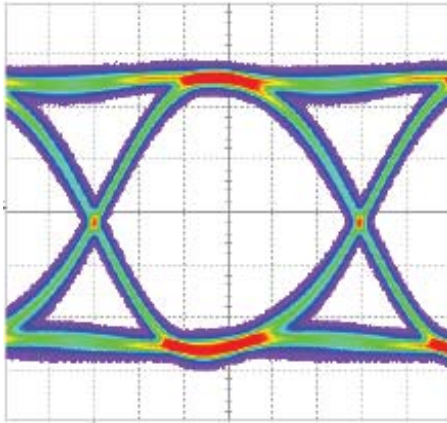

Bit Rate	Eye Height	Eye Width	Jitter _{P-P}
16 Gbps	203 mV	49.92 ps	4.99 ps

Reference @ 16Gbps

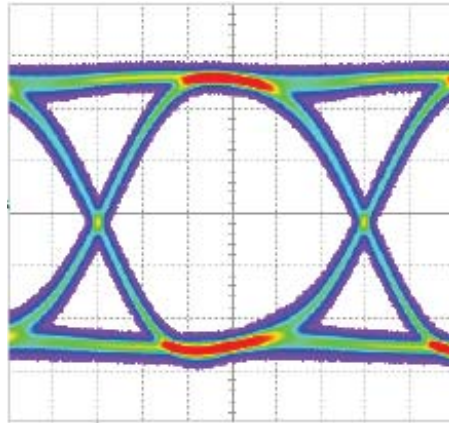

GRF121 @ 28Gbps

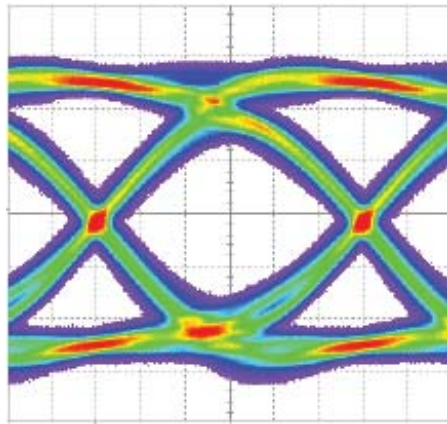

Bit Rate	Eye Height	Eye Width	Jitter _{P-P}
28 Gbps	139.2 mV	21.6 ps	5.89 ps

Reference @ 28Gbps

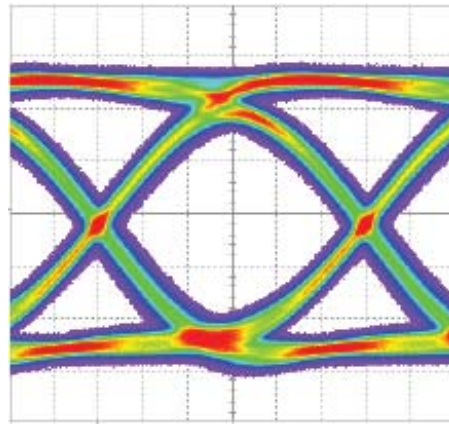

GRF121 @ 40Gbps

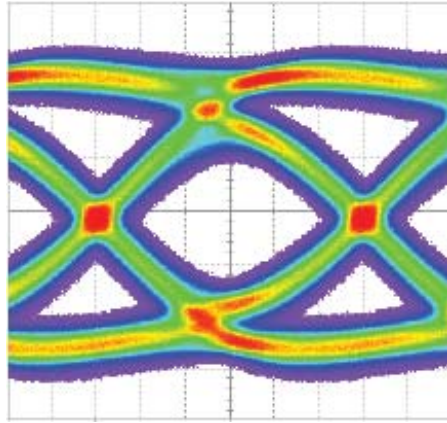

Bit Rate	Eye Height	Eye Width	Jitter _{P-P}
40 Gbps	95 mV	13.34 ps	8.73 ps

Reference @ 40Gbps

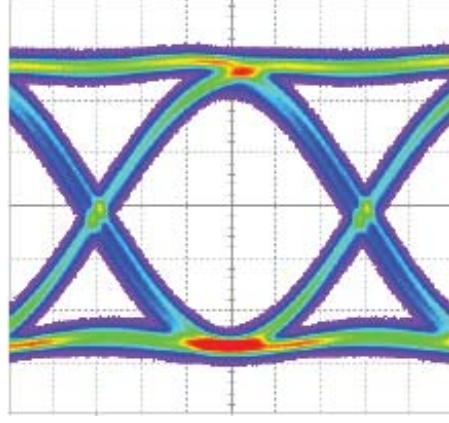

LOOPBACK RELAYS

Series LB363/GLB363/SGLB363 Electromechanical Relays

The LoopBack Series relays combines to DPDT electromechanical relays in one package that includes an internal bypass path for Automated Test Equipment (ATE) applications. The LoopBack combines the technology of two Teledyne SGRF303 Series relays and eliminates the need for external PCB traces in loop back applications. This innovation results in superior signal integrity and RF performance while taking minimal board space. The internal structure of the LoopBack relays reduces the number of discontinuities and shortens the signal path during loop back testing, providing lower insertion loss and higher signal integrity performance than two SGRF303 Series relays. This LoopBack Relay is available with surface mount ground shield and J-lead configuration to provide improved high data rate and high frequency performance and ease of surface mount attachment.

- Excellent Signal integrity up to 16Gbps
- Hermetically Sealed
- High Resistance to ESD
- Metal Enclosure for EMI shielding
- High Repeatability
- Broader bandwidth
- Through-hole or surface-mount configurations
- 5 Million Cycle Life

Relay Type
Two DPDT Relays
Capacitor Value
000 = No capacitor
010 = 10nF
100 = 100nF
220 = 220nF
Mounting
LB = Thru-hole
GLB = Surface-Mount
Ground Shield (Stub)
SGLB = Surface-Mount
Ground Shield(J-Lead)
Temperature
Storage: -65°C to +125°C
Operating: -55°C to +85°C

Part Number	LB363	GLB363	SGLB363
			
Voltage (Vdc)	5,12	5,12	5,12
Coil Resistance (Ω)	56, 400	56, 400	56, 400
Frequency (GHz)	DC-6	DC-6	DC-6

	AC Bypass Path (Thru-CAP)			Through Path			AC Bypass Path (Thru-CAP)			Through Path		
	Single-Ended Bit Rate @ 12 Gbps			Single-Ended Bit Rate @ 12 Gbps			Single-Ended Bit Rate @ 16 Gbps			Single-Ended Bit Rate @ 16 Gbps		
	Eye Height (mV)	Eye Width (ps)	Jitter p-p (ps)	Eye Height (mV)	Eye Width (ps)	Jitter p-p (ps)	Eye Height (mV)	Eye Width (ps)	Jitter p-p (ps)	Eye Height (mV)	Eye Width (ps)	Jitter p-p (ps)
LB363	289	75	8.53	385	70.5	10.67	170	46.0	16.44	262	49.8	11.33
GLB363	318	74.1	8.8	398	73.1	10.4	157	49.4	14.22	251	49.2	10.67
SGLB363	329	74.2	7.2	395	73	11.2	173	48.3	12.67	288	47.9	11.56

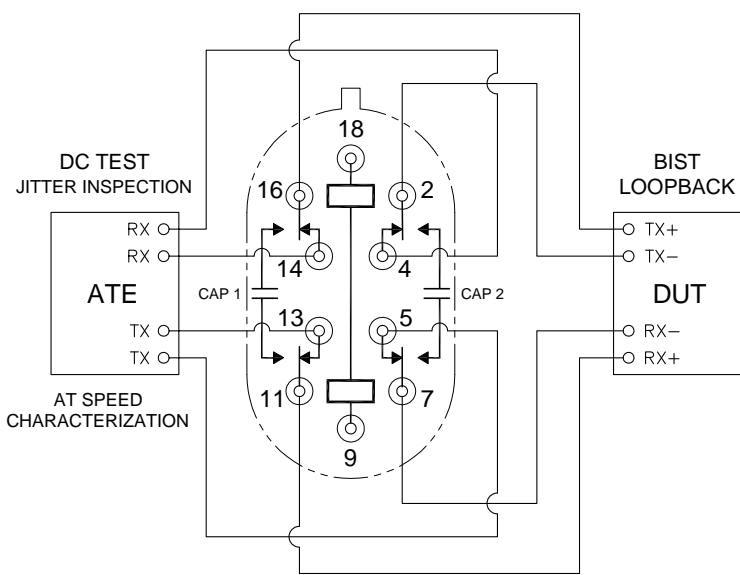

(Contacts shown in De-Energized position)

Figure 1: Single LoopBack Relay

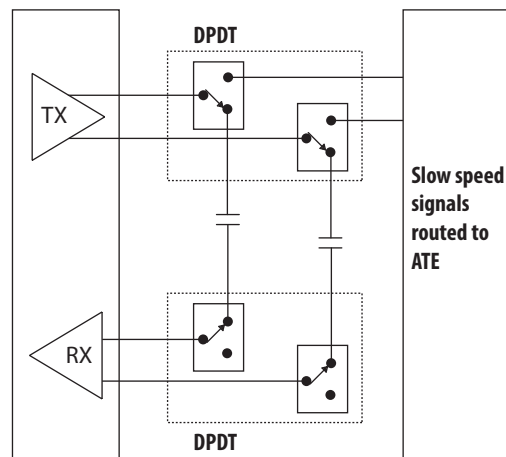
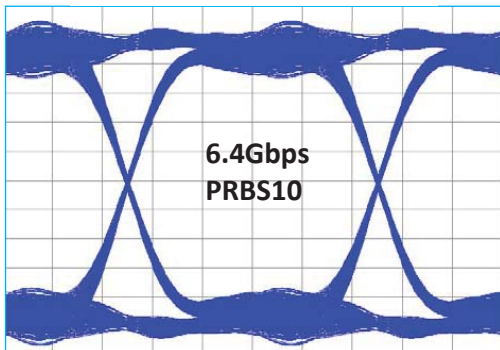

Figure 2: 2 DPDT Relays with external capacitors

LOOPBACK RELAYS

Dual SGRF303 Loopback



Single LB363 Loopback

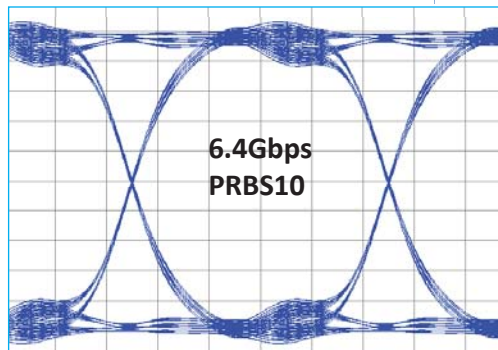

Dual SGRF303 Loopback

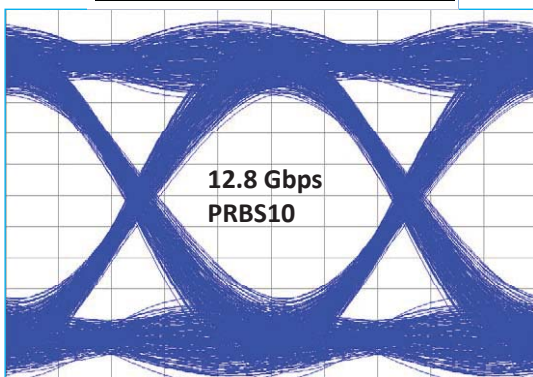

Single LB363 Loopback

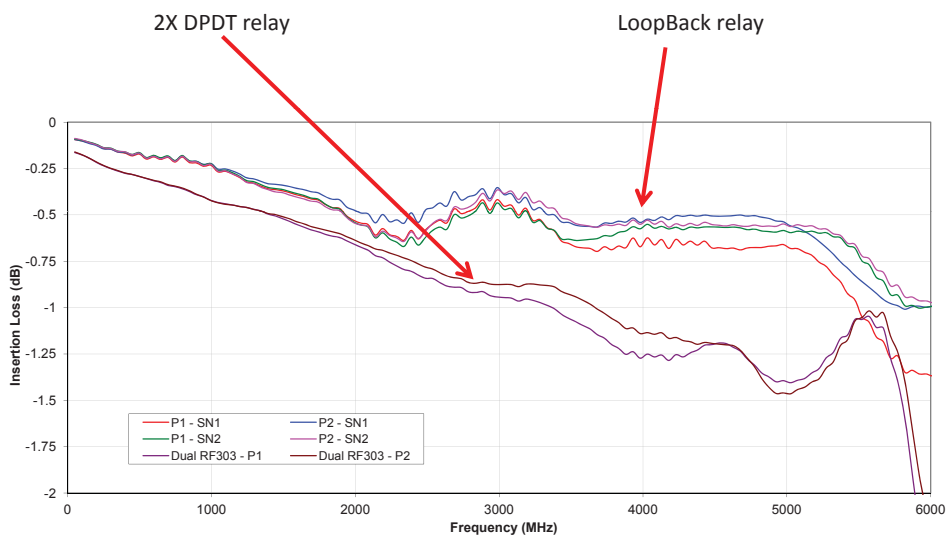
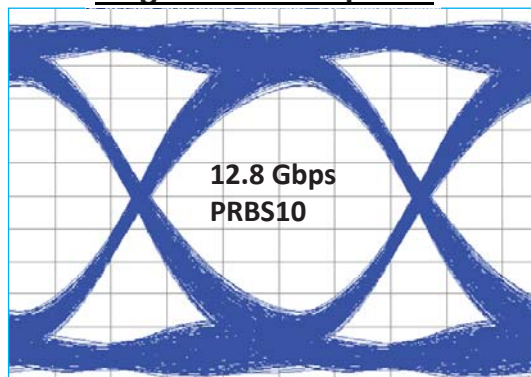

A single LB363 has better Insertion Loss performance than 2 SGRF303 relays in a LoopBack application

RF RELAYS

Series RF300/RF303 Electromechanical Relays





The RF300 and RF303 TO-5 relays are designed to provide improved RF signal repeatability over the frequency range. The RF300 Series is offered with a standard or sensitive coil.

The GRF300 and GRF303 TO-5 relays feature a unique ground shield that isolates and shields each lead to ensure excellent contact-to-contact and pole-to-pole isolation. This ground shield provides a ground interface that results in improved high-frequency performance as well as parametric repeatability.

The SGRF300 and SGRF303 TO-5 relays extend performance advantages over similar RF devices that simply offer formed leads for surface mounting.

- Excellent Signal integrity up to 18Gbps+
- Hermetically Sealed
- Metal Enclosure for EMI shielding
- High Repeatability
- Broader bandwidth
- Through-hole or surface-mount configurations
- 10 Million Cycle Life

Relay Type
DPDT Non-Latching
Coil Type
300 = Standard Coil 303 = Sensitive Coil
Diode Option
D = Internal diode for coil transient suppression DD = Internal diode for coil transient suppression and polarity reversal protection
Mounting
RF = Thru-hole GRF = Surface-Mount (Stub) SGRF = Surface-Mount (J-Lead) SRF = Surface Mount (J-Lead)
Temperature
Storage: -65°C to +125°C Operating: -55°C to +85°C

Part No.	Frequency (GHz)	VSWR (max)	Isolation (dB)		Insertion Loss (dB) (max)
			Pole to Pole (min)	Across Contacts (min)	
 RF300 RF300D	DC-1	1.1 : 1	30	25	0.2
	1-2	1.1 : 1	25	20	0.3
	2-3	1.2 : 1	25	20	0.4
 GRF300 GRF300D	DC-1	1.1 : 1	40	30	0.2
	1-3	1.1 : 1	40	30	0.2
	3-4	1.3 : 1	30	30	0.6
	4-6	1.6 : 1	25	25	1.0
 SGRF300 SGRF300D	DC-1	1.2 : 1	40	30	0.2
	1-3	1.2 : 1	40	30	0.4
	3-4	1.2 : 1	20	25	0.8
	4-6	1.8 : 1	10	20	1.0
 SRF300 SRF300D	DC-1	1.1 : 1	25	25	0.5
	1-3	1.5 : 1	25	25	0.5
	3-4	2.0 : 1	15	15	3.0
	4-6	2.5 : 1	10	10	4.0

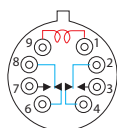

300
303

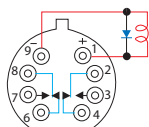

300D
303D

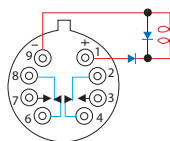

300DD
303DD

Part No.	Nominal Coil*	
	Voltage (Vdc)	Resistance (Ω)
 RF300 RF300D	5	50
	12	390
RF303 RF303D	5	100
	12	850

For RF300DD & RF303DD values, please see Datasheet.

*RF, GRF, SGRF and SRF have equivalent Voltage Options and Coil Resistance.

Schematics as viewed from terminals

RF RELAYS

16 Gbps

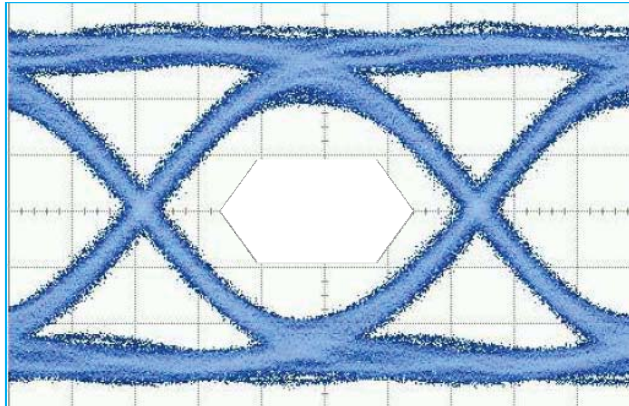

Eye Height	Eye Width	Jitter _{p-p}
248 mV	54.7 ps	8.0 ps

18 Gbps

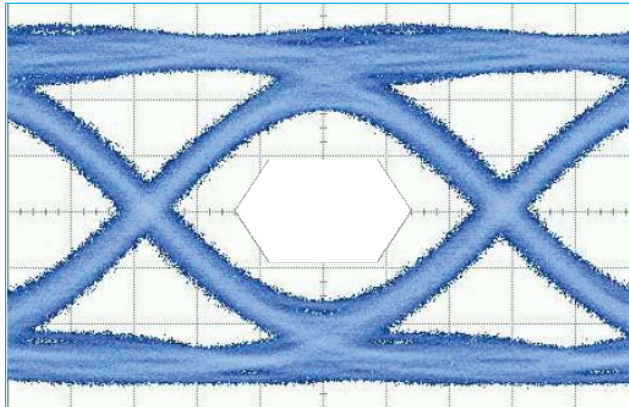

Eye Height	Eye Width	Jitter _{p-p}
193 mV	46.3 ps	10.67 ps

20 Gbps

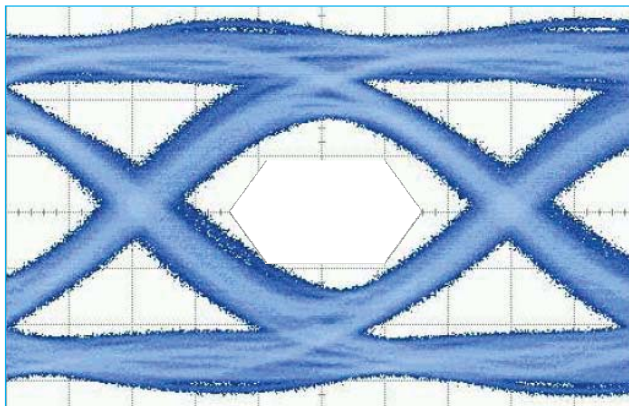

Eye Height	Eye Width	Jitter _{p-p}
157 mV	39.4 ps	14.4 ps

RF RELAYS

Series SI800/SI803 Electromechanical Relays

The miniature SI800/SI803 Series is designed for high-speed digital applications. They are capable of transmitting high-speed signals with data rates up to 20 Gbps. The SI800 series has a lower profile but higher coil operating power; whereas the SI803 Series has lower coil operating power but has a higher profile.

- Excellent Signal integrity up to 20Gbps
- High Repeatability
- Hermetically Sealed
- High Resistance to ESD
- Metal Enclosure for EMI shielding
- Ground pin option to improve case grounding
- 5 Million Cycle Life

Relay Type
DPDT Non-Latching
Coil Type
SI800= Standard Coil SI803 = Sensitive Coil
Temperature
Storage: -65°C to +125°C Operating: -55°C to +85°C

Part No.	Typical RF Performance				
	Frequency (GHz)	VSWR (max)	Isolation (dB)		Insertion Loss (dB) (max)
			Pole to Pole (min)	Across Contacts (min)	
 SI800 SI803	DC-1	1.1 : 1	30	25	0.2
	1-2	1.1 : 1	25	20	0.3
	2-3	1.2 : 1	25	20	0.4

Part No.	Nominal Coil	
	Voltage (Vdc)	Resistance (Ω)
 SI800	5	50
	12	390
SI803	5	100
	12	850

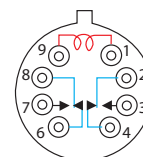

SI800
SI803

Schematics as viewed from terminals

SI800 Time Response

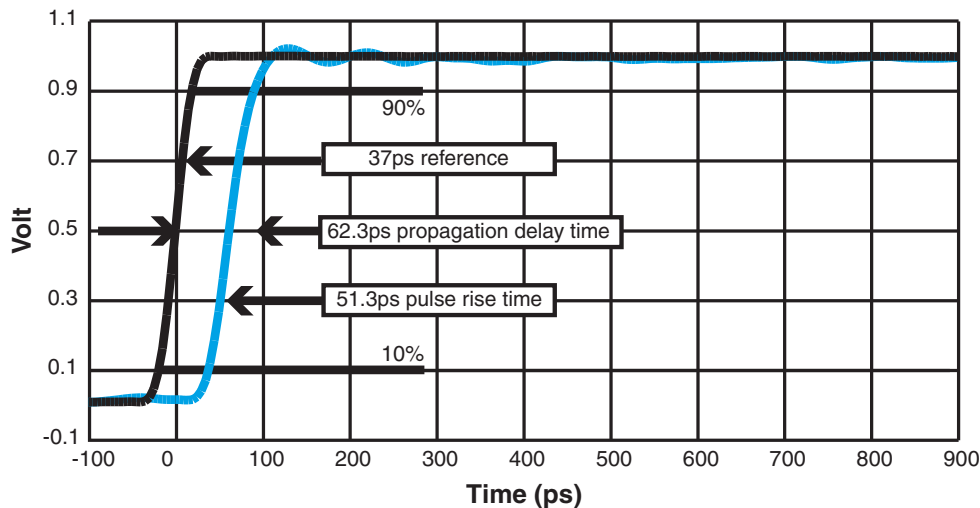

Data is the average from readings taken on all closed contacts.

RF RELAYS

16 Gbps

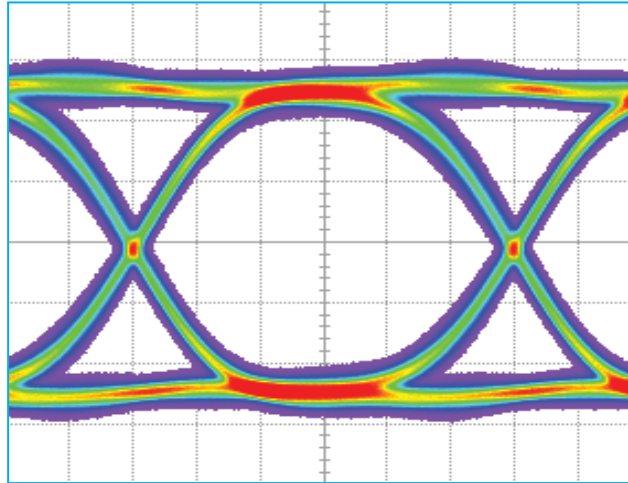

Eye Height	Eye Width	Jitter _{p,p}
296 mV	54.4 ps	8.22 ps

18 Gbps

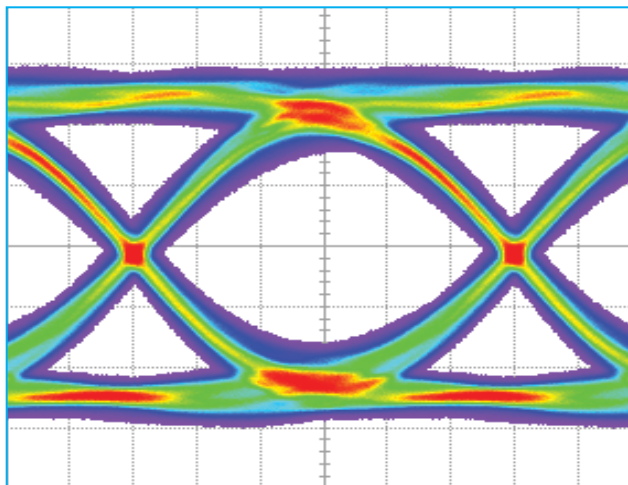

Eye Height	Eye Width	Jitter _{p,p}
252 mV	46.1 ps	9.11 ps

20 Gbps

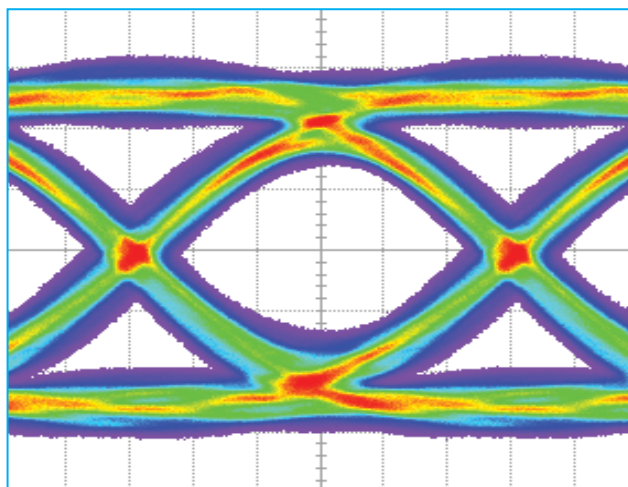

Eye Height	Eye Width	Jitter _{p,p}
191 mV	37 ps	10.22 ps

RF RELAYS

Series RF100/RF103 Electromechanical Relays

The RF100 and RF103 Centigrad® relays are designed to provide improved RF signal repeatability over the frequency range.

The GRF100 and GRF103 Centigrad® relays feature a unique ground shield that isolates and shields each lead to ensure excellent contact-to-contact and pole-to-pole isolation. This ground shield provides a ground interface that results in improved high-frequency performance as well as parametric repeatability.

The SGRF100 and SGRF103 Centigrad® relays extend performance advantages over similar RF devices that simply offer formed leads for surface mounting.

- Excellent Signal integrity up to 18Gbps
- Hermetically Sealed
- High Resistance to ESD
- Metal Enclosure for EMI shielding
- High Repeatability
- Broader bandwidth
- Through-hole or surface-mount configurations
- 10 Million Cycle Life

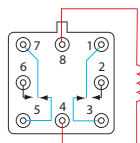

100
103

Relay Type
DPDT Non-Latching
Coil Type
100 = Standard Coil 103 = Sensitive Coil
RF100 Coil Voltage
5V: Coil Resistance (Ω) = 50 12V: Coil Resistance (Ω) = 390
RF103 Coil Voltage
5V: Coil Resistance (Ω) = 100 12V: Coil Resistance (Ω) = 800
Mounting
RF = Thru-hole GRF = Surface-Mount (Stub) SGRF = Surface-Mount (J-Lead)
Temperature
Storage: -65°C to $+125^{\circ}\text{C}$ Operating: -55°C to $+85^{\circ}\text{C}$

Part No.	Typical RF Performance				
	Frequency (GHz)	VSWR (max)	Isolation (dB)		Insertion Loss (dB) (max)
			Pole to Pole (min)	Across Contacts (min)	
 RF100 RF103	DC-1	1.1 : 1	35	25	0.2
	1-2	1.5 : 1	30	20	0.5
	2-3	1.6 : 1	30	20	0.6
 GRF100 GRF103	DC-1	1.1 : 1	45	30	0.2
	1-3	1.2 : 1	40	25	0.3
	3-4	1.3 : 1	35	25	0.6
 SGRF100 SGRF103	DC-1	1.2 : 1	35	30	0.2
	1-3	1.3 : 1	30	30	0.7
	3-4	1.4 : 1	25	25	0.8
	4-6	1.8 : 1	25	25	1.0

Series RF700/RF703 Electromechanical Relays

The ultraminiature RF700 and RF703 relays are designed to provide improved RF signal switching repeatability over the frequency range. These relays are engineered for use in RF attenuator, RF switch matrices, ATE and other applications that require dependable high frequency signal fidelity and performance.

The Series RF700/RF703 relays have internal discrete silicon diodes for coil suppression and polarity reversal protection. This hybrid package reduces required PC board floor space by reducing the number of external components needed to drive the relay

- Hermetically Sealed
- High Resistance to ESD
- Metal Enclosure for EMI shielding
- High Repeatability
- Broader bandwidth
- Through-hole or surface-mount configurations
- 5 Million Cycle Life

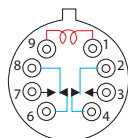

700
703

Relay Type
DPDT Non-Latching
Coil Type
700 = Standard Coil 703 = Sensitive Coil
Mounting
RF = Thru-hole GRF = Surface-Mount (Stub) SGRF = Surface-Mount (J-Lead)
Temperature
Storage: -65°C to $+125^{\circ}\text{C}$ Operating: -55°C to $+85^{\circ}\text{C}$

Part No.	Typical RF Performance				
	Frequency (GHz)	VSWR (max)	Isolation (dB)		Insertion Loss (dB) (max)
			Pole to Pole (min)	Across Contacts (min)	
 RF700 RF703	DC-1	1.1 : 1	30	25	0.2
	1-2	1.1 : 1	25	20	0.3
	2-3	1.2 : 1	25	20	0.4
	3-4	1.2 : 1	20	20	0.55

Part No.	Nominal Coil	
	Voltage (Vdc)	Resistance (Ω)
 RF700	5	50
	12	390
 RF703	5	100
	12	850

RF RELAYS

Series RF311/RF331 Electromechanical Relays



The RF311/RF331 relays are designed to provide improved RF signal repeatability over the frequency range.

These relays are highly suitable for use in attenuator and other RF circuits.

The GRF311 offers monotonic insertion loss to 8GHz. This improvement in RF insertion loss over the frequency range makes these relays highly suitable for use in attenuator and other RF circuits. The GRF311 features a unique ground shield that isolates and shields each lead to ensure excellent contact-to-contact isolation. This ground shield provides a ground interface that results in improved high-frequency performance as well as parametric repeatability.

- Excellent Signal integrity up to 10Gbps
- Hermetically Sealed
- High Resistance to ESD
- Metal Enclosure for EMI shielding
- High Repeatability
- Broader bandwidth
- Through-hole or surface-mount configurations
- 10 Million Cycle Life

Relay Type
SPDT Non-Latching
Coil Type
311 = Standard Coil 331 = Sensitive Coil
RF311 Coil Voltage
5V: Coil Resistance (Ω) = 50 12V: Coil Resistance (Ω) = 390 26V: Coil Resistance (Ω) = 2000
RF331 Coil Voltage
5V: Coil Resistance (Ω) = 125 12V: Coil Resistance (Ω) = 1025 26V: Coil Resistance (Ω) = 4000
Mounting
RF = Thru-hole GRF = Surface-Mount (Stub)
Temperature
Storage: -65°C to $+125^{\circ}\text{C}$ Operating: -55°C to $+85^{\circ}\text{C}$

Part No.	Typical RF Performance			
	Frequency (GHz)	VSWR (max)	Isolation Across Contacts (dB) (min)	Insertion Loss (dB) (max)
 RF311	DC-2	1.3 : 1	25	0.2
	2-4	1.6 : 1	20	0.4
	4-6	1.6 : 1	20	0.6
	6-8	1.6 : 1	15	0.8
 GRF311	DC-2	1.2 : 1	30	0.3
	2-4	1.5 : 1	25	0.5
	4-6	1.5 : 1	25	0.7
 RF331	DC-2	1.3 : 1	25	0.2
	2-4	1.6 : 1	20	0.4
	4-6	1.6 : 1	20	0.6
	6-8	1.6 : 1	15	0.8

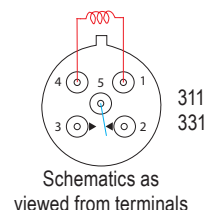



Series RF341 Electromechanical Relays

The RF341 series relay is an ultraminiature, hermetically sealed, magnetic-latching relay featuring extremely low intercontact capacitance for exceptional RF performance well into the C band. Its low profile and small size make it ideal for applications where extreme packaging density and/or close PC board spacing are required. Due to its minimal mass, many relays may be used to configure replacements for bulkier switching solutions at substantial savings in weight. The RF341 design has been optimized by increasing the distance between the set/reset contacts. This design improvement makes these unique relays the perfect choice for use in RF attenuators, RF switching matrices and other RF applications requiring high isolation, low insertion loss and low VSWR.

The GRF341 features a unique ground shield that isolates and shields each lead to ensure excellent contact-to-contact isolation. This ground shield provides a ground interface that results in improved high-frequency performance as well as parametric repeatability.

- Excellent Signal integrity up to 10Gbps
- Hermetically Sealed
- High Resistance to ESD
- Metal Enclosure for EMI shielding
- High Repeatability
- Broader bandwidth
- Through-hole or surface-mount configurations
- 10 Million Cycle Life

Relay Type
SPDT Magnetic-Latching
Coil Type
341 = Standard Coil
RF341 Coil Voltage
5V: Coil Resistance (Ω) = 61 12V: Coil Resistance (Ω) = 500 26V: Coil Resistance (Ω) = 2000
Mounting
RF = Thru-hole GRF = Surface-Mount (Stub)
Temperature
Storage: -65°C to $+125^{\circ}\text{C}$ Operating: -55°C to $+85^{\circ}\text{C}$

Part No.	Typical RF Performance			
	Frequency (GHz)	VSWR (max)	Isolation Across Contacts (dB) (min)	Insertion Loss (dB) (max)
 RF341	DC-2	1.2 : 1	30	0.5
	2-4	1.2 : 1	25	0.8
	4-6	1.4 : 1	20	2.0
 GRF341	DC-2	1.2 : 1	35	0.3
	2-4	1.3 : 1	30	0.7
	4-6	1.4 : 1	25	1.5

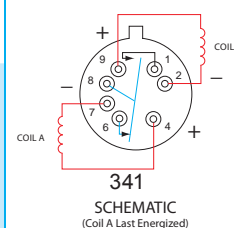

Schematics as viewed from terminals

RF RELAYS

Series RF255/RF257 Electromechanical Relays

The Series RF255/257 The Series RF255 is an industry-standard, half-size, latching crystal can relay. These relays are highly suitable for high RF power applications (RF Power Handling) and other RF circuits. Teledyne Relays' Series RF255 offers: all welded construction, wire leads, gold-plated or solder-coated, matched seal for superior hermeticity, gold-plated contact assembly, modernized assembly process and advanced cleaning techniques.

- Excellent Signal integrity up to 10Gbps
- Hermetically Sealed
- High Resistance to ESD
- Metal Enclosure for EMI shielding
- High Repeatability
- Broader bandwidth
- Through-hole or surface-mount configurations
- 1 Million Cycle Life

Relay Type
DPDT Magnetic-Latching
Mounting
RF = Thru-hole
RF255 Coil Voltage
5V: Coil Resistance (Ω) = 45
6V: Coil Resistance (Ω) = 63
12V: Coil Resistance (Ω) = 254
26V: Coil Resistance (Ω) = 1000
Temperature
Storage: -65°C to $+125^{\circ}\text{C}$
Operating: -55°C to $+85^{\circ}\text{C}$

Part No.	Typical RF Performance				
	Frequency (GHz)	VSWR (max)	Isolation (dB)		Insertion Loss (dB) (max)
			Pole to Pole (min)	Across Contacts (min)	
 RF255 RF257	DC-1	1.10:1	40	25	0.3
	1-2	1.60:1	35	20	0.6
	2-3	1.90:1	30	20	0.8

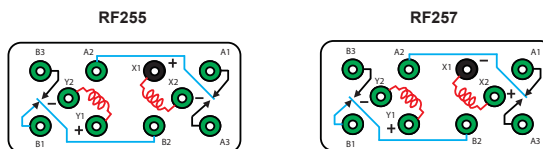

SCHEMATIC
(Coil X Last Energized)
(Bottom View)

Series GRF342 Electromechanical Relays

The Series GRF342 relay is a hermetically sealed, RF relay designed from inception for surface mount applications. This magnetic-latching relay features extremely low internal circuit losses for exceptional time and frequency domain response characteristics through and beyond the UHF spectrum and into the S band. The GRF342 features a unique ground shield that isolates and shields each lead to ensure excellent contact-to-contact and pole-to-pole isolation. This ground shield provides an RF ground interface that results in improved high-frequency performance as well as parametric repeatability. The GRF342 extends performance advantages over similar RF devices that simply offer formed leads for surface mounting.

- Excellent Signal integrity up to 10Gbps
- Hermetically Sealed
- High Resistance to ESD
- Metal Enclosure for EMI shielding
- High Repeatability
- Broader bandwidth
- Through-hole or surface-mount configurations
- 10 Million Cycle Life

Relay Type
DPDT Magnetic-Latching
Coil Type
342 = Standard Coil
RF342 Coil Voltage
5V: Coil Resistance (Ω) = 61
12V: Coil Resistance (Ω) = 500
Mounting
GRF = Surface-Mount (Stub)
Temperature
Storage: -65°C to $+125^{\circ}\text{C}$
Operating: -55°C to $+85^{\circ}\text{C}$

Part No.	Typical RF Performance				
	Frequency (GHz)	VSWR (max)	Isolation (dB)		Insertion Loss (dB) (max)
			Pole to Pole (min)	Across Contacts (min)	
 GRF342	DC-2	1.1 : 1	40	35	0.3
	2-4	1.2 : 1	30	30	0.4
	4-6	1.4 : 1	25	25	0.8

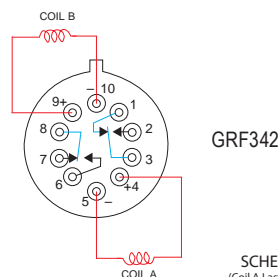

Schematics as viewed from terminals

RF RELAYS

Series RF180/GRF180 Electromechanical Relays

The Series RF180 relay is a hermetically sealed, magnetic-latching relay featuring extremely low intercontact capacitance for exceptional RF performance over the full UHF spectrum. Its low profile height and .100" (2.54 mm) grid spaced terminals make it ideal for applications where extreme packaging density and/or close PC board spacing are required.

The GRF180 features a unique ground shield that isolates and shields each lead to ensure excellent contact-to-contact and pole-to-pole isolation. This ground shield provides a ground interface that results in improved high-frequency performance as well as parametric repeatability.

- Excellent Signal integrity up to 10Gbps
- Hermetically Sealed
- High Resistance to ESD
- Metal Enclosure for EMI shielding
- High Repeatability
- Broader bandwidth
- Through-hole or surface-mount configurations
- 10 Million Cycle Life

Relay Type
DPDT Magnetic-Latching
Coil Type
180 = Standard Coil
RF180 Coil Voltage
5V: Coil Resistance (Ω) = 61 12V: Coil Resistance (Ω) = 500 26V: Coil Resistance (Ω) = 2000
Mounting
RF = Thru-hole GRF = Surface-Mount (Stub)
Temperature
Storage: -65°C to $+125^{\circ}\text{C}$ Operating: -55°C to $+85^{\circ}\text{C}$

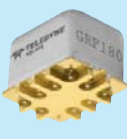
Part No.	Typical RF Performance				
	Frequency (GHz)	VSWR (max)	Isolation (dB)		Insertion Loss (dB) (max)
			Pole to Pole (min)	Across Contacts (min)	
 RF180	DC-2	1.3 : 1	50	30	0.2
	2-4	1.3 : 1	45	30	0.3
	4-6	2.0 : 1	30	25	1.5
 GRF180	DC-2	1.2 : 1	50	35	0.2
	2-4	1.3 : 1	35	30	0.4
	4-6	2.0 : 1	25	30	1.5

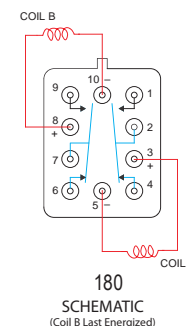

Schematics as viewed from terminals

Series GRF172 Electromechanical Relays

The GRF172 Centigrd® relay is a hermetically sealed, armature relay for 2.5GHz RF applications. Its low profile height .330" (8.38 mm) and .100" (2.54 mm) grid spaced terminals make it an ideal choice where extreme packaging density and/or close PC board spacing are required. The GRF172 features a unique ground shield that isolates and shields each lead to ensure excellent contact-to-contact and pole-to-pole isolation. This ground shield provides a ground interface that results in improved high-frequency performance as well as parametric repeatability. The GRF172 extends performance advantages over similar RF devices that simply offer formed leads for surface mounting.

The Series GRF172D has an internal discrete silicon diode for coil suppression.

- Excellent Signal integrity up to 10Gbps
- Hermetically Sealed
- High Resistance to ESD
- Metal Enclosure for EMI shielding
- High Repeatability
- Broader bandwidth
- Through-hole or surface-mount configurations
- 5 Million Cycle Life

Relay Type
DPDT Non-Latching
Coil Type
172 = Standard Coil
RF172Coil Voltage
5V: Coil Resistance (Ω) = 64 12V: Coil Resistance (Ω) = 400 26V: Coil Resistance (Ω) = 1600
Diode Option
D = Internal diode for coil transient suppression
Mounting
GRF = Surface-Mount (Stub)
Temperature
Storage: -65°C to $+125^{\circ}\text{C}$ Operating: -55°C to $+85^{\circ}\text{C}$

Part No.	Typical RF Performance				
	Frequency (GHz)	VSWR (max)	Isolation (dB)		Insertion Loss (dB) (max)
			Pole to Pole (min)	Across Contacts (min)	
 GRF172	DC-1	1.1 : 1	45	30	0.2
	1-2	1.2 : 1	40	25	0.3
	2-2.5	1.2 : 1	40	25	0.3

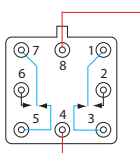

GRF172

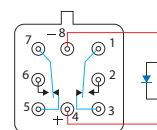

GRF172D

Schematics as viewed from terminals



RF RELAYS

Series RF424/GRF424/SGRF424 Electromechanical Relays

The Series RF424/GRF424/SGRF424 relay is an ultraminiature, hermetically sealed, magnetic-latching relay featuring low intercontact capacitance for exceptional RF performance from DC-8 GHz. Its low profile and small size make it ideal for applications where extreme packaging density and/or close PC board spacing are required. The RF424 Series features a unique ground shield that isolates and shields each lead to ensure excellent contact-to-contact and pole-to-pole isolation. This ground shield provides a ground interface that results in improved high-frequency performance as well as parametric repeatability.

- Excellent Signal integrity up to 10Gbps
- Hermetically Sealed
- High Resistance to ESD
- Metal Enclosure for EMI shielding
- High Repeatability
- Broader bandwidth
- Through-hole or surface-mount configurations
- 10 Million Cycle Life

Relay Type
4PST Magnetic-Latching
Coil Type
424 = Standard Coil
RF424 Coil Voltage
5V: Coil Resistance (Ω) = 61
12V: Coil Resistance (Ω) = 500
26V: Coil Resistance (Ω) = 2000
Mounting
RF = Thru-hole
GRF = Surface-Mount (Stub)
SGRF = Surface-Mount (J-Lead)
Temperature
Storage: -65°C to $+125^{\circ}\text{C}$
Operating: -55°C to $+85^{\circ}\text{C}$

Part No.	Typical RF Performance				
	Frequency (GHz)	VSWR (max)	Isolation (dB)		Insertion Loss (dB) (max)
			Pole to Pole (min)	Across Contacts (min)	
 RF424 RF424D	DC-2	1.10:1	50	30	0.2
	2-4	1.20:1	40	20	0.3
	4-6	1.30:1	30	15	0.4
	6-8	1.60:1	25	15	0.6
 GRF424 GRF424D	Contact Factory				
 SGRF424 SGRF424D	Contact Factory				

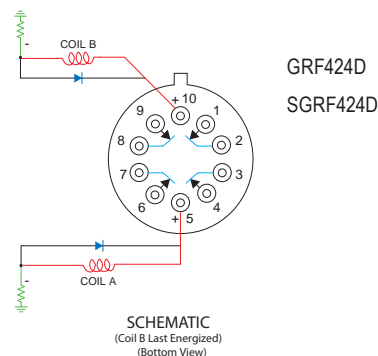
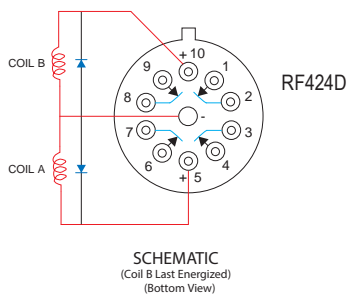
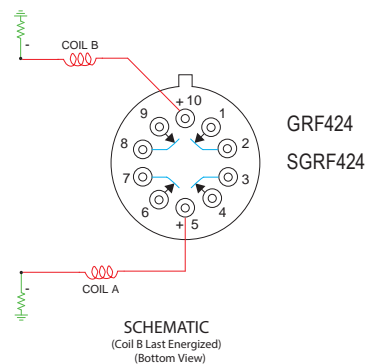
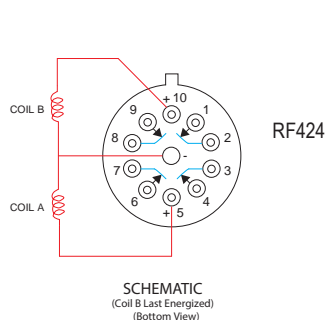

Schematics as viewed from terminals
For GRF424 and SGRF424 case to be grounded

RF RELAYS

Series RF310/RF313 Electromechanical Relays

The ultraminiature RF310 and RF313 relays are designed with an internal bypass (through path), when the coil is de-energized, to provide low insertion loss and VSWR through the bypass and simplicity of design for the user. Relays have improved RF insertion loss repeatability over the frequency range from DC to 3 GHz. Highly suitable for use in attenuator, linear amplifier and other RF circuits.



- N.C. bypass configuration
- Repeatable insertion loss
- Broad Bandwidth

- Metal Enclosure for EMI shielding
- Ground pin option to improve ground case RF grounding
- High isolation between control and signal path
- 10 Million Cycle Life

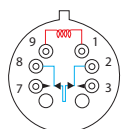
Relay Type
Normally Closed Bypass
Coil Type
310 = Standard Coil
313 = Sensitive Coil
Mounting
RF = Thru-hole
Temperature
Storage: -65°C to +125°C
Operating: -55°C to +85°C



RF310
RF313

Part No.	Nominal Coil		Typical RF Performance						
	Voltage (Vdc)	Resistance (Ω)	Frequency (GHz)	VSWR		Isolation (dB)		Insertion Loss (dB)	
				N.O. (max)	Bypass (max)	N.O. (min)	Bypass (min)	N.O. (max)	Bypass (max)
 RF310	5	50	DC-1	1.2 : 1	1.3 : 1	35	25	0.2	0.3
	12	390	1-2	1.2 : 1	1.3 : 1	25	25	0.3	0.4
			2-3	1.4 : 1	1.3 : 1	25	20	0.4	0.5
 RF313	5	100	DC-1	1.2 : 1	1.3 : 1	35	25	0.2	0.3
	12	850	1-2	1.2 : 1	1.3 : 1	25	25	0.3	0.4
			2-3	1.5 : 1	1.3 : 1	25	20	0.5	0.4

Series RF320/RF323 Electromechanical Relays

The ultraminiature RF320 and RF323 relays are designed with an internal bypass (through path), when the coil is energized, to provide low insertion loss and VSWR through the bypass and simplicity of design for the user. The RF320 and RF323 relays have improved RF insertion loss repeatability over the frequency range from DC to 3 GHz. Highly suitable for use in attenuator, linear amplifier and other RF circuits.



- N.O. bypass configuration
- Repeatable insertion loss
- Broad Bandwidth

- Metal Enclosure for EMI shielding
- Ground pin option to improve ground case RF grounding
- High isolation between control and signal path
- 10 Million Cycle Life

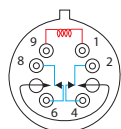
Relay Type
Normally Open Bypass
Coil Type
320 = Standard Coil
323 = Sensitive Coil
Mounting
RF = Thru-hole
Temperature
Storage: -65°C to +125°C
Operating: -55°C to +85°C



RF320
RF323

Part No.	Nominal Coil		Typical RF Performance						
	Voltage (Vdc)	Resistance (Ω)	Frequency (GHz)	VSWR		Isolation (dB)		Insertion Loss (dB)	
				N.C. (max)	Bypass (max)	N.C. (min)	Bypass (min)	N.C. (max)	Bypass (max)
 RF320	5	50	DC-1	1.2 : 1	1.4 : 1	30	25	0.2	0.4
	12	390	1-2	1.2 : 1	1.4 : 1	30	20	0.3	0.4
			2-3	1.4 : 1	1.4 : 1	25	20	0.4	0.6
 RF323	5	100	DC-1	1.2 : 1	1.4 : 1	30	25	0.2	0.4
	12	850	1-2	1.2 : 1	1.4 : 1	30	20	0.3	0.4
			2-3	1.4 : 1	1.4 : 1	25	20	0.4	0.5

Schematics as viewed from terminals

RF RELAYS

Series A150 Electromechanical Relays

The Series A150 ultraminiature Attenuator Relays are designed for attenuating RF signals in 50-ohm systems over a frequency range from DC to 3 GHz. Their low profile and small grid spacing makes them ideal for use when packaging density is a prime consideration. The A150 relays eliminate the need for additional external resistors.

These single section, switchable attenuator relays have internal matched thin film attenuator pads in "L," "T" or "Pi" configurations, as applicable. Relays are available in fixed increments of 1, 2, 3, 4, 5, 6, 8, 10, 16 and 20 dB, which can be used singly or in combination to achieve the attenuation levels desired.

The GA150 features a unique ground shield that isolates and shields each lead to ensure excellent contact-to-contact isolation. This ground shield provides a ground interface that results in improved high-frequency performance as well as parametric repeatability.

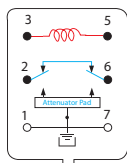

- Excellent phase linearity
- Hermetically Sealed
- High Resistance to ESD
- Metal Enclosure for EMI shielding
- High Repeatability
- Broader bandwidth
- Through-hole or surface-mount configurations
- 10 Million Cycle Life

Relay Type
RF Attenuator
Coil Type
A150 = Standard Coil
Mounting
A = Thru-hole GA = Surface-Mount (Stub)
Temperature
Storage: -65°C to +125°C Operating: -55°C to +85°C



150

SCHEMATIC
(Bottom View)

Part No.	Nominal Coil		Frequency (GHz)	Typical RF Performance			
	Voltage (Vdc)	Resistance (Ω)		VSWR		Insertion Loss (dB)	
				Attenuated Path (Typ.)	Thru Path (Max.)	Typ.	Max.
 A150	5	50	DC-1	1.20 : 1	1.10 : 1	0.1	0.25
	12	390	1-2	1.30 : 1	1.20 : 1	0.2	0.35
	15	610	2-3	1.40 : 1	1.25 : 1	0.3	0.55
	26	1560					
 GA150	5	50	DC-1	1.20 : 1	1.20 : 1	0.1	0.25
	12	390	1-2	1.20 : 1	1.20 : 1	0.2	0.35
	15	610	2-3	1.20 : 1	1.30 : 1	0.3	0.45
	26	1560					

Series A152 Electromechanical Relays

The Series A152 highly repeatable ultraminiature attenuator relays are designed for attenuating RF signals in 50-ohm systems over a frequency range from DC to 5 GHz. Their low profile and small grid spacing makes them ideal for use when packaging density is a prime consideration. The A152 relays eliminate the need for additional external resistors/attenuators.

These single section, switchable attenuator relays have an internal matched thin film attenuator pad in a "Pi" configuration. Relays are available in a fixed increment of 20 dB. (Other values available)

The GA152 features a unique ground shield that isolates and shields each lead to ensure excellent contact-to-contact isolation. This ground shield provides a ground interface that results in improved high-frequency performance as well as parametric repeatability.

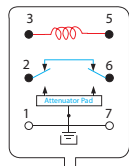

- Hermetically Sealed
- High Resistance to ESD
- Metal Enclosure for EMI shielding
- High Repeatability
- Broader bandwidth
- Through-hole or surface-mount configurations
- 10 Million Cycle Life

Relay Type
RF Attenuator
Coil Type
A152 = Standard Coil
Mounting
A = Thru-hole GA = Surface-Mount (Stub)
Temperature
Storage: -65°C to +125°C Operating: -55°C to +85°C



152

SCHEMATIC
(Bottom View)

Part No.	Nominal Coil		Frequency (GHz)	Typical RF Performance			
	Voltage (Vdc)	Resistance (Ω)		VSWR		Insertion Loss (dB)	
				Attenuated Path (Typ.)	Thru Path (Max.)	Typ.	Max.
 A152	5	50	DC-1	1.20 : 1	1.10 : 1	0.1	0.25
	12	390	1-2	1.30 : 1	1.20 : 1	0.2	0.35
	15	610	2-3	1.40 : 1	1.25 : 1	0.3	0.55
	26	1560	3-5	See Datasheet			
 GA152	5	50	DC-1	1.20 : 1	1.20 : 1	0.1	0.25
	12	390	1-2	1.20 : 1	1.20 : 1	0.2	0.35
	15	610	2-3	1.20 : 1	1.30 : 1	0.3	0.45
	26	1560	3-5	1.40 : 1	1.70 : 1	0.4	0.55

COMMERCIAL RELAYS

Series 122C Electromechanical Relays

The 122C Centigrad® magnetic-latching relay is an ultraminiature, hermetically sealed, armature relay capable of being directly driven by most IC logic families. Its low profile height and .100" (2.54 mm) grid spaced terminals, which precludes the need for spreader pads, make it ideal for applications where extreme packaging density and/or close PC board spacing are required.

The basic operating function and internal structure are similar to Teledyne's TO-5, 422 relay series. The 122C is capable of meeting Teledyne Relays' T2R® requirements.

The Series 122C relay has internal silicon diodes for coil suppression, Zener diodes to protect the MOSFET gate inputs, and N-channel enhancement-mode MOSFET chips, which enable direct relay interfacing with most microprocessor and IC logic families (CMOS, TTL and MOS).

The 122C magnetic-latching relay is ideally suited for applications where coil operating power must be minimized. The relays can be operated with a short-duration pulse. After the contacts have transferred, no external coil power is required.

The magnetic-latching feature of the Series 122C relay provides a "memory" capability, since the relays will not reset upon removal of coil power.

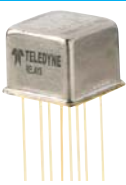
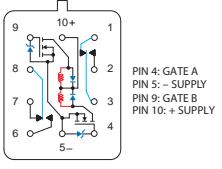

- All welded construction
- Unique uni-frame design providing high magnetic efficiency and mechanical rigidity
- High force/mass ratio for resistance to shock and vibration
- Precious metal alloy contact material with gold plating assures excellent high current and dry circuit switching capabilities
- 10 Million Cycle Life

Relay Type		Part No.	Nominal Coil				Contact Load Rating	
DPDT Magnetic-Latching			Voltage (Vdc)	Coil Current (mA)		Operating Power (mW)		Latch and Reset Voltage (Vdc) (Max)
CMOS Feature				Min.	Max.			
Internal power MOSFET driver and diode coil suppression		 122C	5	82.2	114.9	505	3.5	Resistive: 1A/28Vdc Inductive: 200mA/28Vdc (320mH) Lamp: 100mA/28Vdc Low Level: 10 to 50 uA/10 to 50 mV
Vibration			6	41.6	57.0	296	4.5	
Shock			9	27.4	37.2	288	6.8	
30 g's			12	20.5	27.8	287	9.0	
100 g's 6 msec, half-sine			18	13.7	18.2	286	13.5	
26			26	11.4	15.2	351	18.0	
Acceleration		 <p>PIN 4: GATE A PIN 5: - SUPPLY PIN 9: GATE B PIN 10: + SUPPLY</p> <p>122C</p> <p>SCHEMATIC (Coil A Last Energized)</p>						
50 g's								
Temperature								
Storage: -65°C to +125°C								
Operating: -55°C to +85°C								

Series 172 Electromechanical Relays

The 172 Centigrad® relay is an ultraminiature, hermetically sealed, armature relay for commercial applications. Its low profile height .280" (7.11 mm) and .100" (2.54 mm) grid spaced terminals, which preclude the need for spreader pads, make it an ideal choice where extreme packaging density and/or close PC board spacing are required. The Series 172 relay has an internal discrete silicon diode for coil transient suppression. By virtue of its inherently low intercontact capacitance and contact circuit losses, the 172 relay is an excellent subminiature RF switch for frequencies well into the UHF spectrum. Applications include telecommunications, test instruments, mobile communications, attenuators, and automatic test equipment.

- All welded construction
- Unique uni-frame design providing high magnetic efficiency and mechanical rigidity
- High force/mass ratio for resistance to shock and vibration
- Precious metal alloy contact material with gold plating assures excellent high current and dry circuit switching capabilities
- 5 Million Cycle Life

Relay Type		Part No.	Nominal Coil				Contact Load Rating
DPDT Non-Latching			Voltage (Vdc)	Resistance (Ω)	P.U.V (Vdc) (max.)	Operating Power (mW)	
Diode Options							
D = Internal diode for coil transient suppression		 172 172D	3	39	2.25	235	Resistive: 1A/28Vdc Inductive: 200mA/28Vdc (320mH) Lamp: 100mA/28Vdc Low Level: 10 to 50 uA/10 to 50 mV
Vibration			5	64	3.8	405	
Shock			12	400	9.0	360	
10 g's to 500 Hz			26	1600	18.0	440	
30 g's 6 msec, half-sine		 <p>172 172D</p>					
Temperature							
Storage: -65°C to +125°C							
Operating: -55°C to +85°C							

Schematics as viewed from terminals

P.U.V = Pick-Up Voltage

COMMERCIAL RELAYS

Series 712 Electromechanical Relays

The TO-5 relay, originally conceived and developed by Teledyne, has become one of the industry standards for low-level switching from dry circuit to 1 ampere. Designed for high-density PC board mounting, the Series 712 relays are some of the most versatile ultraminiature relays available because of their small size and low coil power dissipation.

The Series 712D relay has an internal discrete silicon diode for coil transient suppression. The hybrid Series 712TN relay has an internal silicon diode and transistor driver. The integrated packaging of the relay with its associated semiconductor devices greatly reduces PC board floor space requirements as well as component installation costs.

By virtue of its inherently low intercontact capacitance and contact circuit losses, the 712 has proven to be excellent ultraminiature RF switch for frequency ranges well into the UHF spectrum. A typical RF application for the TO-5 relay is in handheld radio transceivers, wherein the combined features of good RF performance, small size, low coil power dissipation and high reliability make it a preferred method of Transmit-Receive switching.

- All welded construction
- Unique uni-frame design providing high magnetic efficiency and mechanical rigidity
- High force/mass ratio for resistance to shock and vibration
- Precious metal alloy contact material with gold plating assures excellent high current and dry circuit switching capabilities
- 10 Million Cycle Life

Relay Type		Part No.	Nominal Coil				Contact Load Rating
DPDT Non-Latching			Voltage (Vdc)	Resistance (Ω)	P.U.V (Vdc) (max.)	Base Current to Turn On (712 TN only)	
Diode Options		 712 712D 712TN	5	50	3.6	3.00	Resistive: 1A/28Vdc Inductive: 200mA/28Vdc (320mH) Lamp: 100mA/28Vdc Low Level: 10 to 50 uA/10 to 50 mV
D = Internal diode for coil transient suppression			6	98	4.2	2.04	
TN = Internal transistor driver and coil transient suppression diode			9	220	6.5	1.36	
Vibration			12	390	8.4	1.03	
Shock			18	880	13.0	0.68	
10 g's to 500 Hz		26	1560	17.0	0.50		
Temperature							
Storage: -65°C to +125°C							
Operating: -55°C to +85°C							

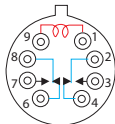

712

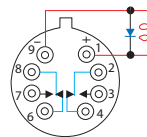

712D

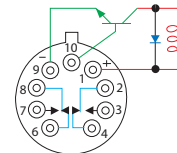

712TN

Schematics as viewed from terminals

Series 722 Electromechanical Relays

The magnetic-latching TO-5 relay, originally conceived and developed by Teledyne, has become one of the industry standards for low-level switching from dry circuit to 1 ampere. Designed for high-density PC board mounting, the 722 relay has become one of the most versatile ultraminiature relays available because of its small size and low coil power dissipation. The Series 722D relay has discrete silicon diodes for coil transient suppression. The Series 722 magnetic-latching relays are ideally suited for applications where coil power dissipation must be minimized. The relays can be operated with a short duration pulse and after the contacts have transferred, no external coil power is required. The magnetic-latching feature of the Series 722 provides a "memory" capability, since the relays will not reset upon removal of coil power.

- All welded construction
- Unique uni-frame design providing high magnetic efficiency and mechanical rigidity
- High force/mass ratio for resistance to shock and vibration
- Precious metal alloy contact material with gold plating assures excellent high current and dry circuit switching capabilities
- 10 Million Cycle Life

Relay Type		Part No.	Nominal Coil			Contact Load Rating
DPDT Magnetic-Latching			Voltage (Vdc)	Resistance (Ω)	Set & Reset Voltage (Vdc)	
Diode Options		 722 722D	5	61	3.5	Resistive: 1A/28Vdc Inductive: 200mA/28Vdc (320mH) Lamp: 100mA/28Vdc Low Level: 10 to 50 uA/10 to 50 mV
D = Internal diode for coil transient suppression			6	120	4.5	
Vibration			9	280	6.8	
Shock			12	500	9.0	
10 g's to 500 Hz			18	1130	13.5	
		26	2000	18.0		

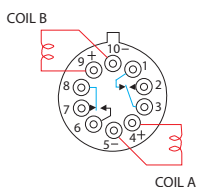

722

COIL A

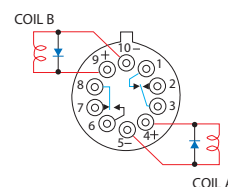

722D

COIL A

SCHEMATIC
(Coil A Last Energized)
(Bottom View)

SCHEMATIC
(Coil A Last Energized)
(Bottom View)

COMMERCIAL RELAYS

Series 732 Electromechanical Relays

The TO-5 relay, originally conceived and developed by Teledyne, has become one of the industry standards for low-level switching from dry circuit to 1 ampere. Designed for high-density PC board mounting, the Series 732 relay is one of the most versatile ultraminiature relays available because of their small size and low coil power dissipation. The sensitive 732 relay has a high resistance coil, thus requiring extremely low operating power (200 mW typical). The advantages of reduced heat dissipation and power supply demands are a plus.

The Series 732D relay has an internal discrete silicon diode for coil transient suppression. The hybrid Series 732TN relay has an internal silicon diode and transistor driver. The integrated packaging of the relay with its associated semiconductor devices greatly reduces PC board floor space requirements as well as component installation costs.

By virtue of its inherently low intercontact capacitance and contact circuit losses, the 732 has proven to be excellent ultraminiature RF switch for frequency ranges well into the UHF spectrum. A typical RF application for the TO-5 relay is in handheld radio transceivers, wherein the combined features of good RF performance, small size, low coil power dissipation and high reliability make it a preferred method of Transmit-Receive switching.

- All welded construction
- Unique uni-frame design providing high magnetic efficiency and mechanical rigidity
- High force/mass ratio for resistance to shock and vibration
- Precious metal alloy contact material with gold plating assures excellent high current and dry circuit switching capabilities
- 10 Million Cycle Life

Relay Type		Part No.	Nominal Coil				Contact Load Rating	
DPDT Non-Latching Coil			Voltage (Vdc)	Resistance (Ω)	P.U.V (Vdc) (max.)	Base Current to Turn On (712 TN only)		
Diode Options			5	100	3.5	1.50	Resistive: 1A/28Vdc Inductive: 200mA/28Vdc (320mH) Lamp: 100mA/28Vdc Low Level: 10 to 50 uA/10 to 50 mV	
D = Internal diode for coil transient suppression			732	6	200	4.5		1.00
TN = Internal transistor driver and coil transient suppression diode			732D	9	400	6.8		0.75
Vibration	Shock		732TN	12	850	9.0		0.47
10 g's to 500 Hz	30 g's 6 msec, half-sine			18	1600	13.5		0.38
Temperature			26	3300	18.0	0.24		
Storage: -65°C to +125°C								
Operating: -55°C to +85°C								

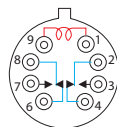

732

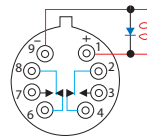

732D

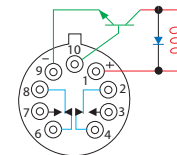

732TN

Schematics as viewed from terminals

COMMERCIAL SURFACE-MOUNT RELAYS

Series S114 & S134 Electromechanical Relays









The Series S114 Surface Mount Centigrad® Relay is an ultraminiature, hermetically sealed, armature relay. The low profile height .360" (9.14 mm) and .100" (2.54 mm) lead spacing make it ideal for applications where extreme packaging density and/or close PC board spacing are required. The specially formed leads are pre-tinned to make the relays ideal for most types of surface mount solder reflow processes.

The basic design and internal construction are identical to the Series 114 & 134 Centigrad® relays, and are capable of meeting Teledyne Relays' T2R® requirements.

The S114D and S114DD relays have internal discrete silicon diodes for coil suppression and polarity reversal protection.

The sensitive S134 surface mount Centigrad® Relay has a high resistance coil, thus requiring extremely low operating power (200 mW typical). The advantages of reduced heat dissipation and power supply demands are a plus.

- All welded construction
- Unique uni-frame design providing high magnetic efficiency and mechanical rigidity
- 10 Million Cycle Life
- High force/mass ratio for resistance to shock and vibration
- Precious metal alloy contact material with gold plating assures excellent high current and dry circuit switching capabilities

Relay Type	Part No.	Nominal Coil					Contact Load Rating
		Voltage (Vdc)	Resistance (Ω)	P.U.V (Vdc) (max.)	D.O.V (Vdc)		
Coil Type					min.	max.	
DPDT Non-Latching							
S114 = Standard Coil	 S114 S114D	5	50	3.5	0.14	2.3	Resistive: 1A/28Vdc Inductive: 200mA/28Vdc (320mH) Lamp: 100mA/28Vdc Low Level: 10 to 50 uA/10 to 50 mV
S134 = Sensitive Coil		6	98	4.5	0.18	3.2	
Diode Options		9	220	6.8	0.35	4.9	
		12	390	9.0	0.41	6.5	
		18	880	13.5	0.59	10.0	
D = Internal diode for coil transient suppression DD = Internal diode for coil transient suppression and polarity reversal protection	 S114DD	26	1560	18.0	0.89	13.0	
		5	39	4.0	0.6	2.8	Resistive: 1A/28Vdc Inductive: 200mA/28Vdc (320mH) Lamp: 100mA/28Vdc Low Level: 10 to 50 uA/10 to 50 mV
		6	78	5.0	0.7	3.4	
		9	220	7.8	0.8	5.3	
12	390	10.0	0.9	6.5			
Vibration	 S114DD	18	880	14.5	1.1	10.0	
		26	1560	19.0	1.4	13.0	
Shock	 S114DD	5	100	3.5	0.12	2.5	Resistive: 1A/28Vdc Inductive: 200mA/28Vdc (320mH) Lamp: 100mA/28Vdc Low Level: 10 to 50 uA/10 to 50 mV
		6	200	4.5	0.18	3.2	
Acceleration	 S134 S134D	9	400	6.8	0.35	4.9	
		12	800	9.0	0.41	6.5	
		18	1600	13.5	0.59	10.0	
Temperature	 S134DD	26	3200	18.0	0.89	13.0	Resistive: 1A/28Vdc Inductive: 200mA/28Vdc (320mH) Lamp: 100mA/28Vdc Low Level: 10 to 50 uA/10 to 50 mV
		5	64	3.7	0.7	2.6	
		6	125	4.8	0.8	3.0	
		9	400	8.0	0.9	4.5	
Storage: -65°C to +125°C	 S134DD	12	800	11.0	1.0	5.8	
		18	1600	14.5	1.1	9.0	
Operating: -55°C to +85°C	 S134DD	26	3200	19.0	1.3	13.0	

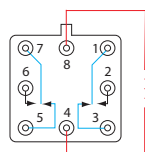

S114
S134

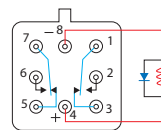

S114D
S134D

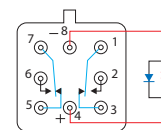

S114DD
S134DD

Schematics as viewed from terminals

COMMERCIAL SURFACE-MOUNT

COMMERCIAL SURFACE-MOUNT RELAYS

Series S172 Electromechanical Relays

The S172 surface mount Centigrad® relay is an ultraminiature, hermetically sealed, armature relay for commercial applications. Its low profile height .470" (11.94 mm) and .100" (2.54 mm) grid spaced terminals make it an ideal choice where extreme packaging density and/or close PC board spacing are required. The specially formed surface-mount leads are pre-tinned to make the relays ideal for all types of surface-mount solder reflow processes.

The basic design and internal structure are similar to Teledyne's DPDT 114 Centigrad® relay. (see page 16) The S172D relay has an internal discrete silicon diode for coil transient suppression.

- All welded construction
- Unique uni-frame design providing high magnetic efficiency and mechanical rigidity
- High force/mass ratio for resistance to shock and vibration
- Precious metal alloy contact material with gold plating assures excellent high current and dry circuit switching capabilities
- 5 Million Cycle Life

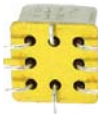
Relay Type		Part No.	Nominal Coil				Contact Load Rating
DPDT Non-Latching			Voltage (Vdc)	Resistance (Ω)	P.U.V (Vdc) (max.)	Operating Power (mW)	
Diode Options			5	64	3.8	405	Resistive: 1A/28Vdc Inductive: 200mA/28Vdc (320mH) Lamp: 100mA/28Vdc Low Level: 10 to 50 uA/10 to 50 mV
D = Internal diode for coil transient suppression			12	400	9.0	360	
Vibration			26	1600	18.0	440	
Shock							
10 g's to 500 Hz							
30 g's 6 msec, half-sine							
Temperature							
Storage: -65°C to +125°C							
Operating: -55°C to +85°C							

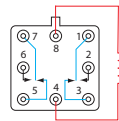

S172

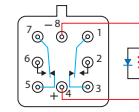

S172D

Series S422 Electromechanical Relays

The magnetic-latching TO-5 relay, originally conceived and developed by Teledyne, has become one of the industry standards for low-level switching from dry circuit to 1 ampere. Designed for high-density PC board surface mounting, its small size and low coil power dissipation make the S422 relay one of the most versatile ultraminiature relays available.

The Series S422D and S422DD utilize discrete diodes for coil suppression and polarity reversal protection. The Series S422 magnetic-latching relays are ideally suited for applications where power dissipation must be minimized. The relays can be operated with a short duration pulse. After the contacts have transferred, no external holding power is required. The magnetic-latching feature of the Series S422 relays provide a "memory" capability, since the relays will not reset upon removal of coil power.

- All welded construction
- Unique uni-frame design providing high magnetic efficiency and mechanical rigidity
- High force/mass ratio for resistance to shock and vibration
- Precious metal alloy contact material with gold plating assures excellent high current and dry circuit switching capabilities
- 10 Million Cycle Life

Relay Type		Part No.	Nominal Coil			Contact Load Rating
DPDT Magnetic-Latching			Voltage (Vdc)	Resistance (Ω)	Set & Reset Voltage (Vdc)	
Diode Options			5	61	3.5	Resistive: 1A/28Vdc Inductive: 200mA/28Vdc (320mH) Lamp: 100mA/28Vdc Low Level: 10 to 50 uA/10 to 50 mV
D = Internal diode for coil transient suppression			6	120	4.5	
DD = Internal diode for coil transient suppression and polarity reversal protection			9	280	6.8	
Vibration			12	500	9.0	
Shock			18	1130	13.5	
10 g's to 500 Hz		26	2000	18.0		
30 g's 6 msec, half-sine						
Temperature						
Storage: -65°C to +125°C						
Operating: -55°C to +85°C						

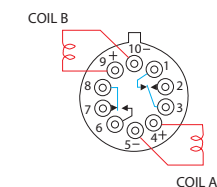

S422

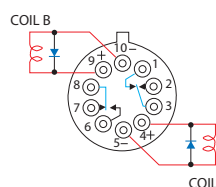

S422D

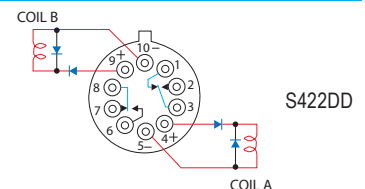

S422DD

Schematics as viewed from terminals

SCHEMATIC
(Coil A Last Energized)

SCHEMATIC
(Coil A Last Energized)

SCHEMATIC
(Coil A Last Energized)

ESTABLISHED RELIABILITY T²R RELAYS



Series ER114 Electromechanical Relays

The Series ER114 Centigrad® relay is an ultraminiature, hermetically sealed, armature relay. Its low profile height .275" (7 mm) and .100" (2.54 mm) grid spaced terminals, which precludes the need for spreader pads, make it ideal for applications where extreme packaging density and/or close PC board spacing are required. The basic design and internal construction are similar to the standard Teledyne DPDT TO-5 relay (e.g., Series ER412).

The Series ER114D and ER114DD relays have internal discrete silicon diodes for coil suppression and polarity reversal protection.

By virtue of its inherently low intercontact capacitance and contact circuit losses, the ER114 relay has proven to be an excellent ultraminiature RF switch for frequency ranges well into the UHF spectrum. A typical RF application for the ER114 relay is in handheld radio transceivers, wherein the combined features of good RF performance, small size, low coil power dissipation and high reliability make it a preferred method of Transmit-Receive switching.

- All welded construction
- Unique uni-frame design providing high magnetic efficiency and mechanical rigidity
- High force/mass ratio for resistance to shock and vibration
- Precious metal alloy contact material with gold plating assures excellent high current and dry circuit switching capabilities
- 10 Million Cycle Life

Relay Type	Part No.	Nominal Coil					Contact Load Rating	
		Voltage (Vdc)	Resistance (Ω)	P.U.V (Vdc) (max.)	D.O.V (Vdc)			
					min.	max.		
DPDT Non-Latching								
Diode Options								
D = Internal diode for coil transient suppression								
DD = Internal diode for coil transient suppression and polarity reversal protection								
Vibration	Shock							
30 g's to 3000 Hz	75 g's 6 msec, half-sine							
Acceleration	Temperature							
50 g's	Operating & Storage: -65°C to +125°C							
		ER114	5	50	3.5	0.14	2.3	Resistive: 1A/28Vdc
		ER114D	6	98	4.5	0.18	3.2	Inductive: 200mA/28Vdc (320mH)
			9	220	6.8	0.35	4.9	Lamp: 100mA/28Vdc
			12	390	9.0	0.41	6.5	Low Level: 10 to 50 uA/10 to 50 mV
			18	880	13.5	0.59	10.0	
			26	1560	18.0	0.89	13.0	
		ER114DD	5	39	4.0	0.6	2.8	Resistive: 1A/28Vdc
			6	78	5.0	0.7	3.4	Inductive: 200mA/28Vdc (320mH)
			9	220	7.8	0.8	5.3	Lamp: 100mA/28Vdc
			12	390	10.0	0.9	6.5	Low Level: 10 to 50 uA/10 to 50 mV
			18	880	14.5	1.1	10.0	
			26	1560	19.0	1.4	13.0	

Series ER116C Electromechanical Relays

The ER116C Centigrad® relay is an ultraminiature, hermetically sealed, armature relay capable of being directly driven by most IC logic families. Its low profile height and .100" (2.54 mm) grid spaced terminals, which preclude the need for spreader pads, make it ideal for applications where extreme packaging density and/or close PC board spacing are required.

The Series ER116C utilizes an internal silicon diode for coil suppression, a Zener diode to protect the MOSFET gate input, and an N-channel enhancement mode MOSFET chip, which enables direct relay interfacing with most Microprocessor and IC logic families (CMOS, TTL and MOS).

- All welded construction
- Unique uni-frame design providing high magnetic efficiency and mechanical rigidity
- High force/mass ratio for resistance to shock and vibration
- 10 Million Cycle Life

Relay Type	Part No.	Nominal Coil				Contact Load Rating		
		Voltage (Vdc)	Coil Current (mA)		Operating Power (mW)		P.U.V (Vdc) (max.)	
			Min.	Max.				
DPDT Non-Latching								
CMOS Feature								
Internal power MOSFET driver, Zener diode gate protection, and diode coil suppression								
Vibration	Shock							
30 g's to 3000 Hz	75 g's 6 msec, half-sine							
Acceleration	Temperature							
50 g's	Operating & Storage: -65°C to +125°C							
		ER116C	5	96.5	132.3	641	4.0	Resistive: 1A/28Vdc
			6	60.3	83.9	462	4.9	Inductive: 200mA/28Vdc (320mH)
			9	33.1	47.1	368	7.3	Lamp: 100mA/28Vdc
			12	24.9	36.1	369	9.8	Low Level: 10 to 50 uA/10 to 50 mV
			18	16.1	24.1	368	14.6	
			26	12.9	19.9	450	19.5	

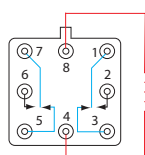

ER114

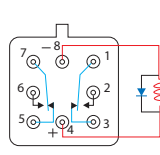

ER114D

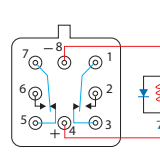

ER114DD

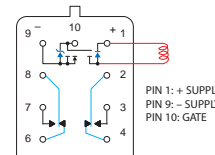

ER116C

PIN 1: + SUPPLY
PIN 9: - SUPPLY
PIN 10: GATE

P.U.V = Pick-Up Voltage



Schematics as viewed from terminals

ESTABLISHED RELIABILITY T²R RELAYS

Series ER134 Electromechanical Relays

The ER134 sensitive Centigrad® relay retains the same features as the ER114 standard Centigrad® relay with only a minimal increase in profile height .375" (9.53 mm). Its .100" (2.54 mm) grid spaced terminals, which preclude the need for spreader pads, and its low profile make the ER134 relay ideal for applications where high packaging density is important. The Series ER134D and ER134DD have internal discrete silicon diodes for coil suppression and polarity reversal protection. The sensitive ER134 Centigrad® relay has a high resistance coil, thus requiring extremely low operating power (200 mw typical). The advantages of reduced heat dissipation and power supply demands are a plus.

- All welded construction
- Unique uni-frame design providing high magnetic efficiency and mechanical rigidity
- High force/mass ratio for resistance to shock and vibration
- Precious metal alloy contact material with gold plating assures excellent high current and dry circuit switching capabilities
- 10 Million Cycle Life

Relay Type		Part No.	Nominal Coil				Contact Load Rating	
Diode Options			Voltage (Vdc)	Resistance (Ω)	P.U.V (Vdc) (max.)	D.O.V (Vdc)		
		min.				max.		
DPDT Non-Latching		 ER134 ER134D	5	100	3.5	0.12	2.5	Resistive: 1A/28Vdc Inductive: 200mA/28Vdc (320mH) Lamp: 100mA/28Vdc Low Level: 10 to 50 uA/10 to 50 mV
D = Internal diode for coil transient suppression			6	200	4.5	0.18	3.2	
DD = Internal diode for coil transient suppression and polarity reversal protection			9	400	6.8	0.35	4.9	
			12	800	9.0	0.41	6.5	
			18	1600	13.5	0.59	10.0	
Vibration		 ER134DD	5	64	3.7	0.7	2.6	Resistive: 1A/28Vdc Inductive: 200mA/28Vdc (320mH) Lamp: 100mA/28Vdc Low Level: 10 to 50 uA/10 to 50 mV
Shock			6	125	4.8	0.8	3.0	
30 g's to 3000 Hz			9	400	8.0	0.9	4.5	
75 g's 6 msec, half-sine			12	800	11.0	1.0	5.8	
Acceleration			18	1600	14.5	1.1	9.0	
Temperature		26	3200	19.0	1.3	13.0		
50 g's		Operating & Storage: -65°C to +125°C						

Series ER136C Electromechanical Relays

The sensitive ER136C Centigrad® relay is an ultraminiature, hermetically sealed, armature relay capable of being directly driven by most IC logic families. Its low profile height and .100" (2.54 mm) grid spaced terminals, which precludes the need for spreader pads, make it ideal for applications where extreme packaging density and/or close PC board spacing are required. The sensitive ER136C Centigrad® relay has a high resistance coil, thus requiring extremely low operating power (200 mW, typical). The advantages of reduced heat dissipation and power supply demands are a plus. The sensitive Series ER136C utilizes an internal silicon diode for coil suppression, a Zener diode to protect the MOSFET gate input, and an N-channel enhancement-mode MOSFET chip that enables direct relay interfacing with most microprocessor and IC logic families (CMOS, TTL and MOS).

- All welded construction
- Unique uni-frame design providing high magnetic efficiency and mechanical rigidity
- High force/mass ratio for resistance to shock and vibration
- 10 Million Cycle Life

Relay Type		Part No.	Nominal Coil				Contact Load Rating	
CMOS Feature			Voltage (Vdc)	Coil Current (mA)		Operating Power (mW)		P.U.V (Vdc) (max.)
		Min.		Max.				
DPDT Non-Latching		 ER136C	5	43.0	56.0	250	4.0	Resistive: 1A/28Vdc Inductive: 200mA/28Vdc (320mH) Lamp: 100mA/28Vdc Low Level: 10 to 50 uA/10 to 50 mV
Internal power MOSFET driver, Zener diode gate protection, and diode coil suppression			6	27.0	33.0	180	4.9	
Vibration			9	17.8	26.4	203	7.3	
Shock			12	11.3	17.7	180	9.8	
30 g's to 3000 Hz			18	8.4	13.8	203	14.6	
75 g's 6 msec, half-sine			26	5.8	10.2	219	19.5	
Acceleration		Operating & Storage: -65°C to +125°C						
Temperature		50 g's						

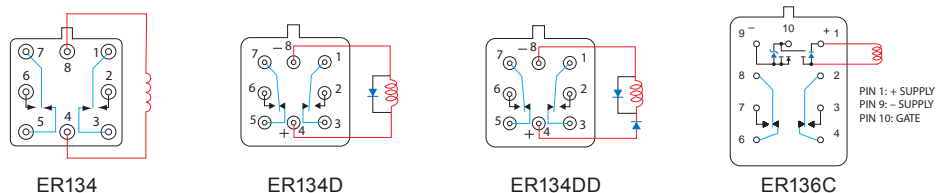

Schematics as viewed from terminals

P.U.V = Pick-Up Voltage
D.O.V = Drop-Out Voltage

ESTABLISHED RELIABILITY T²R RELAYS

Series ER411 & ER431 Electromechanical Relays







The TO-5 relay, originally conceived and developed by Teledyne, has become one of the industry standards for low-level switching from dry circuit to 1 ampere. Designed specifically for high-density PC board mounting, its small size and low coil power dissipation make the ER411 relay one of the most versatile ultraminiature relays available.

The Series ER411D and ER411DD relays have internal discrete silicon diodes for coil suppression and polarity reversal protection. The hybrid ER411T relay features an internal silicon suppression diode and transistor driver. This hybrid package reduces required PC board floor space by reducing the number of external components needed to drive the relay.

The sensitive ER431 relay has a high resistance coil, thus requiring extremely low operating power (150 mw typical). The advantages of reduced heat dissipation and power supply demands are a plus.

The Series ER431D and ER431DD relays have internal discrete silicon diodes for coil suppression and polarity reversal protection. The hybrid ER431T relay features an internal silicon suppression diode and transistor driver. This hybrid package reduces required PC board floor space by minimizing the number of external components needed to drive the relay.

- All welded construction
- Unique uni-frame design providing high magnetic efficiency and mechanical rigidity
- High force/mass ratio for resistance to shock and vibration
- Precious metal alloy contact material with gold plating assures excellent high current and dry circuit switching capabilities
- 10 Million Cycle Life

Relay Type		Part No.	Nominal Coil				Contact Load Rating	
SPDT Non-Latching			Voltage (Vdc)	Resistance (Ω)	P.U.V (Vdc) (max.)	D.O.V (Vdc)		
Coil Type						min.		max.
ER411 = Standard Coil		 ER411	5	63	3.7	0.15	2.4	Resistive: 1A/28Vdc Inductive: 200mA/28Vdc (320mH) Lamp: 100mA/28Vdc Low Level: 10 to 50 uA/10 to 50 mV
ER431 = Sensitive Coil			6	125	4.5	0.18	2.8	
Diode Options			9	280	6.8	0.35	4.2	
D = Internal diode for coil transient suppression			12	500	9.0	0.40	5.6	
DD = Internal diode for coil transient suppression and polarity reversal protection			18	1130	13.5	0.58	8.4	
T = Internal transistor drive and coil transient suppression diode		26	2000	18.0	0.89	10.4		
Vibration	Shock	 ER411DD	5	50	4.5	0.15	2.4	Resistive: 1A/28Vdc Inductive: 200mA/28Vdc (320mH) Lamp: 100mA/28Vdc Low Level: 10 to 50 uA/10 to 50 mV
30 g's to 3000 Hz	75 g's 6 msec, half-sine		6	98	5.5	0.18	2.8	
Acceleration	Temperature		9	280	7.8	0.35	4.2	
50 g's	Operating & Storage: -65°C to +125°C		12	500	10.0	0.40	5.6	
			18	1130	14.5	0.58	8.4	
		26	2000	19.0	0.89	10.4		
		 ER411T	5	63	3.9	0.15	2.4	Resistive: 1A/28Vdc Inductive: 200mA/28Vdc (320mH) Lamp: 100mA/28Vdc Low Level: 10 to 50 uA/10 to 50 mV
			6	125	5.2	0.18	2.8	
			9	280	7.8	0.35	4.2	
			12	500	10.0	0.40	5.6	
			18	1130	14.5	0.58	8.4	
		26	2000	19.0	0.89	10.4		
		 ER431	5	125	3.7	0.15	2.0	Resistive: 1A/28Vdc Inductive: 200mA/28Vdc (320mH) Lamp: 100mA/28Vdc Low Level: 10 to 50 uA/10 to 50 mV
			6	255	4.5	0.18	2.8	
			9	630	6.8	0.35	4.2	
			12	1025	9.0	0.41	5.6	
			18	2300	13.5	0.58	8.4	
		26	4000	18.0	0.89	10.4		
		 ER431DD	5	100	4.5	0.15	2.4	Resistive: 1A/28Vdc Inductive: 200mA/28Vdc (320mH) Lamp: 100mA/28Vdc Low Level: 10 to 50 uA/10 to 50 mV
			6	200	5.5	0.18	2.8	
			9	630	7.8	0.35	4.2	
			12	1025	10.0	0.40	5.6	
			18	2300	14.5	0.58	8.4	
		26	4000	19.0	0.89	10.4		
		 ER431T	5	125	3.6	0.15	2.0	Resistive: 1A/28Vdc Inductive: 200mA/28Vdc (320mH) Lamp: 100mA/28Vdc Low Level: 10 to 50 uA/10 to 50 mV
			6	255	4.8	0.18	2.8	
			9	630	7.8	0.35	4.2	
			12	1025	10.0	0.41	5.6	
			18	2300	14.5	0.58	8.4	
		26	4000	19.0	0.89	10.4		

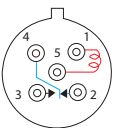

ER411
ER431

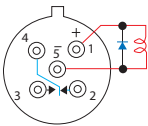

ER411D
ER431D

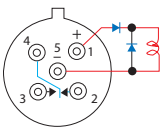

ER411DD
ER431DD

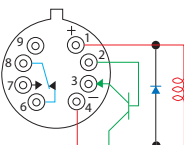

ER411T
ER431T

Schematics as viewed from terminals

P.U.V = Pick-Up Voltage
D.O.V = Drop-Out Voltage

ESTABLISHED RELIABILITY

ESTABLISHED RELIABILITY T²R RELAYS

Series ER412 & ER432 Electromechanical Relays





The TO-5 relay, originally conceived and developed by Teledyne, has become one of the industry standards for low-level switching from dry circuit to 1 ampere. Designed specifically for high-density PC board mounting, its small size and low coil power dissipation make the ER412 relay one of the most versatile ultraminiature relays available.

The Series ER412D and ER412DD relays have internal discrete silicon diodes for coil suppression and polarity reversal protection. The hybrid ER412T relay features an internal silicon suppression diode and transistor driver. This hybrid package reduces required PC board floor space by reducing the number of external components needed to drive the relay.

The sensitive ER432 relay has a high resistance coil, thus requiring extremely low operating power (200 mW typical). The advantages of reduced heat dissipation and power supply demands are a plus.

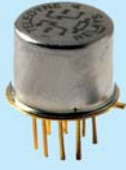
The Series ER432D and ER432DD relays have internal discrete silicon diodes for coil suppression and polarity reversal protection. The hybrid ER432T relay features an internal silicon suppression diode and transistor driver. This hybrid package reduces required PC board floor space by minimizing the number of external components needed to drive the relay.

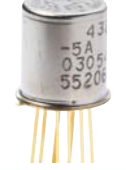
- All welded construction
- Unique uni-frame design providing high magnetic efficiency and mechanical rigidity
- High force/mass ratio for resistance to shock and vibration
- Precious metal alloy contact material with gold plating assures excellent high current and dry circuit switching capabilities
- 10 Million Cycle Life

Relay Type		Part No.	Nominal Coil				Contact Load Rating	
Coil Type			Voltage (Vdc)	Resistance (Ω)	P.U.V (Vdc) (max.)	D.O.V (Vdc)		
Diode Options								
DPDT Non-Latching								
ER412 = Standard Coil		 ER412	5	50	3.5	0.14	2.3	Resistive: 1A/28Vdc
ER432 = Sensitive Coil			6	98	4.5	0.18	3.2	Inductive: 200mA/28Vdc (320mH)
			9	220	6.8	0.35	4.9	Lamp: 100mA/28Vdc
			12	390	9.0	0.41	6.5	Low Level: 10 to 50 uA/10 to 50 uA
			18	880	13.5	0.59	10.0	
		26	1560	18.0	0.89	13.0		
D = Internal diode for coil transient suppression		 ER412DD	5	39	3.9	0.6	2.8	Resistive: 1A/28Vdc
DD = Internal diode for coil transient suppression and polarity reversal protection			6	78	5.2	0.7	3.4	Inductive: 200mA/28Vdc (320mH)
T = Internal transistor drive and coil transient suppression diode			9	220	7.8	0.8	5.3	Lamp: 100mA/28Vdc
			12	390	10.0	0.9	6.5	Low Level: 10 to 50 uA/10 to 50 uA
			18	880	14.5	1.1	10.0	
		26	1560	19.0	1.4	13.0		
Vibration		 ER412T	5	50	3.5	0.14	2.3	Resistive: 1A/28Vdc
Shock			6	98	4.5	0.18	3.2	Inductive: 200mA/28Vdc (320mH)
30 g's to 3000 Hz			9	220	6.8	0.35	4.9	Lamp: 100mA/28Vdc
75 g's 6 msec, half-sine			12	390	9.0	0.41	6.5	Low Level: 10 to 50 uA/10 to 50 mV
			18	880	13.5	0.59	10.0	
		26	1560	18.0	0.89	13.0		
Acceleration		 ER432	5	100	3.5	0.14	2.5	Resistive: 1A/28Vdc
Temperature			6	200	4.5	0.18	3.2	Inductive: 200mA/28Vdc (320mH)
50 g's			9	400	6.8	0.35	4.9	Lamp: 100mA/28Vdc
Operating & Storage: -65°C to +125°C			12	850	9.0	0.41	6.5	Low Level: 10 to 50 uA/10 to 50 mV
			18	1600	13.5	0.59	10.0	
		26	3300	18.0	0.89	13.0		
		 ER432DD	5	64	3.7	0.7	2.6	Resistive: 1A/28Vdc
			6	125	4.8	0.8	3.0	Inductive: 200mA/28Vdc (320mH)
			9	400	8.0	0.9	4.5	Lamp: 100mA/28Vdc
			12	850	11.0	1.0	5.8	Low Level: 10 to 50 uA/10 to 50 mV
			18	1600	14.5	1.1	9.0	
		26	3300	19.0	1.3	13.0		
		 ER432T	5	100	3.6	0.14	2.5	Resistive: 1A/28Vdc
			6	200	4.8	0.18	3.2	Inductive: 200mA/28Vdc (320mH)
			9	400	7.8	0.35	4.9	Lamp: 100mA/28Vdc
			12	850	11.0	0.41	6.5	Low Level: 10 to 50 uA/10 to 50 mV
			18	1600	14.5	0.59	10.0	
		26	3300	19.0	0.89	13.0		

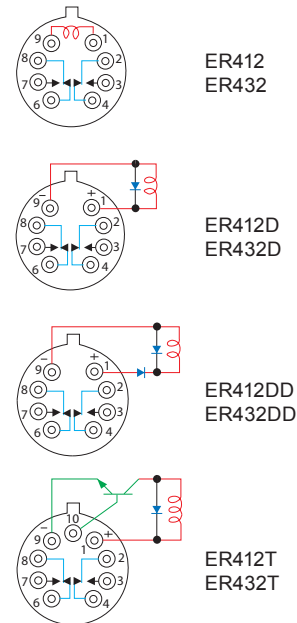

Schematics as viewed from terminals

P.U.V = Pick-Up Voltage
D.O.V = Drop-Out Voltage

ESTABLISHED RELIABILITY

ESTABLISHED RELIABILITY T²R RELAYS

Series 255, 257 Electromechanical Relays

The Series 255 is an industry-standard, half-size, latching crystal can relay. It has a wide range of switching capabilities ranging from low level to 2 amps. The Series J255/255 latching relay configuration is double-pole double-throw (DPDT), so the relay offers excellent switching density and versatility.

Half-Size Crystal Can Features:

- Low level to 2 amps
- Wide range of switching capabilities
- Smallest relay package capable of switching 2 amps
- Modernized assembly process
- Lead-free (gold-plated wire lead only)

- All welded construction
- Wire leads, gold-plated or solder-coated
- Matched seal for superior hermeticity
- Gold-plated contact assembly
- Modernized assembly process
- Advanced cleaning techniques
- 1 Million Cycle Life

Relay Type	Part No.	Nominal Coil				Contact Load Rating
		Voltage (Vdc)	Resistance (Ω)	Set & Reset Voltage		
				Min.	Max.	
DPDT Magnetic-Latching						
Vibration						
30G, 10-2500 Hz (Sinusoidal)		5	45	1.0	3.8	Resistive: 2A/28Vdc
Shock						
100G, 6 msec half-sine (Specified Pulse)		6	63	1.3	4.5	Inductive: 0.75A/28Vdc (320mH)
Temperature		12	254	2.6	9.0	Intermediate Current: 0.1A/28Vdc
Operating & Storage: -65°C to +125°C	258	26	1000	5.2	18.0	Lamp: 0.16A/28Vdc Low Level: 10 to 50 uA/10 to 50 mV

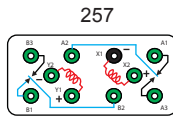

SCHEMATIC
(Coil X Last Energized)
(Bottom View)

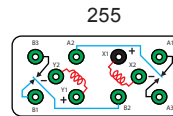

SCHEMATIC
(Coil X Last Energized)
(Bottom View)



Series ER421 Electromechanical Relays

The magnetic-latching TO-5 relay, originally conceived and developed by Teledyne, has become one of the industry standards for low-level switching from dry circuit to 1 ampere. Designed for high-density PC board mounting, its small size and low coil power dissipation make the ER421 relay one of the most versatile ultraminiature relays available.

The Series ER421D and ER421DD utilize discrete silicon diodes for coil suppression and polarity reversal protection.

The Series ER421 magnetic-latching relays are ideally suited for applications where coil power dissipation must be minimized. The relays can be operated with a short duration pulse. After the contacts have transferred, no external holding power is required. The magnetic-latching feature of the Series ER421 provides a "memory" capability, since the relays will not reset upon removal of coil power.

- All welded construction
- Unique uni-frame design providing high magnetic efficiency and mechanical rigidity
- High force/mass ratio for resistance to shock and vibration
- Precious metal alloy contact material with gold plating assures excellent high current and dry circuit switching capabilities
- 10 Million Cycle Life

Relay Type	Part No.	Nominal Coil			Contact Load Rating
		Voltage (Vdc)	Resistance (Ω)	Set & Reset Voltage (Vdc)	
SPDT Magnetic-Latching					
Diode Options					
D = Internal diode for coil transient suppression		5	61	3.5	Resistive: 1A/28Vdc
DD = Internal diode for coil transient suppression and polarity reversal protection		6	120	4.5	Inductive: 200mA/28Vdc (320mH)
Vibration		9	280	6.8	Lamp: 100mA/28Vdc
Shock		12	500	9.0	Low Level: 10 to 50 uA/10 to 50 mV
30 g's to 3000 Hz		18	1130	13.5	
Acceleration		5	61	3.7	Resistive: 1A/28Vdc
Temperature		6	120	4.5	Inductive: 200mA/28Vdc (320mH)
50 g's		9	280	6.8	Lamp: 100mA/28Vdc
Operating & Storage: -65°C to +125°C		12	500	9.0	Low Level: 10 to 50 uA/10 to 50 mV
		18	1130	13.5	
		5	48	4.5	Resistive: 1A/28Vdc
		6	97	5.5	Inductive: 200mA/28Vdc (320mH)
		9	280	7.8	Lamp: 100mA/28Vdc
		12	500	10.0	Low Level: 10 to 50 uA/10 to 50 mV
		18	1130	14.5	
		26	2000	19.0	

*See Schematics on Page 21

ESTABLISHED RELIABILITY

ESTABLISHED RELIABILITY T²R RELAYS



Series ER420 & ER422 Electromechanical Relays

The magnetic-latching TO-5 relay, originally conceived and developed by Teledyne, has become one of the industry standards for low-level switching from dry circuit to 1 ampere. Designed for high-density PC board mounting, its small size and low coil power dissipation make the ER420 & ER422 relays some of the most versatile ultraminiature relays available.

The Series ER420D/ER422D and ER420DD/ER422DD utilize discrete silicon diodes for coil suppression and polarity reversal protection.

The Series ER420/ER422 magnetic-latching relays are ideally suited for applications where coil power dissipation must be minimized. The relays can be operated with a short duration pulse. After the contacts have transferred, no external holding power is required. The magnetic-latching feature of the Series ER420/ER422 relays provide a "memory" capability, since the relays will not reset upon removal of coil power.

- All welded construction
- Unique uni-frame design providing high magnetic efficiency and mechanical rigidity
- High force/mass ratio for resistance to shock and vibration
- Precious metal alloy contact material with gold plating assures excellent high current and dry circuit switching capabilities
- 10 Million Cycle Life

Relay Type	Part No.	Nominal Coil			Contact Load Rating
		Voltage (Vdc)	Resistance (Ω)	Set & Reset Voltage (Vdc)	
DPDT Magnetic-Latching					
Grounding Options					
420 = Common					
422 = Individual					
Diode Options					
D = Internal diode for coil transient suppression					
DD = Internal diode for coil transient suppression and polarity reversal protection					
Vibration		Shock			
30 g's to 3000 Hz		100 g's 6 msec, half-sine			
Acceleration		Temperature			
50 g's		Operating & Storage: -65°C to +125°C			
					
	ER420	5	61	3.5	Resistive: 1A/28Vdc Inductive: 200mA/28Vdc (320mH) Lamp: 100mA/28Vdc Low Level: 10 to 50 uA/10 to 50 mV
	ER422	6	120	4.5	
	ER420D	9	280	6.8	
	ER422D	12	500	9.0	
	ER422D	18	1130	13.5	
					
	ER420DD	5	48	4.5	Resistive: 1A/28Vdc Inductive: 200mA/28Vdc (320mH) Lamp: 100mA/28Vdc Low Level: 10 to 50 uA/10 to 50 mV
	ER422DD	6	97	5.5	
	ER420DD	9	280	7.8	
	ER422DD	12	500	10.0	
	ER422DD	18	1130	14.5	
		26	2000	19.0	

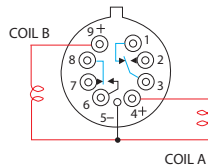

ER420

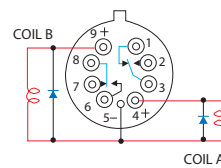

ER420D

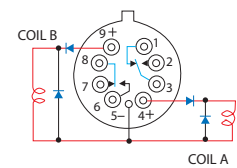

ER420DD

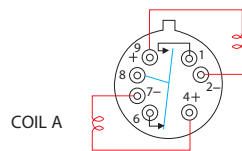

ER421

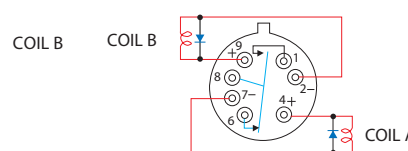

ER421D

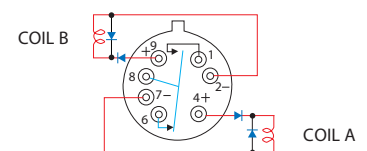

ER421DD

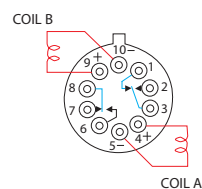

ER422

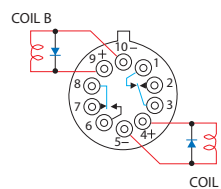

ER422D

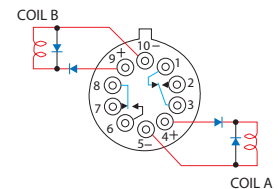

ER422DD

Schematics Shown with Coil A Last Energized
Schematics as viewed from terminals

MILITARY QUALIFIED (JAN) RELAYS



Series J114 Electromechanical Relays

The Series J114 Centigrad® relay is an ultraminiature, hermetically sealed, armature relay. Its low profile height .275" (7 mm) and .100" (2.54 mm) grid spaced terminals, which precludes the need for spreader pads, make it ideal for applications where extreme packaging density and/or close PC board spacing are required. The basic design and internal construction are similar to the standard Teledyne DPDT TO-5 relay (e.g., Series J412).

The Series J114D and J114DD relays have internal discrete silicon diodes for coil suppression and polarity reversal protection.

By virtue of its inherently low intercontact capacitance and contact circuit losses, the J114 relay has proven to be an excellent ultraminiature RF switch for frequency ranges well into the UHF spectrum. A typical RF application for the J114 relay is in handheld radio transceivers, wherein the combined features of good RF performance, small size, low coil power dissipation and high reliability make it a preferred method of Transmit-Receive switching.

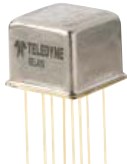
- All welded construction
- Unique uni-frame design providing high magnetic efficiency and mechanical rigidity
- High force/mass ratio for resistance to shock and vibration
- Precious metal alloy contact material with gold plating assures excellent high current and dry circuit switching capabilities
- 10 Million Cycle Life

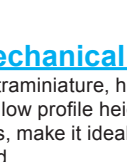
Relay Type		Part No.	Nominal Coil				Contact Load Rating	
DPDT Non-Latching			Voltage (Vdc)	Resistance (Ω)	P.U.V (Vdc) (max.)	D.O.V (Vdc)		
Diode Options						min.	max.	
D = Internal diode for coil transient suppression		 J114 (M39016/17)	5	50	3.5	0.14	2.3	Resistive: 1A/28Vdc Inductive: 200mA/28Vdc (320mH) Lamp: 100mA/28Vdc
DD = Internal diode for coil transient suppression and polarity reversal protection			6	98	4.5	0.18	3.2	
		 J114D (M39016/18)	9	220	6.8	0.35	4.9	Low Level: 10 to 50 uA/10 to 50 mV
Vibration			12	390	9.0	0.41	6.5	
Shock			18	880	13.5	0.59	10.0	
			26	1560	18.0	0.89	13.0	
		 J114DD (M39016/18)	5	39	4.0	0.6	2.8	Resistive: 1A/28Vdc Inductive: 200mA/28Vdc (320mH) Lamp: 100mA/28Vdc Low Level: 10 to 50 uA/10 to 50 mV
			6	78	5.0	0.7	3.4	
Acceleration			9	220	7.8	0.8	5.3	
Temperature			12	390	10.0	0.9	6.5	
			18	880	14.5	1.1	10.0	
			26	1560	19.0	1.4	13.0	

Series J116C Electromechanical Relays

The J116C Centigrad® relay is an ultraminiature, hermetically sealed, armature relay capable of being directly driven by most IC logic families. Its low profile height and .100" (2.54 mm) grid spaced terminals, which preclude the need for spreader pads, make it ideal for applications where extreme packaging density and/or close PC board spacing are required.

The Series J116C utilizes an internal silicon diode for coil suppression, a Zener diode to protect the MOSFET gate input, and an N-channel enhancement mode MOSFET chip, which enables direct relay interfacing with most Microprocessor and IC logic families (CMOS, TTL and MOS).

- All welded construction
- Unique uni-frame design providing high magnetic efficiency and mechanical rigidity
- High force/mass ratio for resistance to shock and vibration
- 10 Million Cycle Life

Relay Type		Part No.	Nominal Coil				Contact Load Rating	
DPDT Non-Latching			Voltage (Vdc)	Coil Current (mA)		Operating Power (mW)		P.U.V (Vdc) (max.)
CMOS Feature		Min.		Max.				
Internal power MOSFET driver, Zener diode gate protection, and diode coil suppression		 J116C (M28776/6)	5	96.5	132.3	641	4.0	Resistive: 1A/28Vdc Inductive: 200mA/28Vdc (320mH) Lamp: 100mA/28Vdc Low Level: 10 to 50 uA/10 to 50 mV
Vibration			6	60.3	83.9	462	4.9	
Shock			9	33.1	47.1	368	7.3	
			12	24.9	36.1	369	9.8	
			18	16.1	24.1	368	14.6	
			26	12.9	19.9	450	19.5	

Operating & Storage:	Temperature
50 g's	-65°C to +125°C

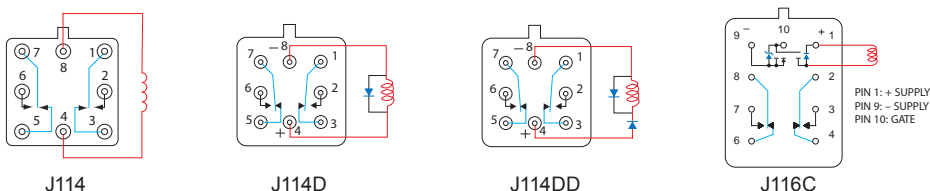

P.U.V = Pick-Up Voltage
D.O.V = Drop-Out Voltage

Schematics as viewed from terminals

MILITARY QUALIFIED (JAN) RELAYS



Series J134 Electromechanical Relays

The J134 sensitive Centigrad® relay retains the same features as the J114 standard Centigrad® relay with only a minimal increase in profile height .375" (9.53 mm). Its .100" (2.54 mm) grid spaced terminals, which preclude the need for spreader pads, and its low profile make the J134 relay ideal for applications where high packaging density is important.

The Series J134D and J134DD have internal discrete silicon diodes for coil suppression and polarity reversal protection.

The sensitive J134 Centigrad® relay has a high resistance coil, thus requiring extremely low operating power (200 mw typical). The advantages of reduced heat dissipation and power supply demands are a plus.

- All welded construction
- Unique uni-frame design providing high magnetic efficiency and mechanical rigidity
- High force/mass ratio for resistance to shock and vibration
- Precious metal alloy contact material with gold plating assures excellent high current and dry circuit switching capabilities
- 10 Million Cycle Life

Relay Type		Part No.	Nominal Coil				Contact Load Rating	
Diode Options			Voltage (Vdc)	Resistance (Ω)	P.U.V (Vdc) (max.)	D.O.V (Vdc)		
						min.	max.	
DPDT Non-Latching		 J134 (M39016/41)	5	100	3.5	0.12	2.5	Resistive: 1A/28Vdc Inductive: 200mA/28Vdc (320mH) Lamp: 100mA/28Vdc Low Level: 10 to 50 uA/10 to 50 mV
D = Internal diode for coil transient suppression			6	200	4.5	0.18	3.2	
DD = Internal diode for coil transient suppression and polarity reversal protection			9	400	6.8	0.35	4.9	
Vibration			12	800	9.0	0.41	6.5	
Shock			18	1600	13.5	0.59	10.0	
Temperature			26	3200	18.0	0.89	13.0	
30 g's to 3000 Hz		 J134DD (M39016/43)	5	64	3.7	0.7	2.6	Resistive: 1A/28Vdc Inductive: 200mA/28Vdc (320mH) Lamp: 100mA/28Vdc Low Level: 10 to 50 uA/10 to 50 mV
75 g's 6 msec, half-sine			6	125	4.8	0.8	3.0	
Acceleration			9	400	8.0	0.9	4.5	
Temperature			12	800	11.0	1.0	5.8	
Operating & Storage: -65°C to +125°C			18	1600	14.5	1.1	9.0	
50 g's			26	3200	19.0	1.3	13.0	

Series J136C Electromechanical Relays

The sensitive J136C Centigrad® relay is an ultraminiature, hermetically sealed, armature relay capable of being directly driven by most IC logic families. Its low profile height and .100" (2.54 mm) grid spaced terminals, which precludes the need for spreader pads, make it ideal for applications where extreme packaging density and/or close PC board spacing are required.

The sensitive J136C Centigrad® relay has a high resistance coil, thus requiring extremely low operating power (200 mW, typical). The advantages of reduced heat dissipation and power supply demands are a plus.

The sensitive Series J136C utilizes an internal silicon diode for coil suppression, a Zener diode to protect the MOSFET gate input, and an N-channel enhancement-mode MOSFET chip that enables direct relay interfacing with most microprocessor and IC logic families (CMOS, TTL and MOS).

- All welded construction
- Unique uni-frame design providing high magnetic efficiency and mechanical rigidity
- High force/mass ratio for resistance to shock and vibration
- Precious metal alloy contact material with gold plating assures excellent high current and dry circuit switching capabilities
- 10 Million Cycle Life

Relay Type		Part No.	Nominal Coil				Contact Load Rating	
CMOS Feature			Voltage (Vdc)	Coil Current (mA)		Operating Power (mW)		P.U.V (Vdc) (max.)
DPDT Non-Latching		 J136C (M28776/7)	5	43.0	56.0	250	4.0	Resistive: 1A/28Vdc Inductive: 200mA/28Vdc (320mH) Lamp: 100mA/28Vdc Low Level: 10 to 50 uA/10 to 50 mV
Internal power MOSFET driver, Zener diode gate protection, and diode coil suppression			6	27.0	33.0	180	4.9	
Vibration			9	17.8	26.4	203	7.3	
Shock			12	11.3	17.7	180	9.8	
Temperature			18	8.4	13.8	203	14.6	
Operating & Storage: -65°C to +125°C			26	5.8	10.2	219	19.5	

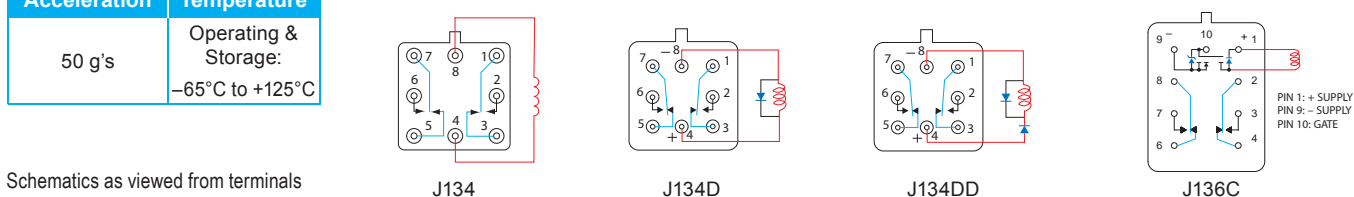

P.U.V = Pick-Up Voltage
D.O.V = Drop-Out Voltage

MILITARY QUALIFIED (JAN) RELAYS

Series J411 & J431 Electromechanical Relays









The TO-5 relay, originally conceived and developed by Teledyne, has become one of the industry standards for low-level switching from dry circuit to 1 ampere. Designed specifically for high-density PC board mounting, its small size and low coil power dissipation make the J411 relay one of the most versatile ultraminiature relays available.

The Series J411D and J411DD relays have internal discrete silicon diodes for coil suppression and polarity reversal protection. The hybrid J411T relay features an internal silicon suppression diode and transistor driver. This hybrid package reduces required PC board floor space by reducing the number of external components needed to drive the relay.

The sensitive J431 relay has a high resistance coil, thus requiring extremely low operating power (150 mw typical). The advantages of reduced heat dissipation and power supply demands are a plus.

The Series J431D and J431DD relays have internal discrete silicon diodes for coil suppression and polarity reversal protection. The hybrid J431T relay features an internal silicon suppression diode and transistor driver. This hybrid package reduces required PC board floor space by reducing the number of external components needed to drive the relay.

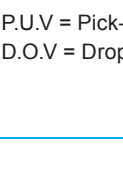
- All welded construction
- Unique uni-frame design providing high magnetic efficiency and mechanical rigidity
- High force/mass ratio for resistance to shock and vibration
- Precious metal alloy contact material with gold plating assures excellent high current and dry circuit switching capabilities
- 10 Million Cycle Life

Relay Type		Part No.	Nominal Coil				Contact Load Rating	
SPDT Non-Latching			Voltage (Vdc)	Resistance (Ω)	P.U.V (Vdc) (max.)	D.O.V (Vdc)		
Coil Type		min.				max.		
J411 = Standard Coil		 J411 (M39016/7)	5	63	3.7	0.15	2.4	Resistive: 1A/28Vdc Inductive: 200mA/28Vdc (320mH) Lamp: 100mA/28Vdc Low Level: 10 to 50 uA/10 to 50 mV
J431 = Sensitive Coil			6	125	4.5	0.18	2.8	
Diode Options			9	280	6.8	0.35	4.2	
D = Internal diode for coil transient suppression		 J411D (M39016/23)	12	500	9.0	0.40	5.6	Resistive: 1A/28Vdc Inductive: 200mA/28Vdc (320mH) Lamp: 100mA/28Vdc Low Level: 10 to 50 uA/10 to 50 mV
DD = Internal diode for coil transient suppression and polarity reversal protection			18	1130	13.5	0.58	8.4	
T = Internal transistor drive and coil transient suppression diode			26	2000	18.0	0.89	10.4	
Vibration			5	50	4.5	0.15	2.4	
Shock		 J411DD (M39016/24)	6	98	5.5	0.18	2.8	Resistive: 1A/28Vdc Inductive: 200mA/28Vdc (320mH) Lamp: 100mA/28Vdc Low Level: 10 to 50 uA/10 to 50 mV
30 g's to 3000 Hz			9	280	7.8	0.35	4.2	
75 g's 6 msec, half-sine			12	500	10.0	0.40	5.6	
Acceleration			18	1130	14.5	0.58	8.4	
Temperature		 J411T (M28776/5)	26	2000	19.0	0.89	10.4	Resistive: 1A/28Vdc Inductive: 200mA/28Vdc (320mH) Lamp: 100mA/28Vdc Low Level: 10 to 50 uA/10 to 50 mV
50 g's			5	63	3.9	0.15	2.4	
Operating & Storage: -65°C to +125°C			6	125	5.2	0.18	2.8	
			9	280	7.8	0.35	4.2	
		 J431 (M39016/10)	12	500	10.0	0.40	5.6	Resistive: 1A/28Vdc Inductive: 200mA/28Vdc (320mH) Lamp: 100mA/28Vdc Low Level: 10 to 50 uA/10 to 50 mV
			18	1130	14.5	0.58	8.4	
			26	4000	18.0	0.89	10.4	
			5	100	4.5	0.15	2.4	
		 J431DD (M39016/26)	6	255	4.5	0.18	2.8	Resistive: 1A/28Vdc Inductive: 200mA/28Vdc (320mH) Lamp: 100mA/28Vdc Low Level: 10 to 50 uA/10 to 50 mV
			9	630	6.8	0.35	4.2	
			12	1025	9.0	0.41	5.6	
			18	2300	13.5	0.58	8.4	
		 J431T (M28776/4)	26	4000	18.0	0.89	10.4	Resistive: 1A/28Vdc Inductive: 200mA/28Vdc (320mH) Lamp: 100mA/28Vdc Low Level: 10 to 50 uA/10 to 50 mV
			5	125	3.6	0.15	2.0	
			6	255	4.8	0.18	2.8	
			9	630	7.8	0.35	4.2	
		 J431T (M28776/4)	12	1025	10.0	0.41	5.6	Resistive: 1A/28Vdc Inductive: 200mA/28Vdc (320mH) Lamp: 100mA/28Vdc Low Level: 10 to 50 uA/10 to 50 mV
			18	2300	14.5	0.58	8.4	
			26	4000	19.0	0.89	10.4	

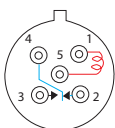

J411
J431

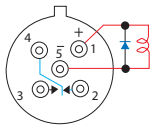

J411D
J431D

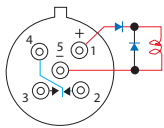

J411DD
J431DD

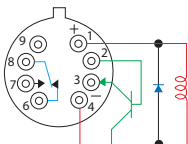

J411T
J431T

P.U.V = Pick-Up Voltage
D.O.V = Drop-Out Voltage

Schematics as viewed from terminals

MILITARY QUALIFIED (JAN)

MILITARY QUALIFIED (JAN) RELAYS

Series J412 & J432 Electromechanical Relays







The TO-5 relay, originally conceived and developed by Teledyne, has become one of the industry standards for low-level switching from dry circuit to 1 ampere. Designed specifically for high-density PC board mounting, its small size and low coil power dissipation make the J412 relay one of the most versatile ultraminiature relays available.

The Series J412D and J412DD relays have internal discrete silicon diodes for coil suppression and polarity reversal protection. The hybrid J412T relay features an internal silicon suppression diode and transistor driver. This hybrid package reduces required PC board floor space by reducing the number of external components needed to drive the relay.

The sensitive J432 relay has a high resistance coil, thus requiring extremely low operating power (200 mw typical). The advantages of reduced heat dissipation and power supply demands are a plus.

The Series J432D and J432DD relays have internal discrete silicon diodes for coil suppression and polarity reversal protection. The hybrid J432T relay features an internal silicon suppression diode and transistor driver. This hybrid package reduces required PC board floor space by reducing the number of external components needed to drive the relay.

- All welded construction
- Unique uni-frame design providing high magnetic efficiency and mechanical rigidity
- High force/mass ratio for resistance to shock and vibration
- Precious metal alloy contact material with gold plating assures excellent high current and dry circuit switching capabilities
- 10 Million Cycle Life

Relay Type		Part No.	Nominal Coil				Contact Load Rating	
Coil Type			Voltage (Vdc)	Resistance (Ω)	P.U.V (Vdc) (max.)	D.O.V (Vdc)		
Diode Options						min.	max.	
DPDT Non-Latching								
J412 = Standard Coil		 J412 (M39016/9)	5	50	3.5	0.14	2.3	Resistive: 1A/28Vdc
J432 = Sensitive Coil			6	98	4.5	0.18	3.2	Inductive: 200mA/28Vdc (320mH)
			9	220	6.8	0.35	4.9	Lamp: 100mA/28Vdc
			12	390	9.0	0.41	6.5	Low Level: 10 to 50 uA/10 to 50 uA
		 J412DD (M39016/20)	5	39	3.9	0.6	2.8	Resistive: 1A/28Vdc
			6	78	5.2	0.7	3.4	Inductive: 200mA/28Vdc (320mH)
			9	220	7.8	0.8	5.3	Lamp: 100mA/28Vdc
			12	390	10.0	0.9	6.5	Low Level: 10 to 50 uA/10 to 50 uA
		 J412T (M28776/1)	5	50	3.5	0.14	2.3	Resistive: 1A/28Vdc
			6	98	4.5	0.18	3.2	Inductive: 200mA/28Vdc (320mH)
			9	220	6.8	0.35	4.9	Lamp: 100mA/28Vdc
			12	390	9.0	0.41	6.5	Low Level: 10 to 50 uA/10 to 50 mV
		 J432 (M39016/11)	5	100	3.5	0.14	2.5	Resistive: 1A/28Vdc
			6	200	4.5	0.18	3.2	Inductive: 200mA/28Vdc (320mH)
			9	400	6.8	0.35	4.9	Lamp: 100mA/28Vdc
			12	850	9.0	0.41	6.5	Low Level: 10 to 50 uA/10 to 50 mV
		 J432DD (M39016/21)	5	64	3.7	0.7	2.6	Resistive: 1A/28Vdc
			6	125	4.8	0.8	3.0	Inductive: 200mA/28Vdc (320mH)
			9	400	8.0	0.9	4.5	Lamp: 100mA/28Vdc
			12	850	11.0	1.0	5.8	Low Level: 10 to 50 uA/10 to 50 mV
		 J432T (M28776/3)	5	100	3.6	0.14	2.5	Resistive: 1A/28Vdc
			6	200	4.8	0.18	3.2	Inductive: 200mA/28Vdc (320mH)
			9	400	7.8	0.35	4.9	Lamp: 100mA/28Vdc
			12	850	11.0	0.41	6.5	Low Level: 10 to 50 uA/10 to 50 mV
			18	1600	14.5	0.59	10.0	
			26	3300	19.0	0.89	13.0	

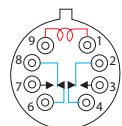

J412
J432

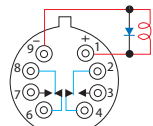

J412D
J432D

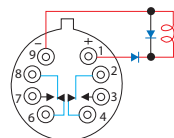

J412DD
J432DD

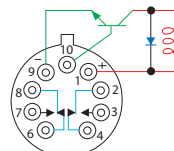

J412T
J432T

Schematics as viewed from terminals

P.U.V = Pick-Up Voltage
D.O.V = Drop-Out Voltage

MILITARY QUALIFIED (JAN)

MILITARY QUALIFIED (JAN) RELAYS

Series J255 Electromechanical Relays

The Series J255 is an industry-standard, half-size, latching crystal can relay. It has a wide range of switching capabilities ranging from low level to 2 amps. The Series J255 latching relay configuration is double-pole double-throw (DPDT), so the relay offers excellent switching density and versatility.

Half-Size Crystal Can Features:

- Low level to 2 amps
- Wide range of switching capabilities
- Smallest relay package capable of switching 2 amps
- Modernized assembly process
- Qualified to MIL-PRF39016/45
- Lead-free (gold-plated wire lead only)

- All welded construction
- Wire leads, gold-plated or solder-coated
- Matched seal for superior hermeticity
- Gold-plated contact assembly
- Modernized assembly process
- Advanced cleaning techniques
- 1 Million Cycle Life

Relay Type	Part No.	Nominal Coil			Contact Load Rating	
		Voltage (Vdc)	Resistance (Ω)	Set & Reset Voltage		
				Min.		Max.
DPDT Magnetic-Latching	 J255 (M39016/45)	5	45	1.0	3.8	Resistive: 2A/28Vdc
Vibration		6	63	1.3	4.5	Inductive: 0.75A/28Vdc (320mH)
30G, 10-2500 Hz (Sinusoidal)		12	254	2.6	9.0	Intermediate Current: 0.1A/28Vdc
Shock		26	1000	5.2	18.0	Lamp: 0.16A/28Vdc
100G, 6 msec half-sine (Specified Pulse)						Low Level: 10 to 50 uA/10 to 50 mV
Temperature						
Operating & Storage: -65°C to +125°C						

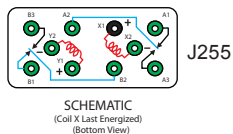



Series J421 Electromechanical Relays

The magnetic-latching TO-5 relay, originally conceived and developed by Teledyne, has become one of the industry standards for low-level switching from dry circuit to 1 ampere. Designed for high-density PC board mounting, its small size and low coil power dissipation make the J421 relay one of the most versatile ultraminiature relays available.

The Series J421D and J421DD utilize discrete silicon diodes for coil suppression and polarity reversal protection.

The Series J421 magnetic-latching relays are ideally suited for applications where coil power dissipation must be minimized. The relays can be operated with a short duration pulse. After the contacts have transferred, no external holding power is required. The magnetic-latching feature of the Series J421 provides a "memory" capability, since the relays will not reset upon removal of coil power.

- All welded construction
- Unique uni-frame design providing high magnetic efficiency and mechanical rigidity
- High force/mass ratio for resistance to shock and vibration
- Precious metal alloy contact material with gold plating assures excellent high current and dry circuit switching capabilities
- 10 Million Cycle Life

Relay Type	Part No.	Nominal Coil			Contact Load Rating
		Voltage (Vdc)	Resistance (Ω)	Set & Reset Voltage (Vdc)	
SPDT Magnetic-Latching	 J421 (M39016/8)	5	61	3.5	Resistive: 1A/28Vdc
Diode Options		6	120	4.5	Inductive: 200mA/28Vdc (320mH)
D = Internal diode for coil transient suppression		9	280	6.8	Lamp: 100mA/28Vdc
DD = Internal diode for coil transient suppression and polarity reversal protection		12	500	9.0	Low Level: 10 to 50 uA/10 to 50 mV
		18	1130	13.5	
Vibration	 J421D (M39016/27)	5	61	3.7	Resistive: 1A/28Vdc
Shock		6	120	4.5	Inductive: 200mA/28Vdc (320mH)
30 g's		9	280	6.8	Lamp: 100mA/28Vdc
100 g's 6 msec, half-sine		12	500	9.0	Low Level: 10 to 50 uA/10 to 50 mV
Acceleration		18	1130	13.5	
Temperature	 J421DD (M39016/28)	5	48	4.5	Resistive: 1A/28Vdc
Operating & Storage:		6	97	5.5	Inductive: 200mA/28Vdc (320mH)
-65°C to +125°C		9	280	7.8	Lamp: 100mA/28Vdc
		12	500	10.0	Low Level: 10 to 50 uA/10 to 50 mV
		18	1130	14.5	
	26	2000	19.0		

*See Schematics on Page 27

MILITARY QUALIFIED (JAN) RELAYS

Series J420 & J422 Electromechanical Relays

The magnetic-latching TO-5 relay, originally conceived and developed by Teledyne, has become one of the industry standards for low-level switching from dry circuit to 1 ampere. Designed for high-density PC board mounting, its small size and low coil power dissipation make the J420 & J422 relays some of the most versatile ultraminiature relays available.

The Series J420D/J422D and J420DD/J422DD utilize discrete silicon diodes for coil suppression and polarity reversal protection.

The Series J420/J422 magnetic-latching relays are ideally suited for applications where coil power dissipation must be minimized. The relays can be operated with a short duration pulse. After the contacts have transferred, no external holding power is required. The magnetic-latching feature of the Series J420/J422 relays provide a "memory" capability, since the relays will not reset upon removal of coil power.

- All welded construction
- Unique uni-frame design providing high magnetic efficiency and mechanical rigidity
- High force/mass ratio for resistance to shock and vibration
- Precious metal alloy contact material with gold plating assures excellent high current and dry circuit switching capabilities
- 10 Million Cycle Life

Relay Type		Part No.	Nominal Coil			Contact Load Rating
DPDT Magnetic-Latching			Voltage (Vdc)	Resistance (Ω)	Set & Reset Voltage (Vdc)	
Grounding Options						
J420 = Common						
J422 = Individual						
Diode Options						
D = Internal diode for coil transient suppression						
DD = Internal diode for coil transient suppression and polarity reversal protection						
Vibration	Shock					
30 g's to 3000 Hz	100 g's 6 msec, half-sine					
Acceleration	Temperature					
50 g's	Operating & Storage: -65°C to +125°C					

Part No.	Voltage (Vdc)	Resistance (Ω)	Set & Reset Voltage (Vdc)	Contact Load Rating
J420 (M39016/12)	5	61	3.5	Resistive: 1A/28Vdc
J422 (M39016/12)	6	120	4.5	Inductive: 200mA/28Vdc (320mH)
J420D (M39016/29)	9	280	6.8	Lamp: 100mA/28Vdc
J422D (M39016/29)	12	500	9.0	Low Level: 10 to 50 uA/10 to 50 mV
J420DD (M39016/30)	18	1130	13.5	
J422DD (M39016/30)	26	2000	18.0	

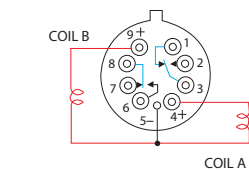

J420

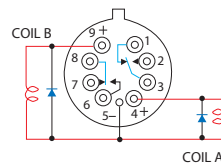

J420D

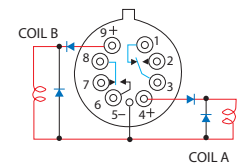

J420DD

Schematics Shown with Coil A Last Energized
Schematics as viewed from terminals

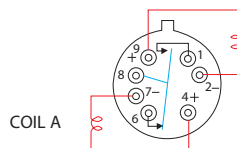

J421

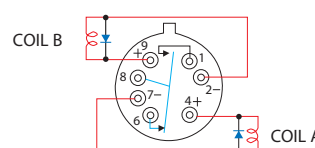

J421D

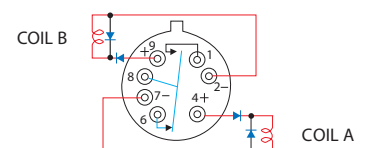

J421DD

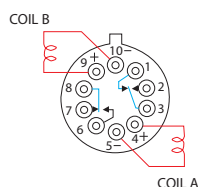

J422

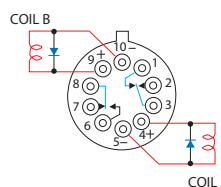

J422D

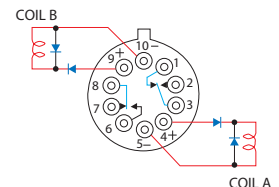

J422DD

HIGH-PERFORMANCE RELAYS

Series 412H, 422H & 432H Electromechanical Relays - High Temperature

The TO-5 relay, originally conceived and developed by Teledyne, has become one of the industry standards for low-level switching from dry circuit to 1 ampere. Designed for high-density PC board mounting, these TO-5 relays are some of the most versatile ultraminiature relays available because of their small size and low coil power dissipation.



The H Series high-temperature TO-5 relays are designed for reliable operation in elevated ambient temperatures up to 200°C. Special material selection and processing provide assurance of freedom from contact contamination and mechanical malfunctioning that might otherwise be caused by ultra high ambient temperature conditions.

Typical applications:

- Oil exploration (down-hole) instrumentation
- High-Temperature industrial and process control instrumentation

- All welded construction
- Unique uni-frame design providing high magnetic efficiency and mechanical rigidity
- High force/mass ratio for resistance to shock and vibration
- Precious metal alloy contact material with gold plating assures excellent high current and dry circuit switching capabilities
- 10 Million Cycle Life

Relay Type
412H = DPDT Non-Latching 432H = DPDT Non-Latching 422H = DPDT Magnetic-Latching
Coil Type
412H = Standard Coil 422H = Standard Coil 432H = Sensitive Coil
Vibration
30 g's to 3000 Hz
Shock
412H = 75 g's 6 msec, half-sine 432H = 75 g's 6 msec, half-sine 422H = 100 g's
Acceleration
50 g's
Temperature
Operating & Storage: -65°C to +200°C

Part No.	Nominal Coil					Contact Load Rating
	Voltage (Vdc)	Resistance (Ω)	P.U.V (Vdc) (max.)	D.O.V (Vdc)		
				min.	max.	
 412H	5	50	4.7	0.14	2.4	Resistive: 1A/28Vdc Inductive: 200mA/28Vdc (320mH) Lamp: 100mA/28Vdc Low Level: 10 to 50 uA/10 to 50 mV
	6	98	5.9	0.18	3.4	
	9	220	9.0	0.35	5.1	
	12	390	11.9	0.41	6.8	
	18	880	17.8	0.59	10.2	
 432H	5	100	4.7	0.14	2.4	Resistive: 1A/28Vdc Inductive: 200mA/28Vdc (320mH) Lamp: 100mA/28Vdc Low Level: 10 to 50 uA/10 to 50 mV
	6	200	5.9	0.18	3.4	
	9	400	9.0	0.35	5.1	
	12	850	11.9	0.41	6.8	
	18	1600	17.8	0.59	10.2	
26	3300	24.0	0.89	13.5		

Part No.	Nominal Coil			Contact Load Rating
	Voltage (Vdc)	Resistance (Ω)	Set & Reset Voltage (Vdc)	
 422H	5	61	4.7	Resistive: 1A/28Vdc Inductive: 200mA/28Vdc (320mH) Lamp: 100mA/28Vdc Low Level: 10 to 50 uA/10 to 50 mV
	6	120	5.9	
	9	280	9.0	
	12	500	11.9	
	18	1130	17.8	
26	2000	24.0		

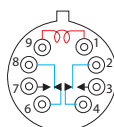

412H
432H

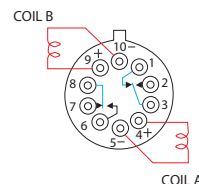

SCHEMATIC
(Coil A Last Energized)
422H

Schematics as viewed from terminals

P.U.V = Pick-Up Voltage

D.O.V = Drop-Out Voltage

HIGH-PERFORMANCE RELAYS

Series 412K & 422K Electromechanical Relays - High Shock

The TO-5 relay, originally conceived and developed by Teledyne, has become one of the industry standards for low-level switching from dry circuit to 1 ampere. Designed for high-density PC board mounting, its small size and low coil power dissipation make the TO-5 relay one of the most versatile subminiature relays available.

The K Series high-shock TO-5 relays are designed to withstand shock levels up to 4000 g's, .5 msec duration. Special material selection and construction details provide assurance that critical elements of the relay structure and mechanism will not be permanently displaced or damaged as a result of extremely high g level shocks.

Typical applications:

- Commercial avionics aircraft control
- Commercial aircraft control systems
- Transportation systems (rail/truck)

- All welded construction
- Unique uni-frame design providing high magnetic efficiency and mechanical rigidity
- High force/mass ratio for resistance to shock and vibration
- Precious metal alloy contact material with gold plating assures excellent high current and dry circuit switching capabilities
- 10 Million Cycle Life

Relay Type	Part No.	Nominal Coil					Contact Load Rating
		Voltage (Vdc)	Resistance (Ω)	P.U.V (Vdc) (max.)	D.O.V (Vdc)		
					min.	max.	
412K = DPDT Non-Latching	 412K	5	50	4.3	0.14	2.5	Resistive: 1A/28Vdc Inductive: 200mA/28Vdc (320mH) Lamp: 100mA/28Vdc Low Level: 10 to 50 uA/10 to 50 mV
422K = DPDT Magnetic-Latching		6	80	5.2	0.18	3.2	
Vibration		9	160	7.6	0.35	4.9	
30 g's to 3000 Hz		12	300	10.0	0.41	6.5	
Shock		18	600	14.3	0.59	10.0	
412K = 75 g's 6 msec, half-sine		26	1350	21.0	0.89	13.0	

Relay Type	Part No.	Nominal Coil			Contact Load Rating
		Voltage (Vdc)	Resistance (Ω)	Set & Reset Voltage (Vdc)	
2100 g's, 0.5 msec axial plane, half-sine	6	120	4.5		
1000 g's, 0.5 msec side planes, half-sine	9	280	6.8		
422K = 100 g's 6 msec, half-sine	12	500	9.0		
2100 g's, 0.5 msec axial plane, half-sine	18	1130	13.5		
750 g's, 0.5 msec side planes, half-sine	26	2000	18.0		

Acceleration
50 g's
Temperature
Operating & Storage: -65°C to +125°C

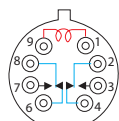

412K

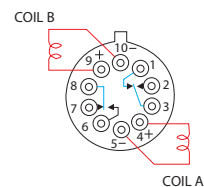

SCHEMATIC
(Coil A Last Energized)

422K

Schematics as viewed from terminals

P.U.V = Pick-Up Voltage

D.O.V = Drop-Out Voltage

HIGH-PERFORMANCE RELAYS

Series 412V & 432V Electromechanical Relays - High Vibration



The 412V and 432V TO-5 relays, originally conceived and developed by Teledyne, have become the industry standards for low level switching from dry circuit to 1 ampere in high-vibration environments. Designed for high-density PC board mounting, these TO-5 relays are some of the most versatile ultraminiature relay available because of their small size and low coil power dissipation.

The V Series high-vibration relays are designed to withstand vibration levels of 250 to 380 g's at the frequencies noted, when tested on a resonant beam for 10 to 20 seconds, in the axis parallel to contact motion (x-axis), or 100 g's 10-2000 Hz for 20 minutes in the x-axis. A unique magnetic circuit prevents contact opening (chatter) in excess of 10 microseconds under vibration or shock conditions.

Typical applications:

- Avionics aircraft control
- Aircraft control systems
- Transportation systems (rail/truck)

- All welded construction
- Unique uni-frame design providing high magnetic efficiency and mechanical rigidity
- High force/mass ratio for resistance to shock and vibration
- Precious metal alloy contact material with gold plating assures excellent high current and dry circuit switching capabilities
- 10 Million Cycle Life

Relay Type	Part No.	Nominal Coil					Contact Load Rating		
		Voltage (Vdc)	Resistance (Ω)	P.U.V (Vdc) (max.)	D.O.V (Vdc)				
Coil Type					min.	max.			
DPDT Non-Latching									
Coil Type									
412V = Standard Coil			412V 412DV	5	50	4.6	0.14	2.3	Resistive: 1A/28Vdc Inductive: 200mA/28Vdc (320mH) Lamp: 100mA/28Vdc Low Level: 10 to 50 uA/10 to 50 mV
432V = Sensitive Coil				6	70	5.5	0.18	3.2	
Diode Options				9	155	8.2	0.35	4.9	
D = Internal diode for coil transient suppression				12	235	11.0	0.41	6.5	
DD = Internal diode for coil transient suppression and polarity reversal protection				18	610	16.5	0.59	10.0	
Vibration		26	1130	22.0	0.89	13.0			
250 g's at 140 ±5 Hz			412DDV	5	33	4.6	0.6	2.8	Resistive: 1A/28Vdc Inductive: 200mA/28Vdc (320mH) Lamp: 100mA/28Vdc Low Level: 10 to 50 uA/10 to 50 mV
350 g's at 170 ±5 Hz				6	44	5.5	0.7	3.4	
380 g's at 200 ±5 Hz				9	125	8.2	0.8	5.3	
Shock				12	215	11.0	0.9	6.5	
150 g's 11 msec, half-sine				18	470	16.5	1.1	10.0	
Acceleration		26	1050	22.0	1.4	13.0			
50 g's			432V 432DV	5	80	4.6	0.14	2.5	Resistive: 1A/28Vdc Inductive: 200mA/28Vdc (320mH) Lamp: 100mA/28Vdc Low Level: 10 to 50 uA/10 to 50 mV
Temperature				6	120	5.5	0.18	3.2	
Operating & Storage:				9	240	8.2	0.35	4.9	
-65°C to +125°C				12	480	11.0	0.41	6.5	
				18	950	16.5	0.59	10.0	
		26	1900	22.0	0.89	13.0			

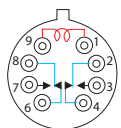

412V
432V

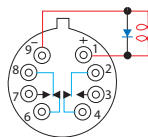

412DV
432DV

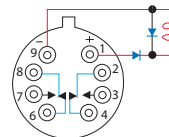

412DDV

Schematics as viewed from terminals

P.U.V = Pick-Up Voltage

D.O.V = Drop-Out Voltage

APPENDIX: SIGNAL INTEGRITY EYE DIAGRAMS

SERIES SI800 / SI803

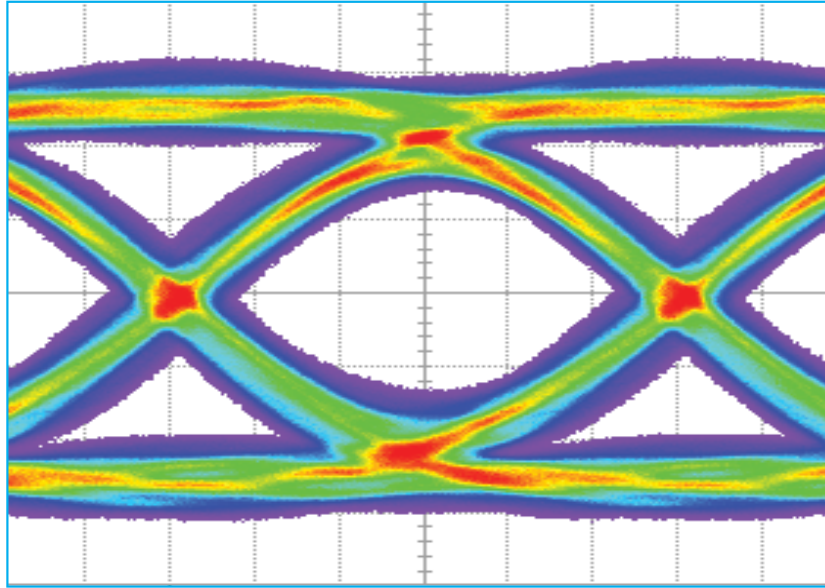

Bit Rate	Eye Height	Eye Width	Jitter _{p,p}
20 Gbps	191 mV	37 ps	10.22 ps

SERIES RF121

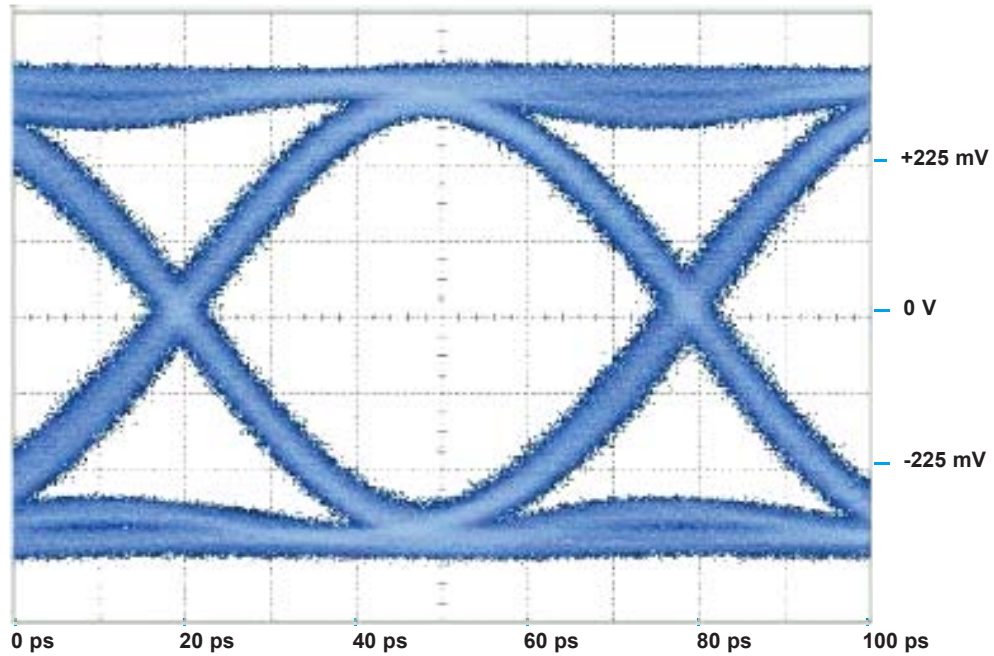

Bit Rate	Eye Height	Eye Width	Jitter _{p,p}
20 Gbps	360 mV	40.3 ps	6.93 ps

APPENDIX: SIGNAL INTEGRITY EYE DIAGRAMS

GRF121 @ 16Gbps

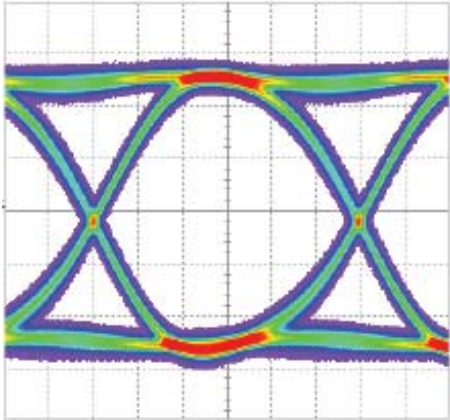

Bit Rate	Eye Height	Eye Width	Jitter _{p,p}
16 Gbps	203 mV	49.92 ps	4.99 ps

Reference @ 16Gbps

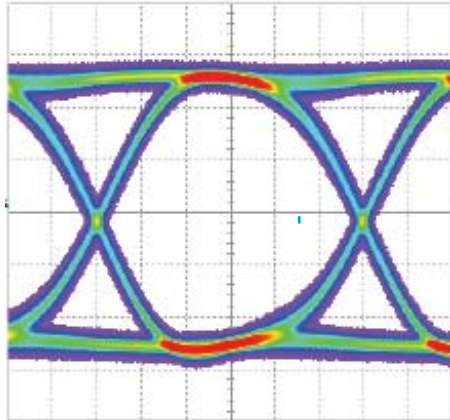

GRF121 @ 28Gbps

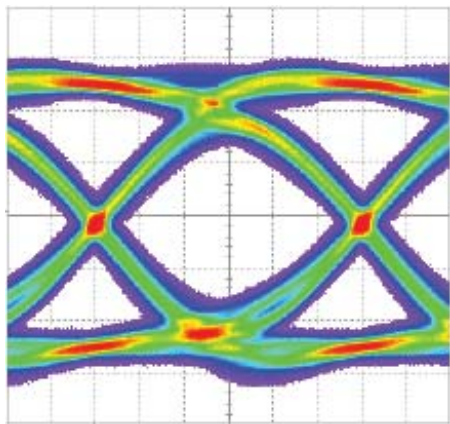

Bit Rate	Eye Height	Eye Width	Jitter _{p,p}
28 Gbps	139.2 mV	21.6 ps	5.89 ps

Reference @ 28Gbps

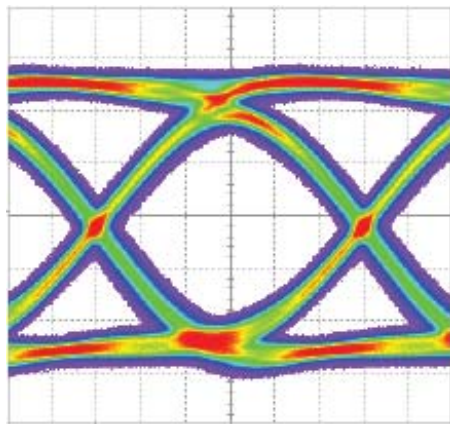

GRF121 @ 40Gbps

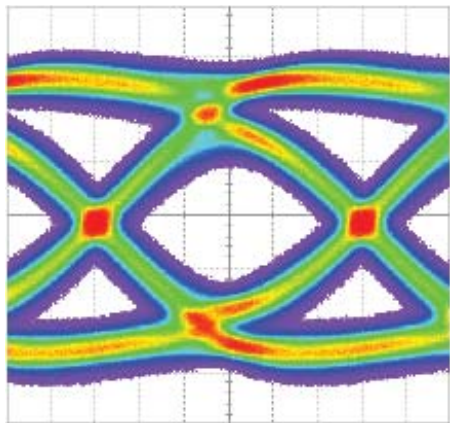

Bit Rate	Eye Height	Eye Width	Jitter _{p,p}
40 Gbps	95 mV	13.34 ps	8.73 ps

Reference @ 40Gbps

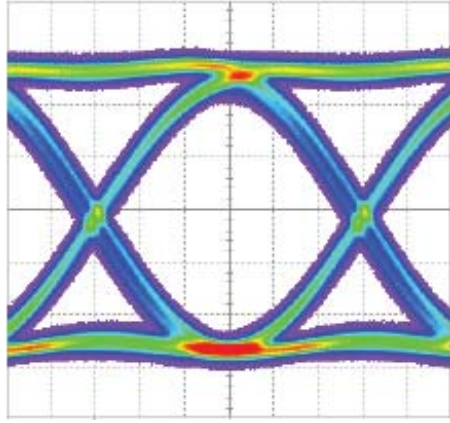

APPENDIX: SIGNAL INTEGRITY EYE DIAGRAMS

SERIES LB363

AC BYPASS (Capacitor Path) @ 16 Gbps

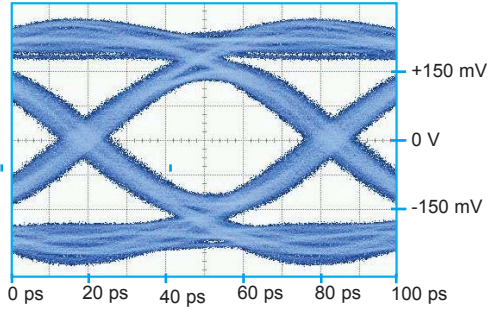

Bit Rate	Eye Height	Eye Width	Jitter _{r,p,p}
16 Gbps	170 mV	46.0 ps	16.44 ps

Normally Closed Path @ 16 Gbps

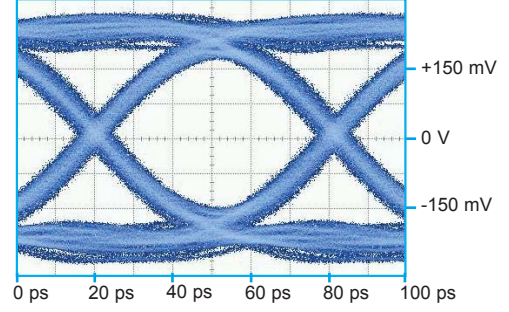

Bit Rate	Eye Height	Eye Width	Jitter _{r,p,p}
16 Gbps	262 mV	49.8 ps	11.33 ps

SERIES GLB363

AC BYPASS (Capacitor Path) @ 16 Gbps

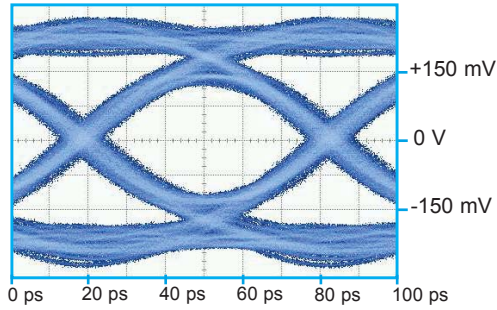

Bit Rate	Eye Height	Eye Width	Jitter _{r,p,p}
16 Gbps	157 mV	49.4 ps	14.22 ps

Normally Closed Path @ 16 Gbps

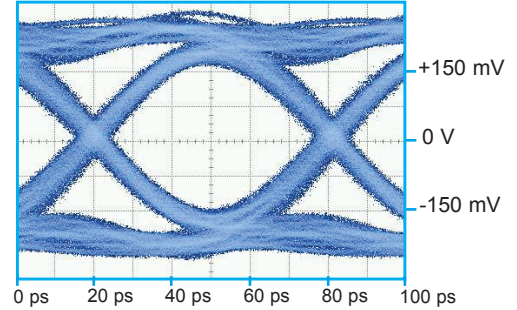

Bit Rate	Eye Height	Eye Width	Jitter _{r,p,p}
16 Gbps	251 mV	49.2 ps	10.67 ps

SERIES SGLB363

AC BYPASS (Capacitor Path) @ 16 Gbps

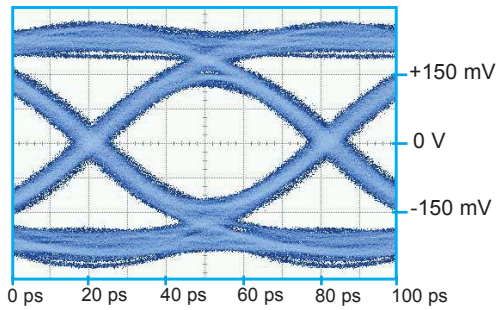

Bit Rate	Eye Height	Eye Width	Jitter _{r,p,p}
16 Gbps	173 mV	48.3 ps	12.67 ps

Normally Closed Path @ 16 Gbps

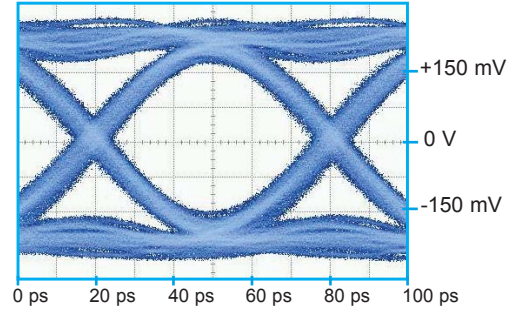

Bit Rate	Eye Height	Eye Width	Jitter _{r,p,p}
16 Gbps	288 mV	47.9 ps	11.56 ps

APPENDIX: SIGNAL INTEGRITY EYE DIAGRAMS

SERIES RF300/RF303

Normally Closed

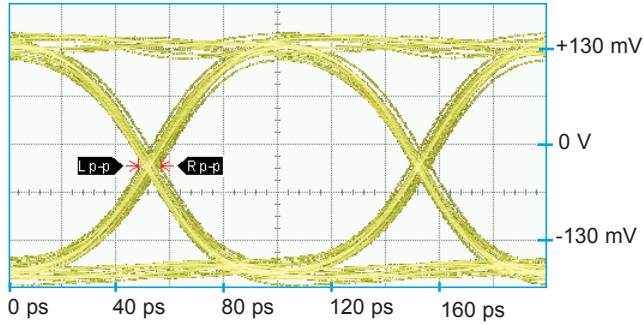

Eye Height	Eye Width	SNR	Jitter _{p-p}
254.7 mV	90.38 ps	18.52	8.44 ps

Normally Open

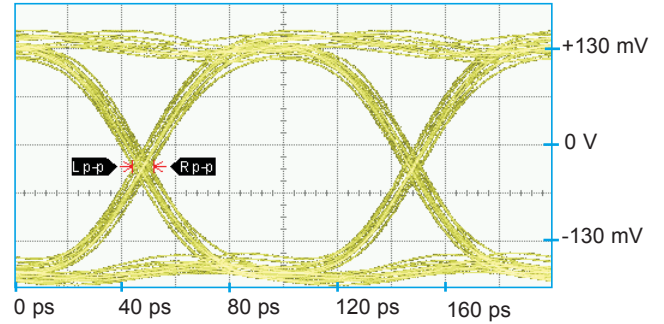

Eye Height	Eye Width	SNR	Jitter _{p-p}
250.9 mV	88.21 ps	16.84	8.00 ps

SERIES SRF300/SRF303

Normally Closed

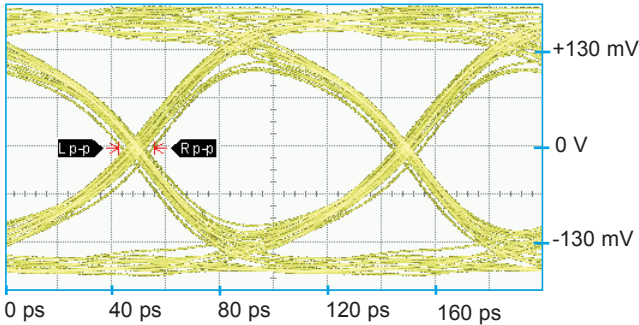

Eye Height	Eye Width	SNR	Jitter _{p-p}
137.9 mV	85.83 ps	6.31	13.33 ps

Normally Open

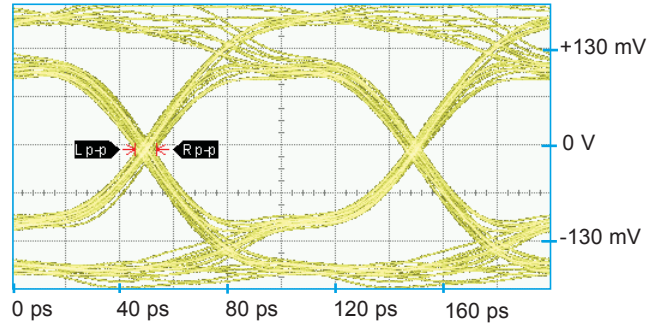

Eye Height	Eye Width	SNR	Jitter _{p-p}
72.8 mV	88.1 ps	4.31	8.00 ps

SERIES GRF300/GRF303

Normally Closed

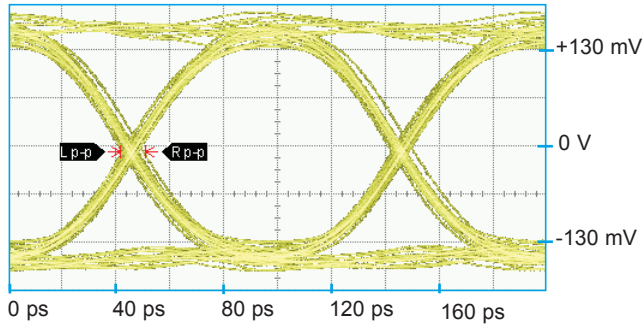

Eye Height	Eye Width	SNR	Jitter _{p-p}
237.6 mV	90.08 ps	14.19	9.33 ps

Normally Open

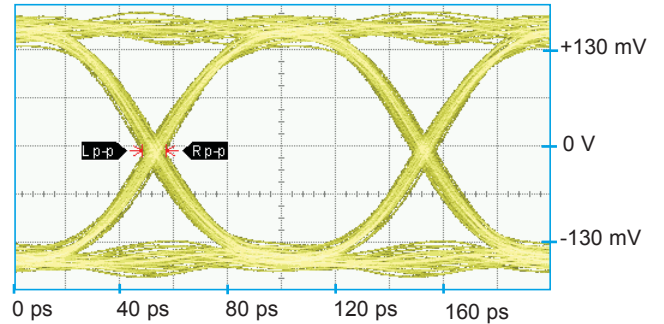

Eye Height	Eye Width	SNR	Jitter _{p-p}
255.2 mV	88.93 ps	17.74	8.89 ps

APPENDIX: SIGNAL INTEGRITY EYE DIAGRAMS

SERIES SGRF300/SGRF303

Normally Closed

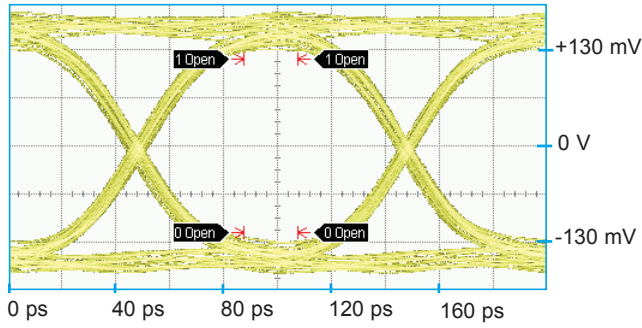

Eye Height	Eye Width	SNR	Jitter _{P-P}
233.3 mV	89.08 ps	13.18	7.56 ps

Normally Open

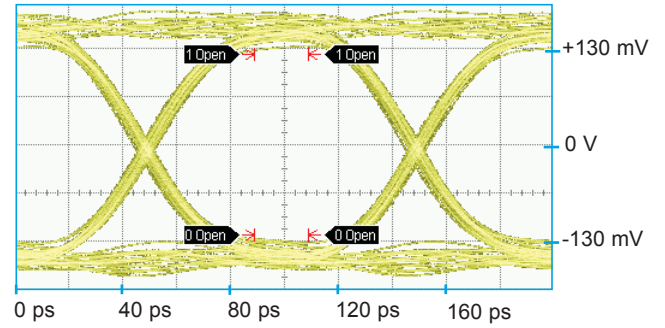

Eye Height	Eye Width	SNR	Jitter _{P-P}
243.1 mV	90.29 ps	15.21	7.56 ps

PATTERN GENERATOR SETTINGS
 10 Gbps Random Pulse Pattern Generator
 2³¹ - 1 PRBS signal
 PRBS output of 300mV_{P-P} (nominal)
 RF PCB effect (negligible) not removed from measurement
 Data shown is typical of both poles

APPENDIX: SIGNAL INTEGRITY EYE DIAGRAMS

SERIES RF100

Normally Closed

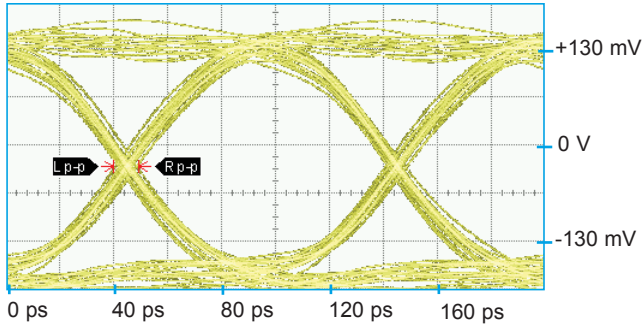

Eye Height	Eye Width	SNR	Jitter _{p-p}
233.7 mV	88.88 ps	13.01	9.33 ps

Normally Open

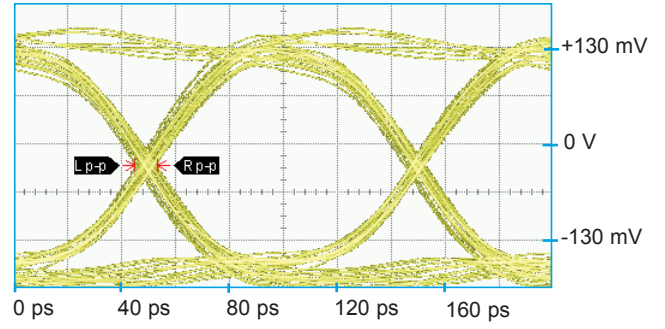

Eye Height	Eye Width	SNR	Jitter _{p-p}
217.1 mV	88.05 ps	11.55	8.44 ps

SERIES GRF100

Normally Closed

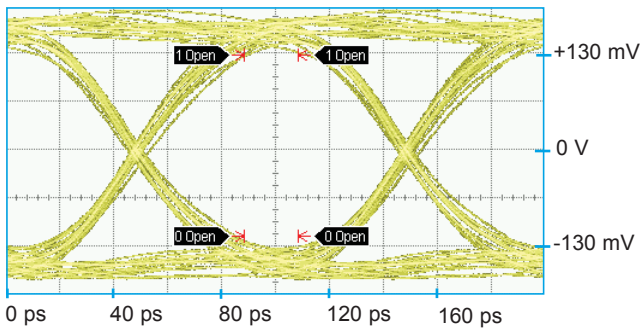

Eye Height	Eye Width	SNR	Jitter _{p-p}
242.5 mV	90.09 ps	14.20	8.44 ps

Normally Open

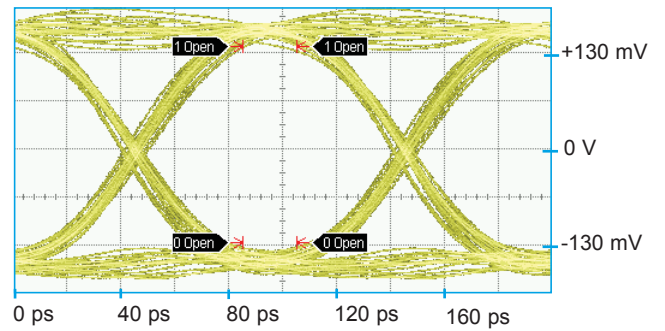

Eye Height	Eye Width	SNR	Jitter _{p-p}
263.6 mV	87.29 ps	20.23	9.78 ps

APPENDIX: SIGNAL INTEGRITY EYE DIAGRAMS

SERIES SGRF100

Normally Closed

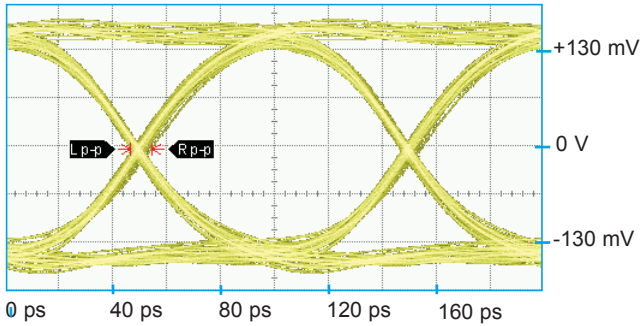

Eye Height	Eye Width	SNR	Jitter _{p-p}
251.5 mV	92.04 ps	15.11	8.00 ps

Normally Open

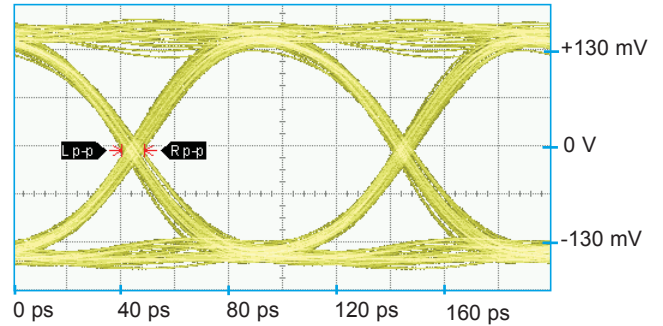

Eye Height	Eye Width	SNR	Jitter _{p-p}
261.2 mV	87.64 ps	18.20	8.44 ps

SERIES GRF172

Normally Closed

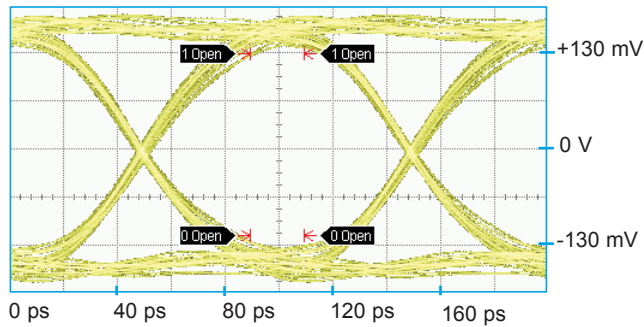

Eye Height	Eye Width	SNR	Jitter _{p-p}
246.1 mV	92.45 ps	14.59	6.22 ps

Normally Open

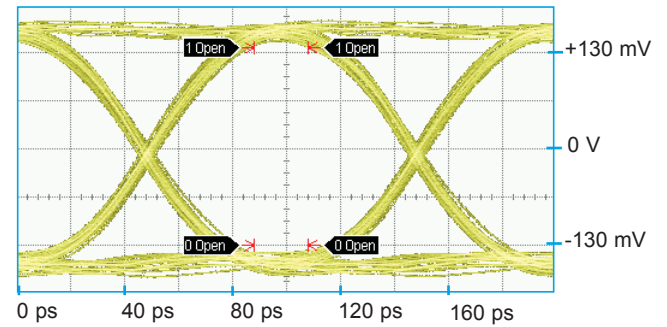

Eye Height	Eye Width	SNR	Jitter _{p-p}
268.2 mV	90.87 ps	21.62	7.56 ps

SERIES RF311/RF331

Normally Closed

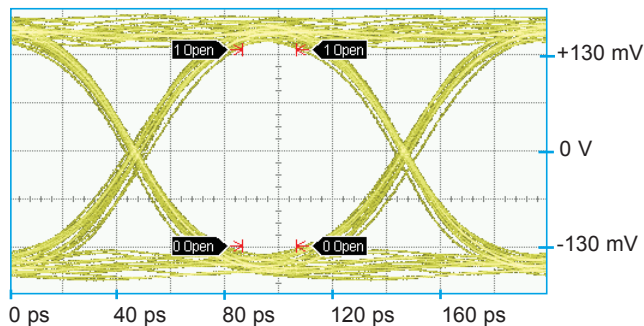

Eye Height	Eye Width	SNR	Jitter _{p-p}
266.5 mV	89.21 ps	19.44	9.78 ps

Normally Open

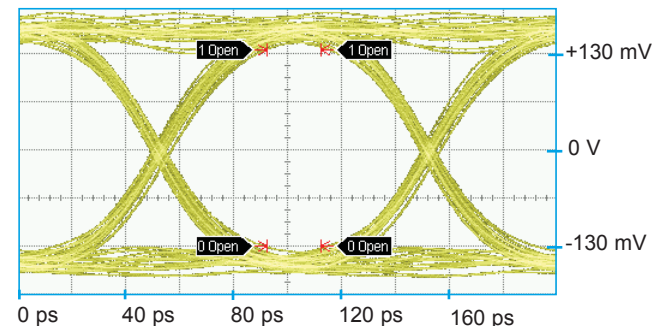

Eye Height	Eye Width	SNR	Jitter _{p-p}
264.3 mV	89.07 ps	19.13	8.00 ps

APPENDIX: SIGNAL INTEGRITY EYE DIAGRAMS

SERIES GRF311/GRF331

Normally Closed

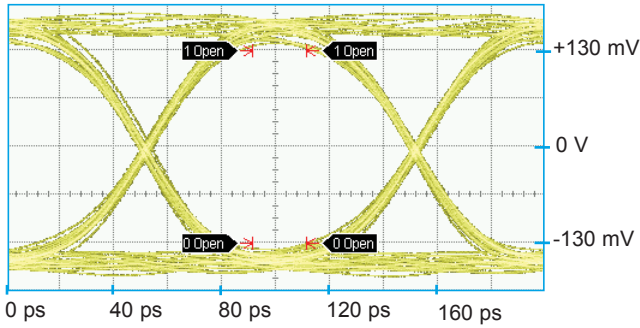

Eye Height	Eye Width	SNR	Jitter _{p-p}
260.0 mV	92.32 ps	17.98	6.67 ps

Normally Open

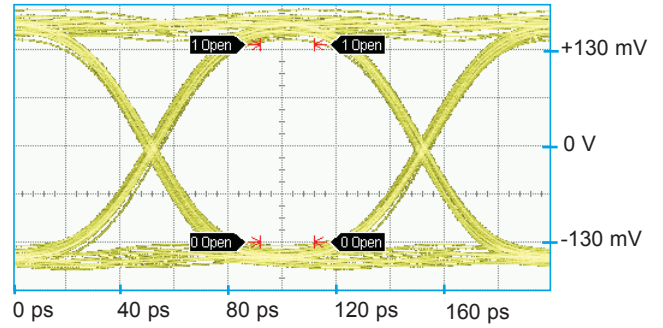

Eye Height	Eye Width	SNR	Jitter _{p-p}
267.2 mV	90.99 ps	20.84	7.11 ps

SERIES RF341

Normally Closed

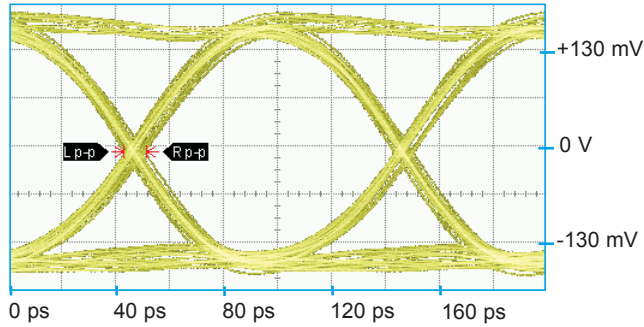

Eye Height	Eye Width	SNR	Jitter _{p-p}
260.9 mV	88.26 ps	18.39	8.44 ps

Normally Open

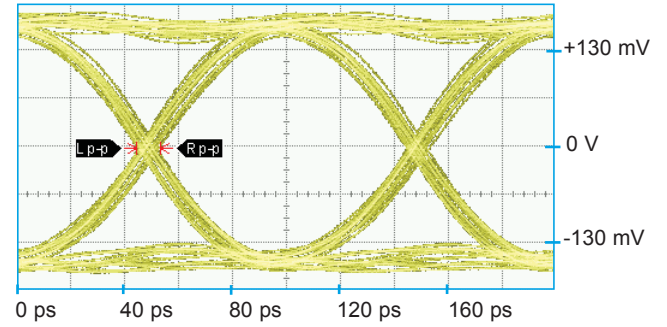

Eye Height	Eye Width	SNR	Jitter _{p-p}
271.5 mV	86.41 ps	21.35	8.89 ps

SERIES GRF341

Normally Closed

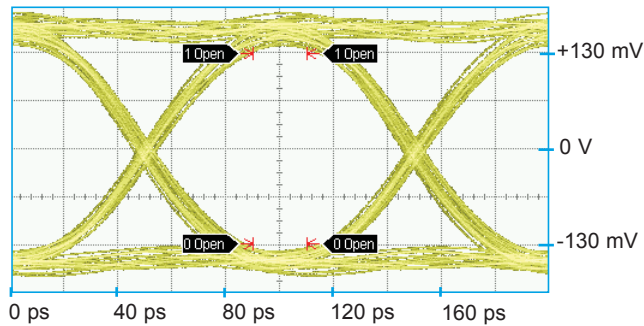

Eye Height	Eye Width	SNR	Jitter _{p-p}
256.2 mV	87.70 ps	17.15	8.89 ps

Normally Open

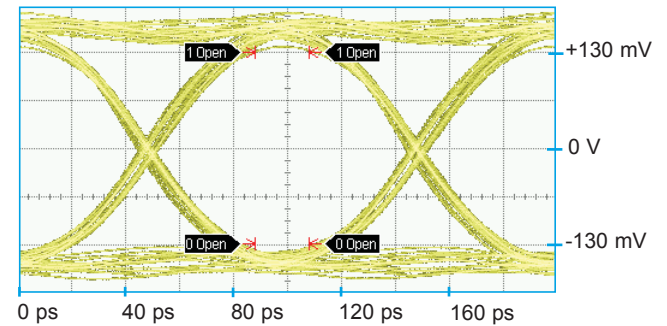

Eye Height	Eye Width	SNR	Jitter _{p-p}
259.9 mV	88.39 ps	17.59	8.00 ps

APPENDIX: SIGNAL INTEGRITY EYE DIAGRAMS

SERIES GRF342

Normally Closed

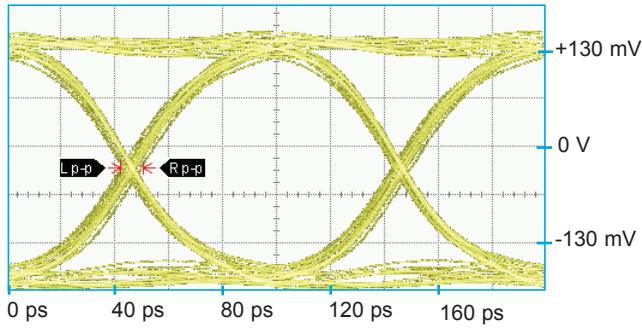

Eye Height	Eye Width	SNR	Jitter _{p-p}
252.9 mV	90.74 ps	16.53	8.44 ps

Normally Open

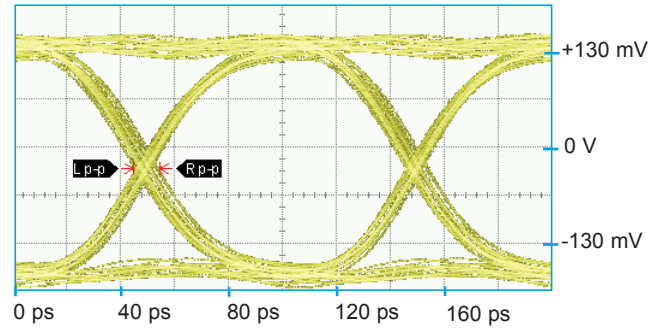

Eye Height	Eye Width	SNR	Jitter _{p-p}
253.1 mV	87.31 ps	17.57	9.78 ps

SERIES RF180

Normally Closed

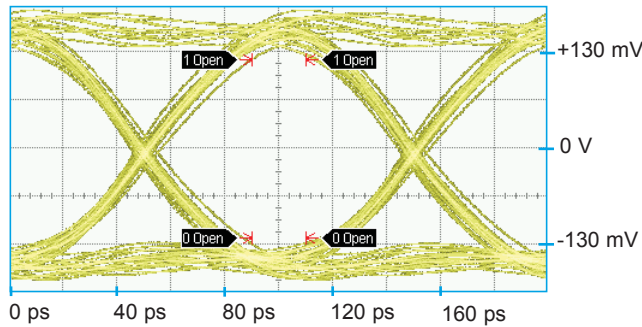

Eye Height	Eye Width	SNR	Jitter _{p-p}
240.5 mV	88.16 ps	13.86	10.67 ps

Normally Open

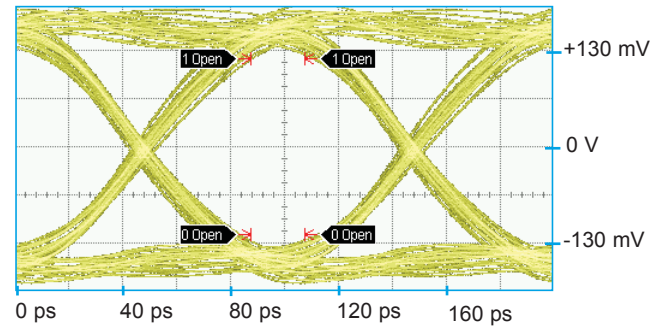

Eye Height	Eye Width	SNR	Jitter _{p-p}
235.8 mV	87.22 ps	12.75	10.22 ps

SERIES GRF180

Normally Closed

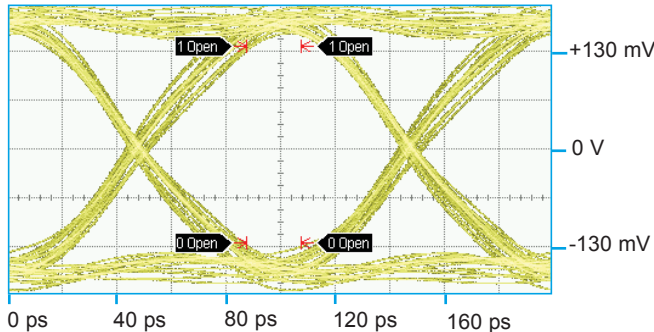

Eye Height	Eye Width	SNR	Jitter _{p-p}
262.1 mV	87.07 ps	15.18	9.78 ps

Normally Open

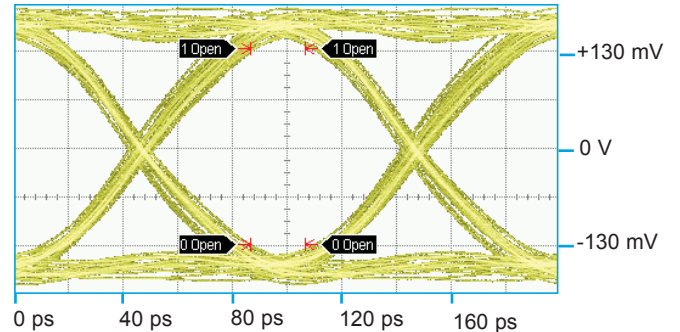

Eye Height	Eye Width	SNR	Jitter _{p-p}
260.6 mV	87.05 ps	16.26	10.22 ps

APPENDIX: SIGNAL INTEGRITY EYE DIAGRAMS

SERIES RF424

Typical Path

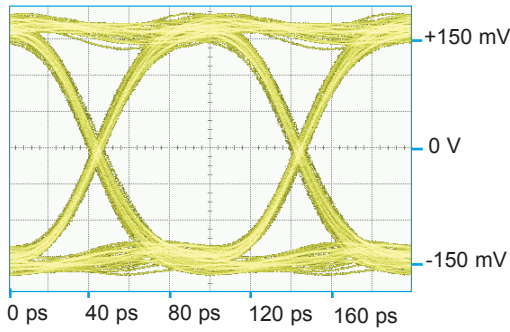

Eye Height	Eye Width	SNR	Jitter _{P-P}
254.0 mV	90.27 ps	15.61	8.89 ps

SERIES GRF424

Normally Closed

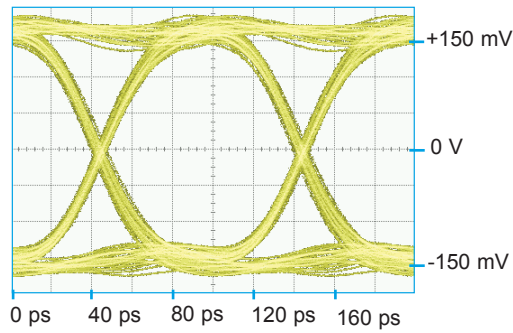

Eye Height	Eye Width	SNR	Jitter _{P-P}
254.0 mV	90.27 ps	15.61	8.89 ps

SERIES SGRF424

Normally Closed

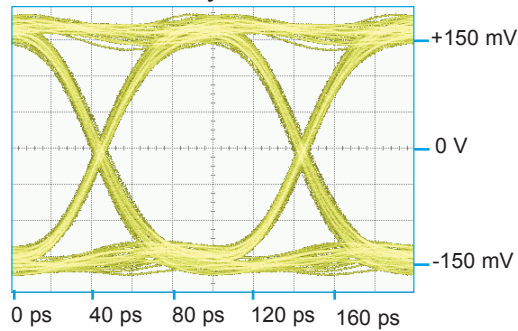

Eye Height	Eye Width	SNR	Jitter _{P-P}
254.0 mV	90.27 ps	15.61	8.89 ps

APPENDIX: SIGNAL INTEGRITY EYE DIAGRAMS

SERIES RF310/RF313

Normally Closed

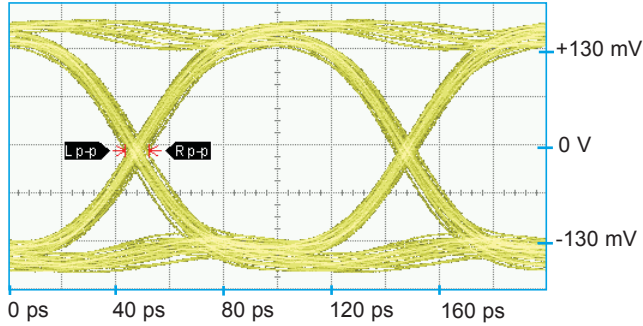

Eye Height	Eye Width	SNR	Jitter _{p-p}
246.1 mV	92.45 ps	14.59	6.22 ps

Normally Open

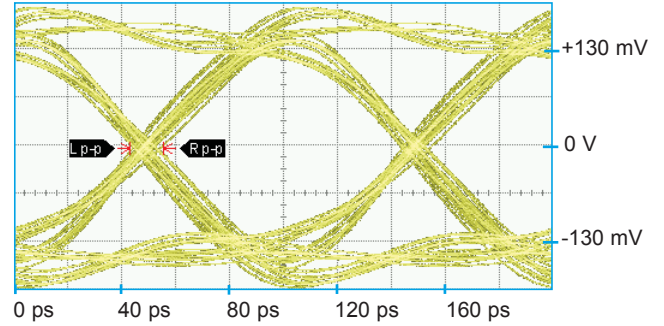

Eye Height	Eye Width	SNR	Jitter _{p-p}
268.2 mV	90.87 ps	21.62	7.56 ps

SERIES RF320/RF323

Normally Closed

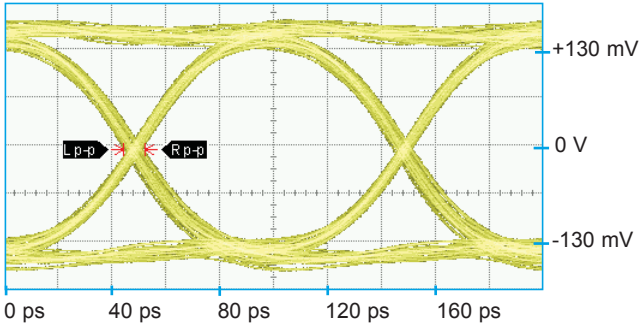

Eye Height	Eye Width	SNR	Jitter _{p-p}
246.1 mV	92.45 ps	14.59	6.22 ps

Normally Open

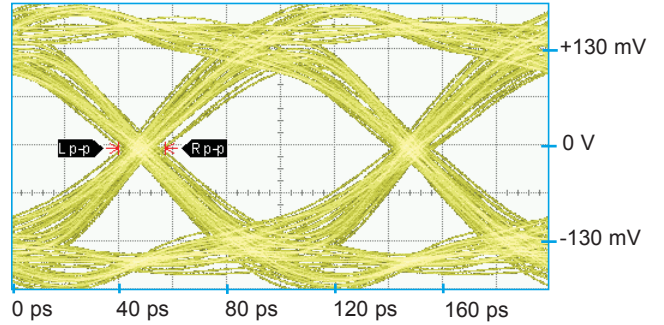

Eye Height	Eye Width	SNR	Jitter _{p-p}
268.2 mV	90.87 ps	21.62	7.56 ps

SERIES A150

Attenuated Path

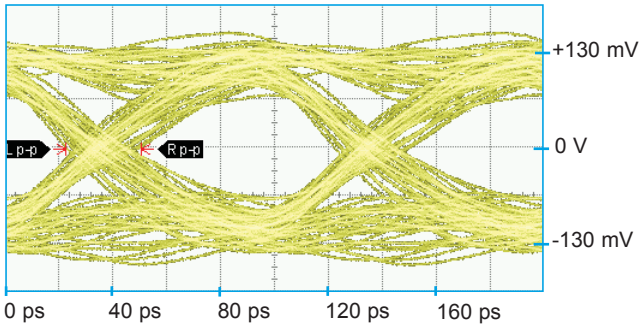

Eye Height	Eye Width	SNR	Jitter _{p-p}
45.59 mV	64.18 ps	5.70	28.00 ps

Thru Path

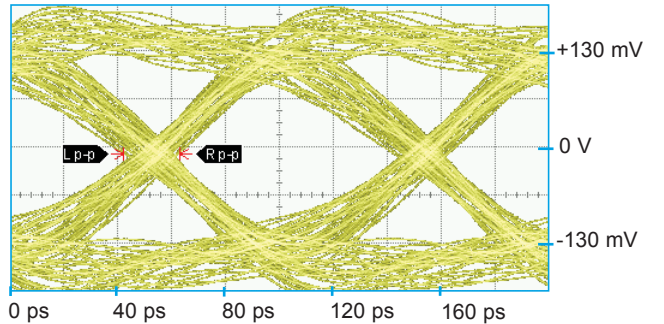

Eye Height	Eye Width	SNR	Jitter _{p-p}
130.2 mV	72.87 ps	5.29	20.89 ps

APPENDIX: SIGNAL INTEGRITY EYE DIAGRAMS

SERIES GA150

Attenuated Path

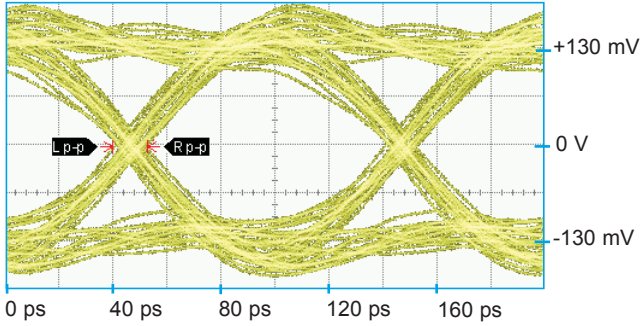

Eye Height	Eye Width	SNR	Jitter _{p-p}
62.10 mV	83.23 ps	7.14	12.89 ps

Thru Path

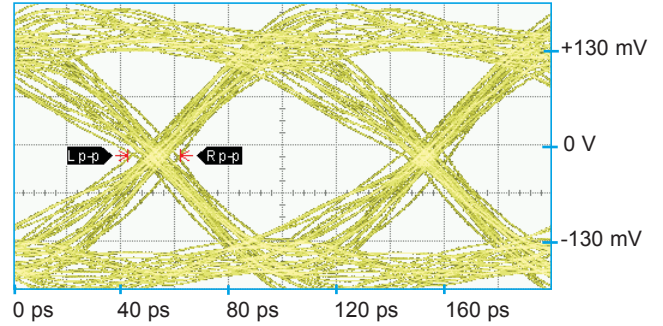

Eye Height	Eye Width	SNR	Jitter _{p-p}
130.3 mV	78.38 ps	5.30	19.56 ps

SERIES A152

Attenuated Path

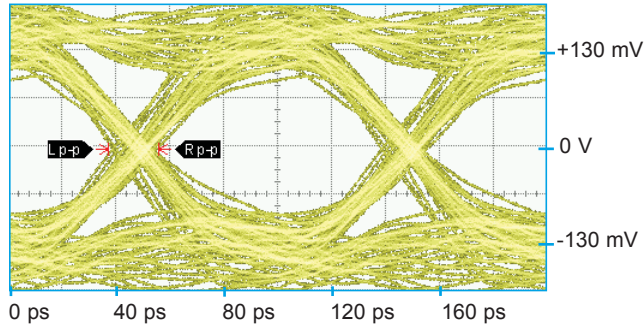

Eye Height	Eye Width	SNR	Jitter _{p-p}
45.10 mV	78.94 ps	5.57	18.67 ps

Thru Path

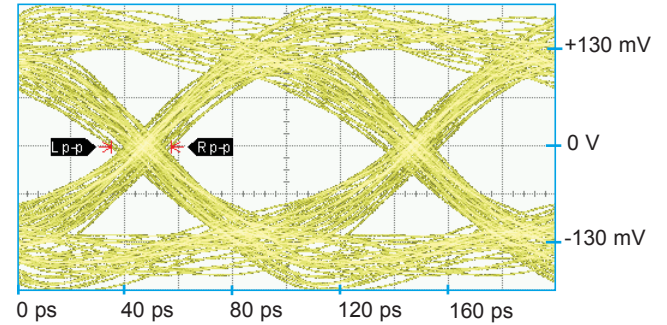

Eye Height	Eye Width	SNR	Jitter _{p-p}
124.5 mV	73.90 ps	5.23	22.22 ps

SERIES GA152

Attenuated Path

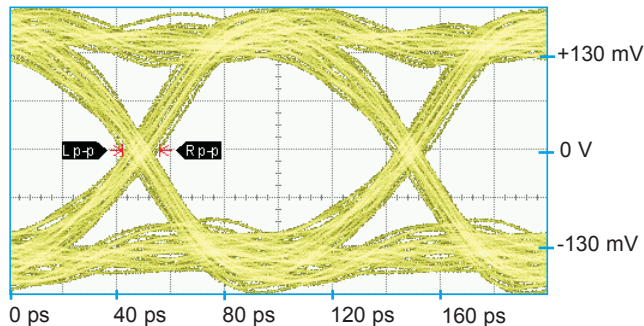

Eye Height	Eye Width	SNR	Jitter _{p-p}
67.99 mV	82.70 ps	7.85	13.78 ps

Thru Path

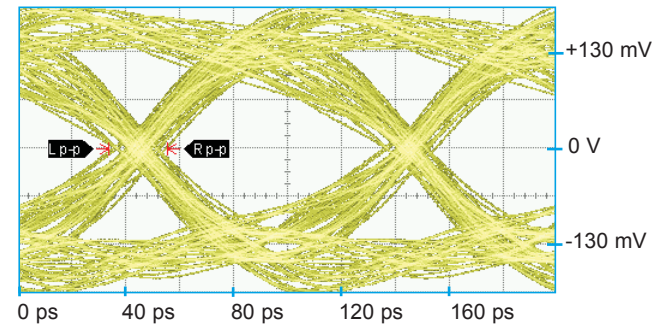

Eye Height	Eye Width	SNR	Jitter _{p-p}
122.9 mV	76.21 ps	5.07	21.78 ps

PATTERN GENERATOR SETTINGS

10 Gbps Random Pulse Pattern Generator
 2³¹ - 1 PRBS signal
 PRBS output of 300mV_{p-p} (nominal)
 RF PCB effect (negligible) not removed from measurement
 Data shown is typical of both poles

RoHS and REACH CERTIFICATE OF COMPLIANCE

RoHS

It is hereby stated and certified that Teledyne Relays complies with the Restrictions on Hazardous Substances, RoHS 2 Directive (2011/65/EU) to the extent herein: Teledyne Relays does not use any of the Restricted Substances specified by the RoHS Directives (listed below) as components in TO-5 and Centigrid® Electromechanical Relay products, nor are these substances employed during any electromechanical relay manufacturing process:

- Lead
- Mercury
- Cadmium
- Hexavalent Chromium
- Polybrominated Biphenyls (PBB's)
- Polybrominated Diphenyl Ethers (PBDE's)
- 2-ethylhexyl) phthalate (DEHP)
- Butyl benzyl phthalate (BBP)
- Dibutyl phthalate (DBP)
- Diisobutyl phthalate (DIBP)

However, upon request from the Customer, relay leads may be coated with solder, which contains 60% tin and 40% lead.

REACH

It is hereby stated and certified that Teledyne Relays complies with the Registration Evaluation Authorization and Restriction of Chemicals (REACH) Directives to the extent stated herein:

Teledyne Relays is a manufacturer of articles. Teledyne Relays has taken the initiative to review the (174) substances that are under consideration for treatment as Substances of Very High Concern (SVHC) candidates. Teledyne Relays confirmed that our relays do not contain any of the listed substances in concentration >0.1% weight per supplied article, substance or preparation weight.



RoHS or Non-RoHS:
Your Choice!



**TELEDYNE
RELAYS**
Everywhereyoulook™

For Additional Information please E-Mail us at: relays@teledyne.com

APPENDIX: TELEDYNE RELAYS PART NUMBERING SYSTEM

LoopBack Relays

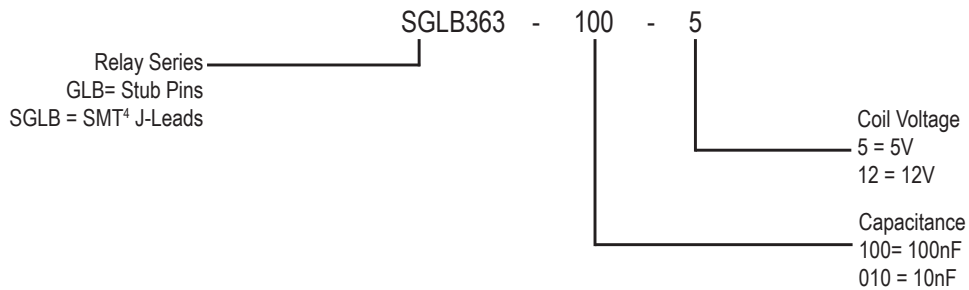
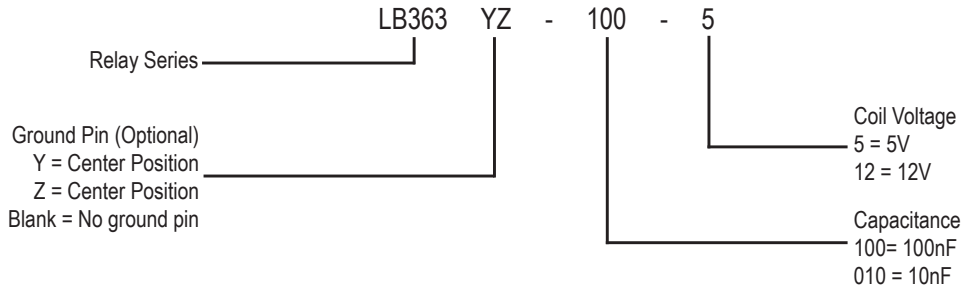

RF Relays (Except Attenuator Relays)

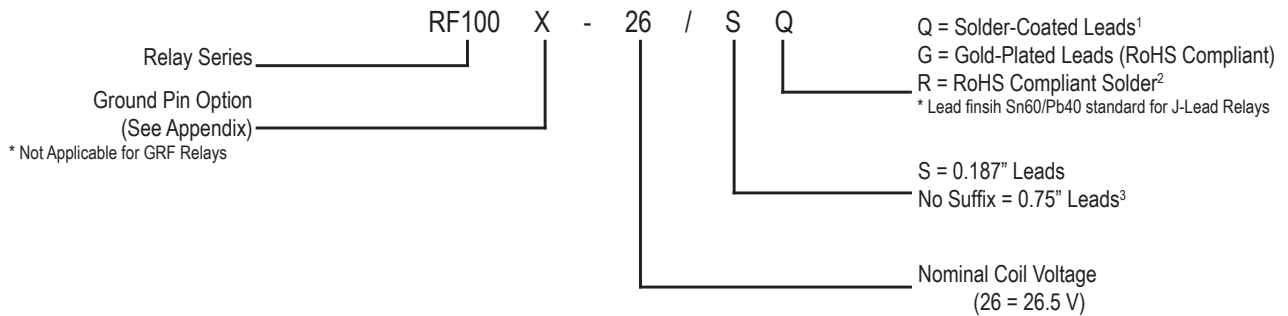

T²R Established Reliability Relays

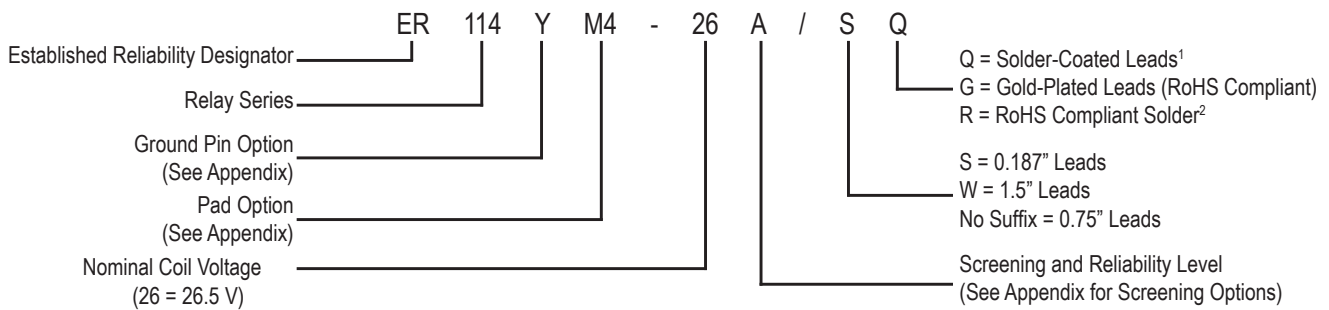

General Note: Parts ordered without suffix may be supplied with Solder-Coated or Gold-Plated leads

¹ Parts ordered with Solder-Coated leads will have (Sn60/Pb40)

² Parts ordered with RoHS Solder-Coated leads will have (Sn99.3/Cu0.7)

³ Not Applicable to GRF relays

⁴ SMT=Surface Mount Technology

APPENDIX: TELEDYNE RELAYS PART NUMBERING SYSTEM

Military Qualified (JAN) Relays

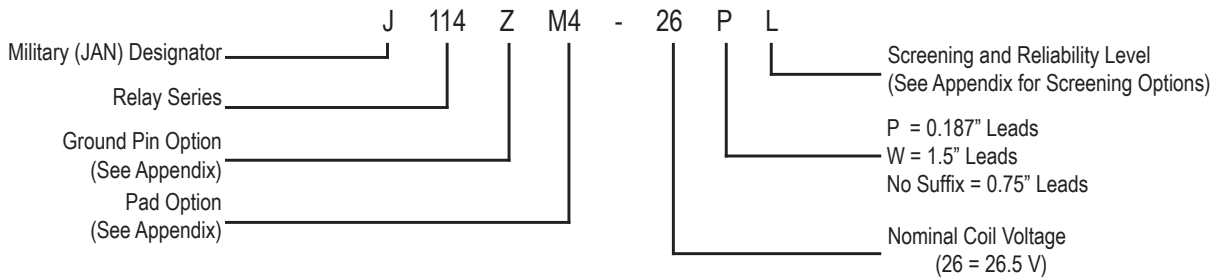

Commercial Surface Mount Relays

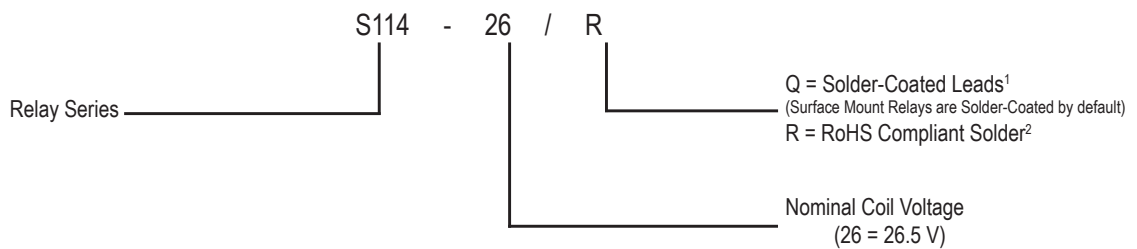

Commercial Relays, (Except Surface Mount Relays)

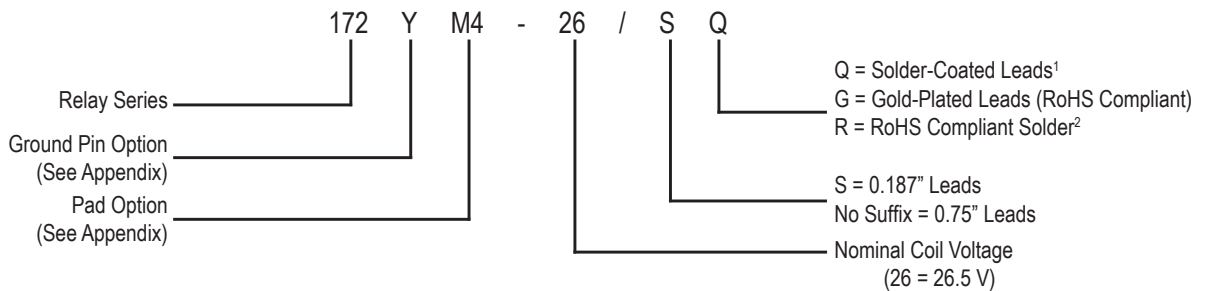

High Performance Relays

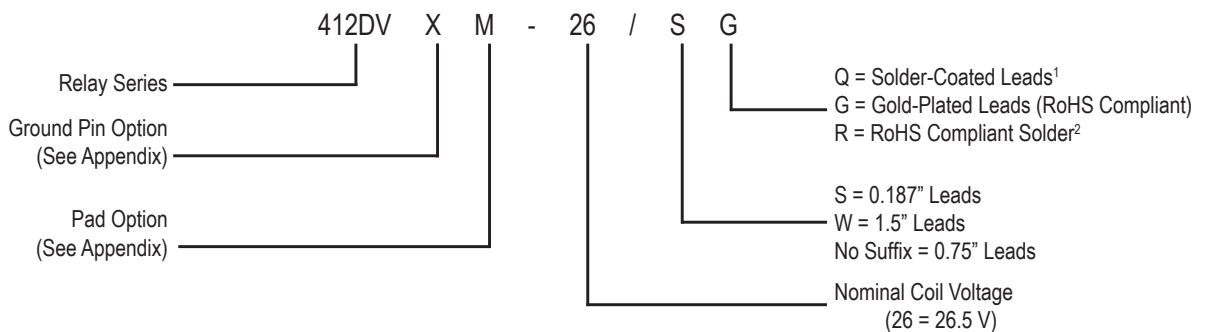

General Note: Parts ordered without suffix may be supplied with Solder-Coated or Gold-Plated leads.

¹ Parts ordered with Solder-Coated leads will have (Sn60/Pb40)

² Parts ordered with RoHS Solder-Coated leads will have (Sn99.3/Cu0.7)

APPENDIX: TELEDYNE RELAYS DIMENSIONS

TO-5 Package Relays (Through Hole)

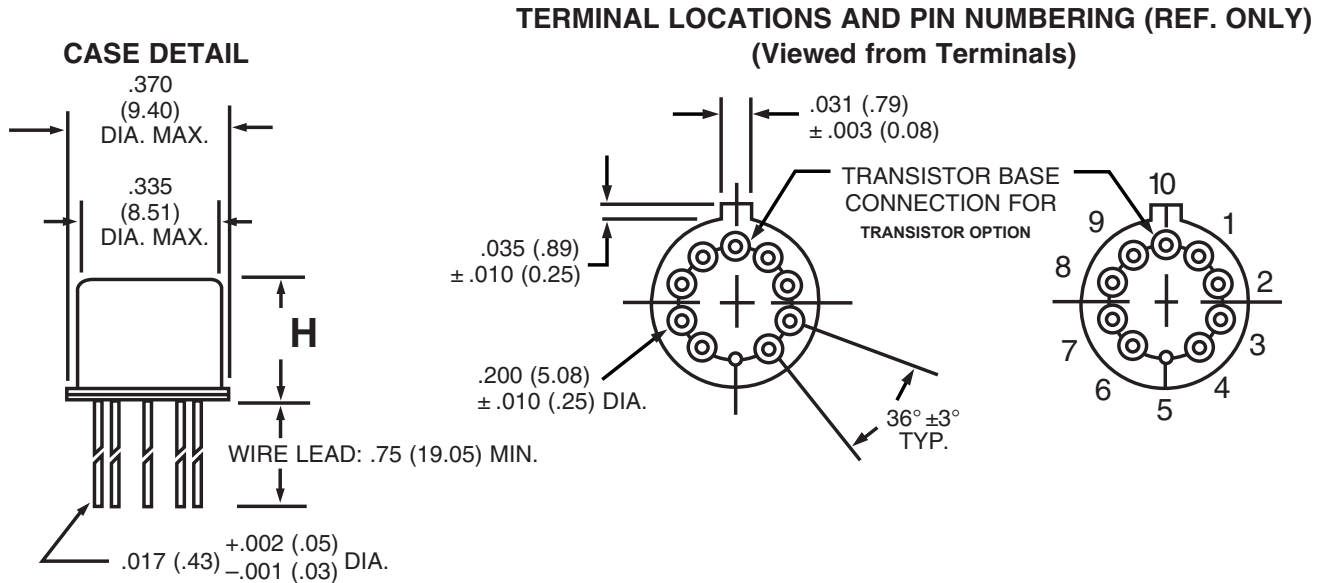

"H" Dimension Max inches (mm)	Applicable Relay Series:
0.270 (6.86)	412, 412D, 412DD, 412T
0.275 (6.99)	712, 712D, 712TN, RF300, RF300D, RF300DD, RF310, RF320, RF700
0.280 (7.11)	722, 722D, RF341, 420, 420D, 420DD, 421, 421D, 421DD, 422, 422D, 422DD
0.325 (8.26)	RF312, SI800, RF424, RF424D
0.375 (9.52)	432, 432D, 432DD, 432T
0.385 (9.76)	732, 732D, 732TN, RF303, RF303D, RF303DD, RF313, RF323
0.400 (10.16)	RF332, SI803

APPENDIX: TELEDYNE RELAYS DIMENSIONS

TO-5 Package Relays (Through Hole)

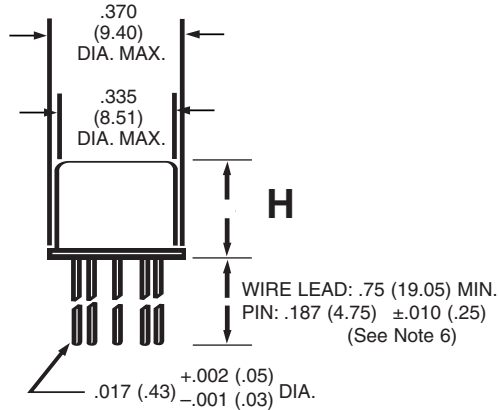

TERMINAL LOCATIONS AND PIN NUMBERING (REF. ONLY) (Viewed from Terminals)

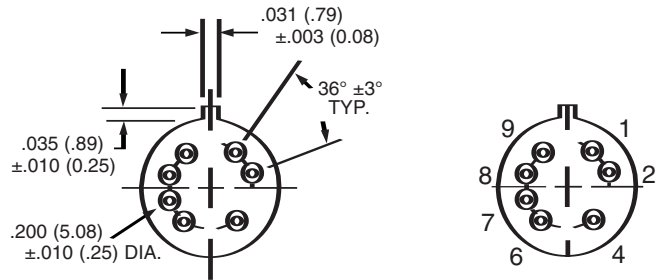

DIMENSIONS ARE SHOWN IN INCHES (MILLIMETERS)

“H” Dimension Max inches (mm)

Applicable Relays:

0.280 (7.11)

RF341, ER421, ER421D, ER421DD, J421, J421D, J421DD

CASE DETAIL

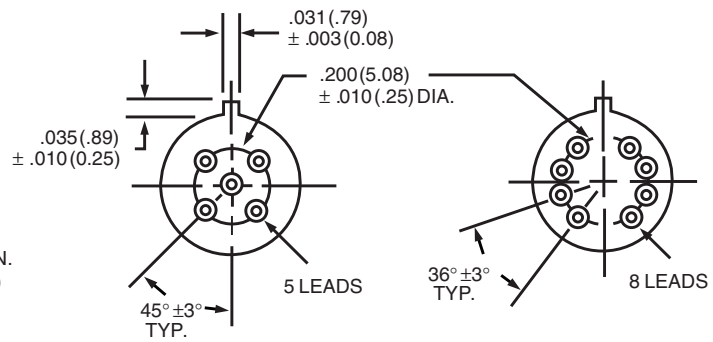
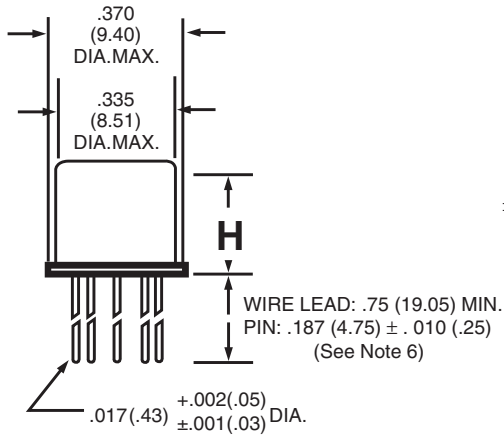

411, 411D, 411DD
431, 431D, 431DD
RF311
RF331

411T
431T

“H” Dimension Max inches (mm)

Applicable Relays:

0.270 (6.86)

411, 411D, 411DD, 411T

0.275 (6.99)

RF311

0.375 (9.52)

431, 431D, 431DD, 431T

0.385 (9.78)

RF331

APPENDIX: TELEDYNE RELAYS DIMENSIONS

TO-5 Package Relays (Surface Mount)

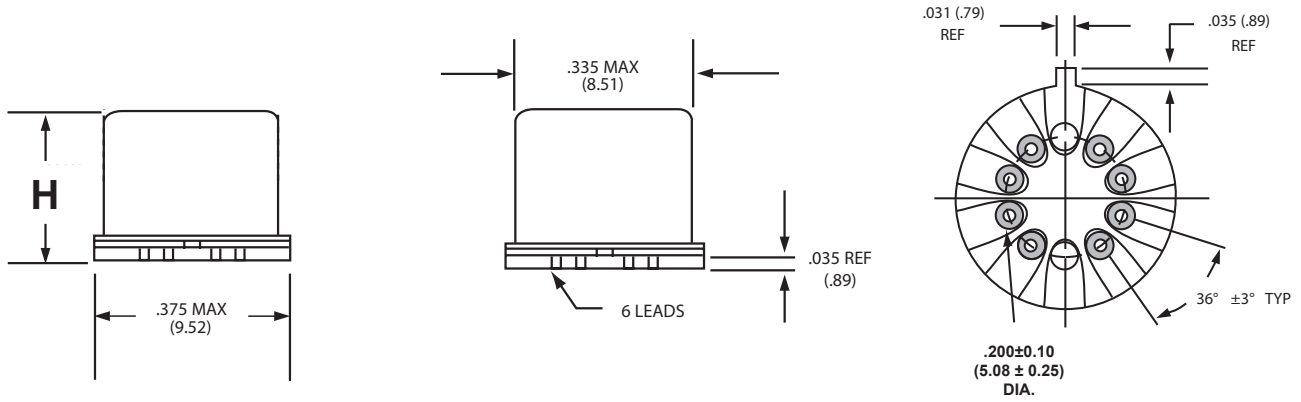

"H" Dimension Max inches (mm)	Applicable Relays:
0.315 (8.00)	GRF300
0.320 (8.13)	GRF342
0.365 (9.27)	GRF312, GRF424, GRF424D
0.425 (10.80)	GRF303
0.450 (11.43)	GRF332

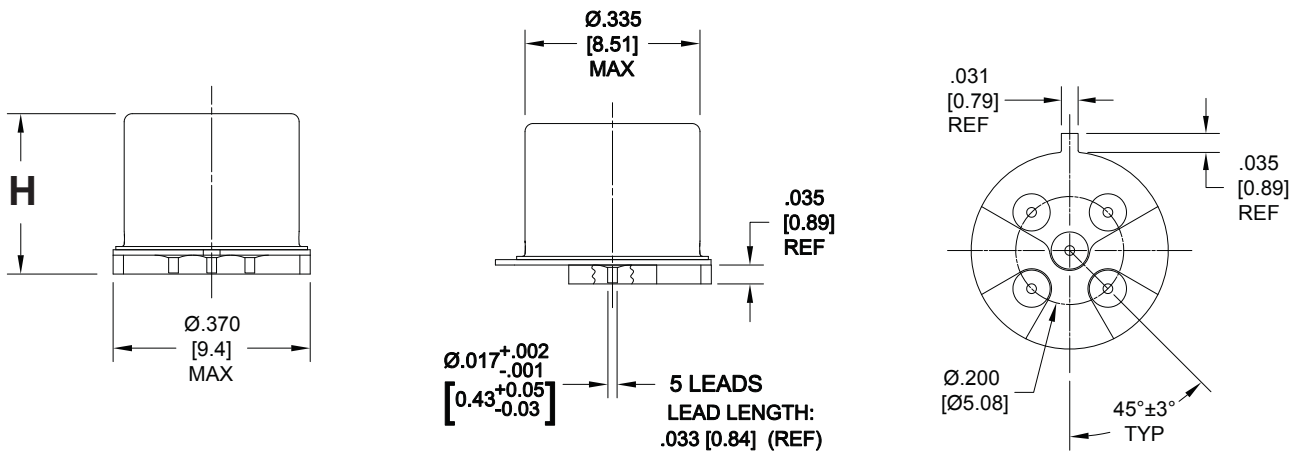

"H" Dimension Max inches (mm)	Applicable Relays:
0.315 (8.00)	GRF311

APPENDIX: TELEDYNE RELAYS DIMENSIONS

TO-5 Package Relays (J-Lead Surface Mount)

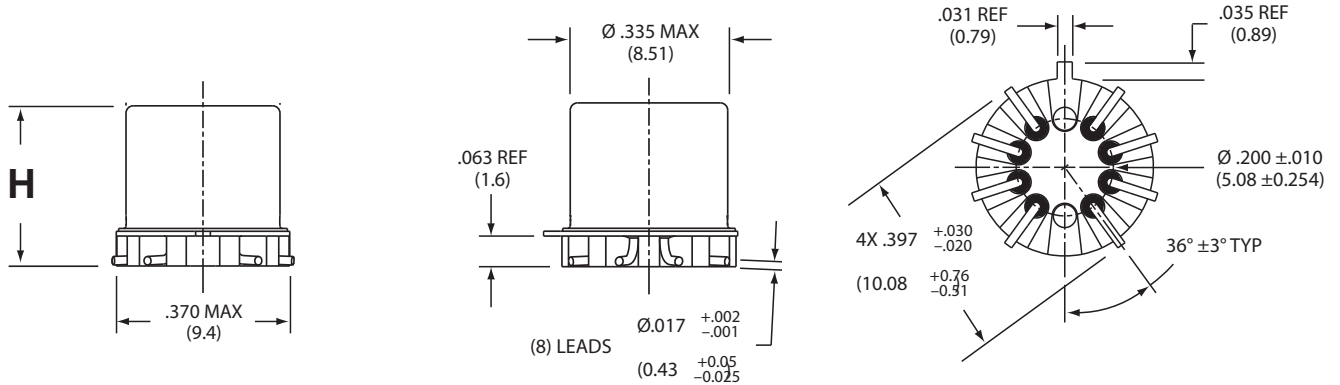

"H" Dimension Max inches (mm)	Applicable Relays:
0.340 (8.64)	SGRF300
0.390 (9.91)	SGRF312, SGRF424, SGRF424D
0.440 (11.18)	SGRF303
0.465 (11.81)	SGRF332

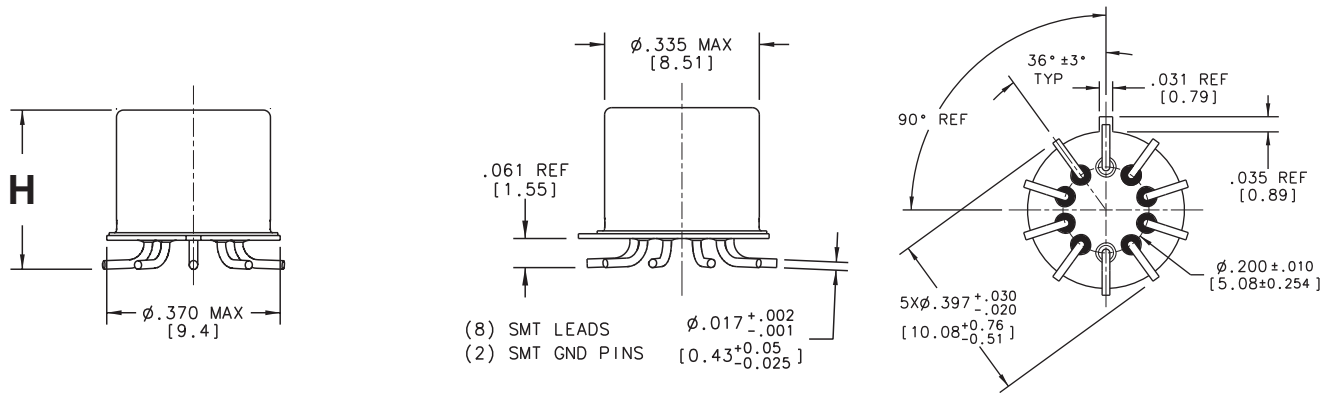

"H" Dimension Max inches (mm)	Applicable Relays:
0.340 (8.64)	SRF300
0.345 (8.76)	S422, S422D, S422DD
0.460 (11.18)	SRF303

APPENDIX: TELEDYNE RELAYS DIMENSIONS

Centigrid® Package Relays (Through Hole)

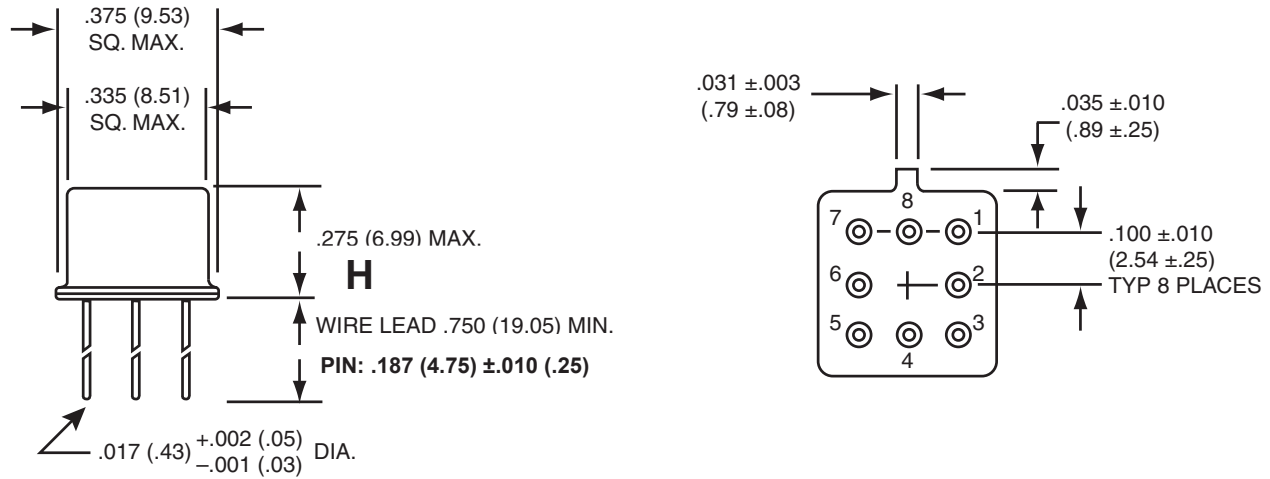

"H" Dimension Max inches (mm)	Applicable Relay Series:
0.275 (6.99)	114, 114D, 114DD
0.280 (7.11)	172, 172D
0.290 (7.37)	RF100
0.375 (9.53)	134, 134D, 134DD
0.395 (10.03)	RF103

Centigrid® Package Relays (Surface Mount)

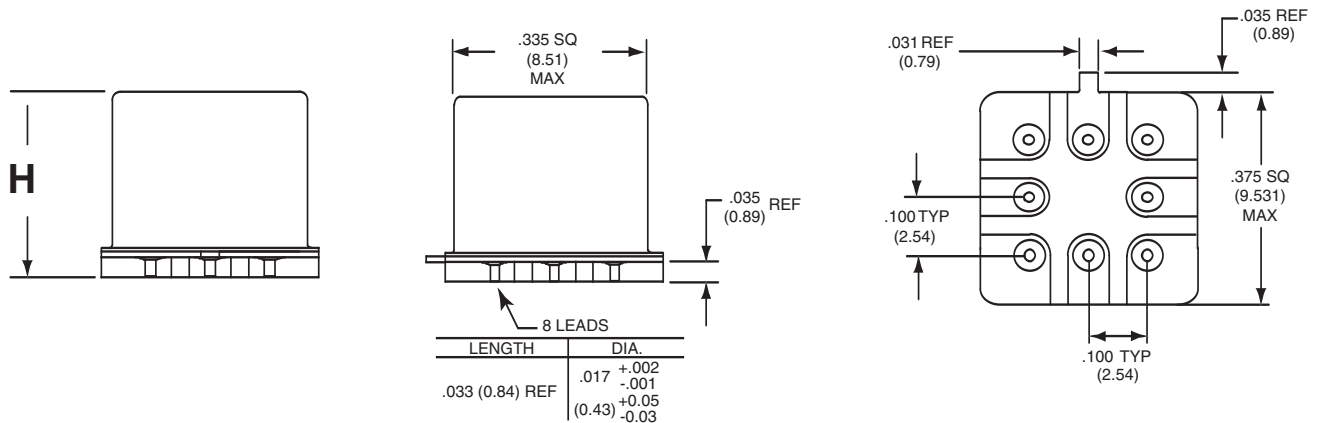

"H" Dimension Max inches (mm)	Applicable Relay Series:
0.330 (8.38)	GRF100, GRF172, GRF172D
0.435 (11.05)	GRF103

APPENDIX: TELEDYNE RELAYS DIMENSIONS

Centigrid® Package Relays (J-Lead Surface Mount)

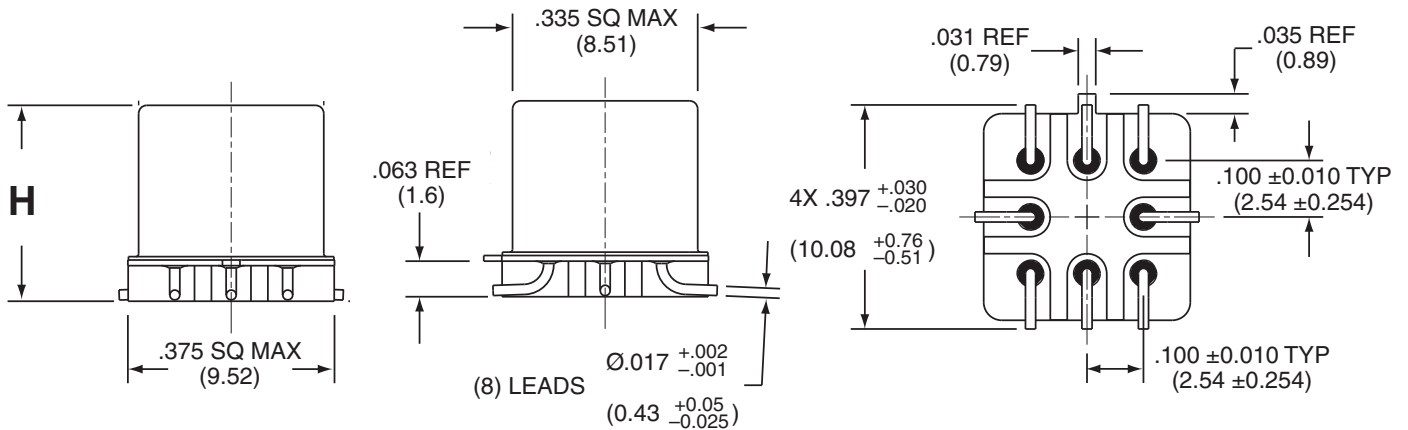

"H" Dimension Max inches (mm)	Applicable Relay Series:
0.355 (9.02)	SGRF100
0.460 (11.68)	SGRF103

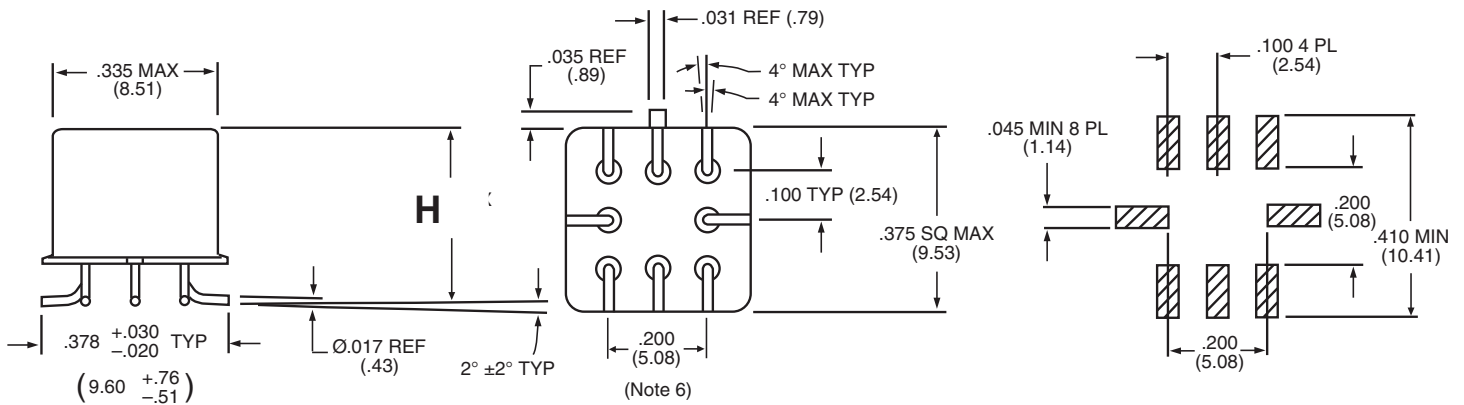

"H" Dimension Max inches (mm)	Applicable Relay Series:
0.360 (9.14)	S114, S114D, S114DD
0.370 (9.40)	S172, S172D
0.460 (11.68)	S134, S134D, S134DD

APPENDIX: TELEDYNE RELAYS DIMENSIONS

Extended Centigrad® Package Relays (RF121 - Through Hole)

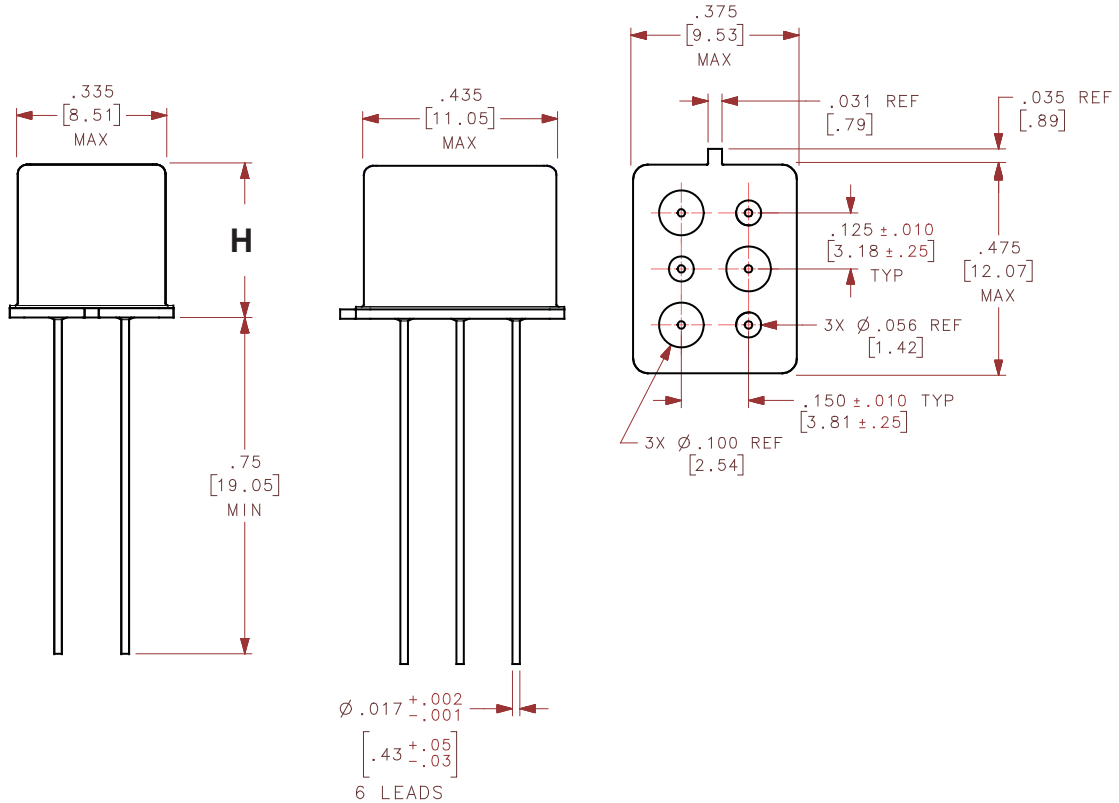

"H" Dimension Max inches (mm)		Applicable Relay Series:
0.345 (8.77)		RF121

Extended Centigrad® Package Relays (GRF121 - Surface Mount)

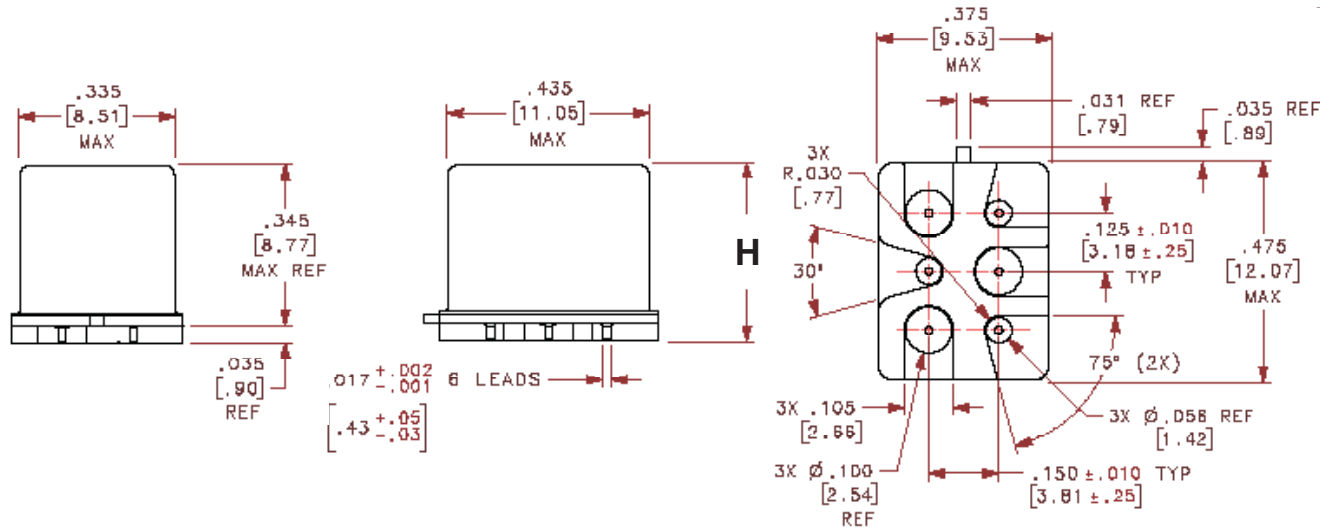

"H" Dimension Max inches (mm)		Applicable Relay Series:
0.385 (9.78)		GRF121

APPENDIX: TELEDYNE RELAYS DIMENSIONS

Extended Centigrid® Package Relays (Through Hole)

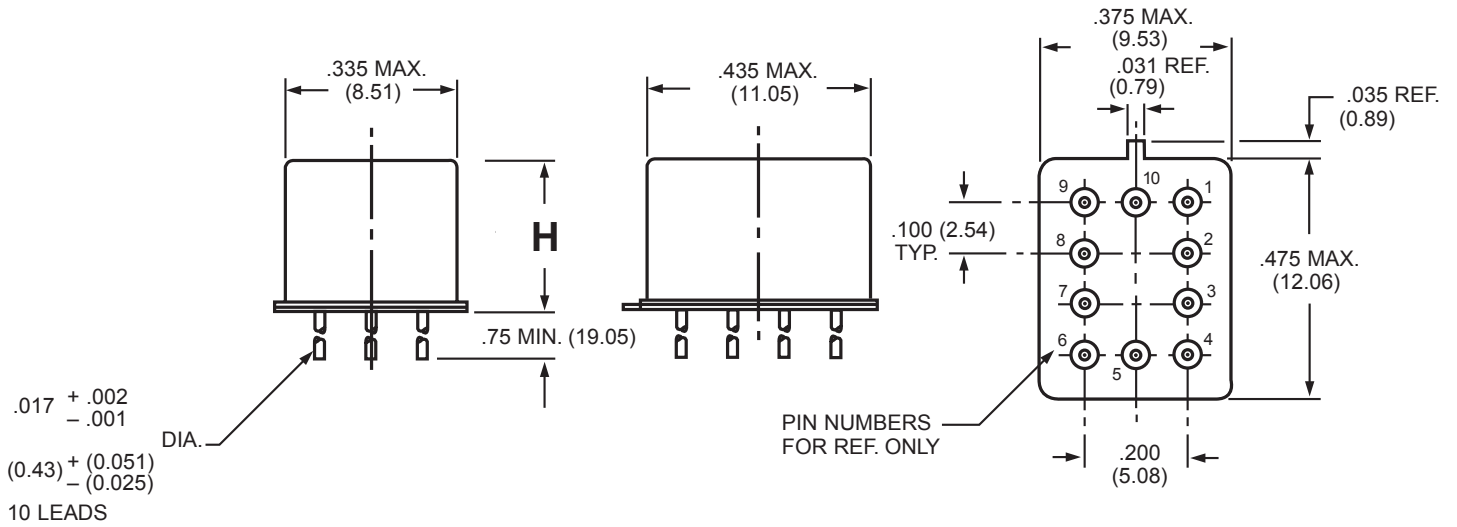

"H" Dimension Max inches (mm)	Applicable Relay Series:
0.295 (7.49)	122C
0.300 (7.62)	RF180

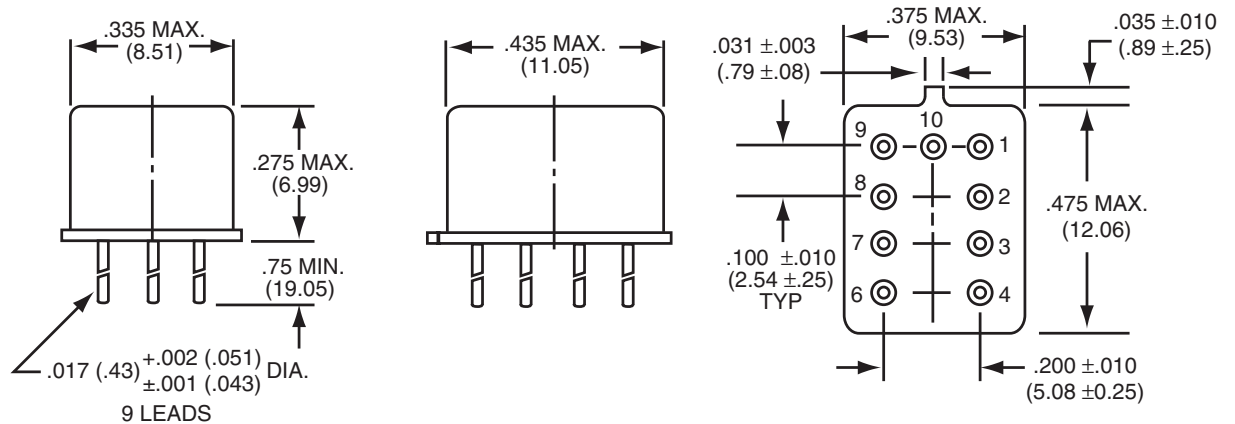

"H" Dimension Max inches (mm)	Applicable Relay Series:
0.275 (6.99)	116C
0.375 (9.53)	136C

APPENDIX: TELEDYNE RELAYS DIMENSIONS

Extended Centigrid® Package Relays (Through Hole)

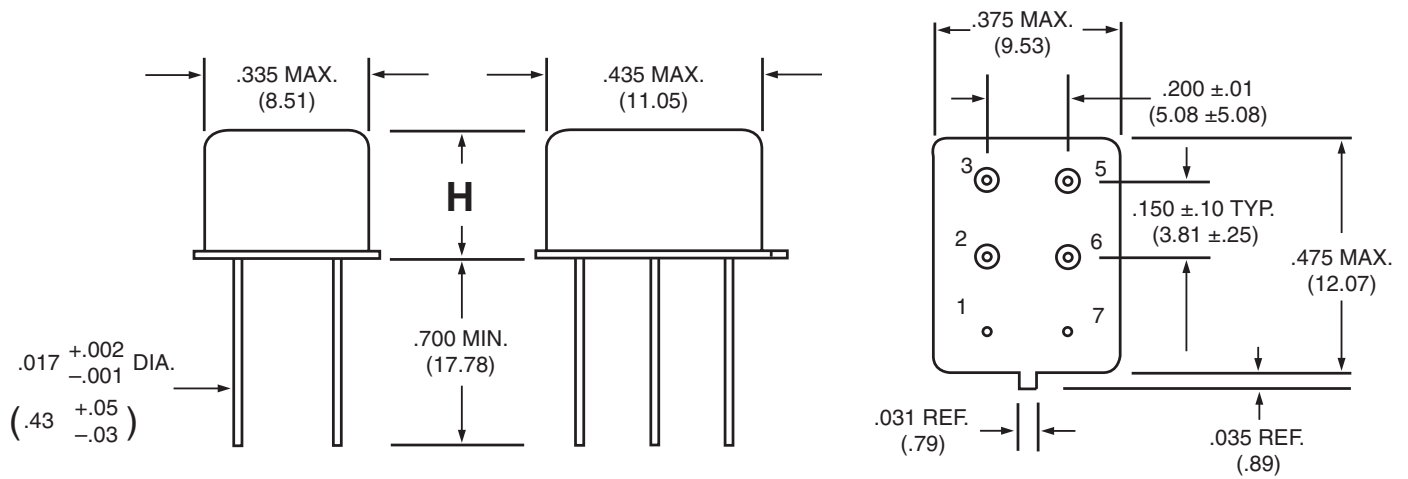

"H" Dimension Max inches (mm)	Applicable Relay Series:
0.280 (7.11)	A150
0.295 (7.49)	A152

Extended Centigrid® Package Relays (Surface Mount)

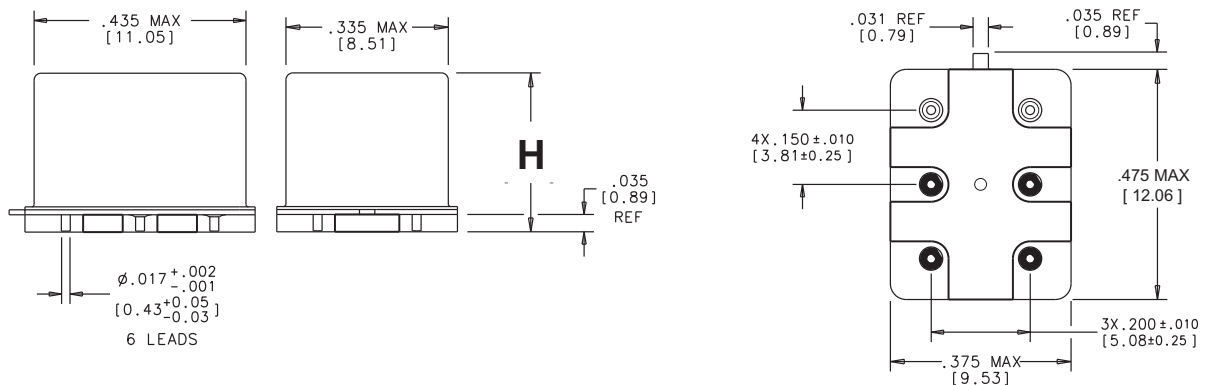

"H" Dimension Max inches (mm)	Applicable Relay Series:
0.335 (8.51)	GA152

APPENDIX: TELEDYNE RELAYS DIMENSIONS

LoopBack Package Relays (Through Hole)

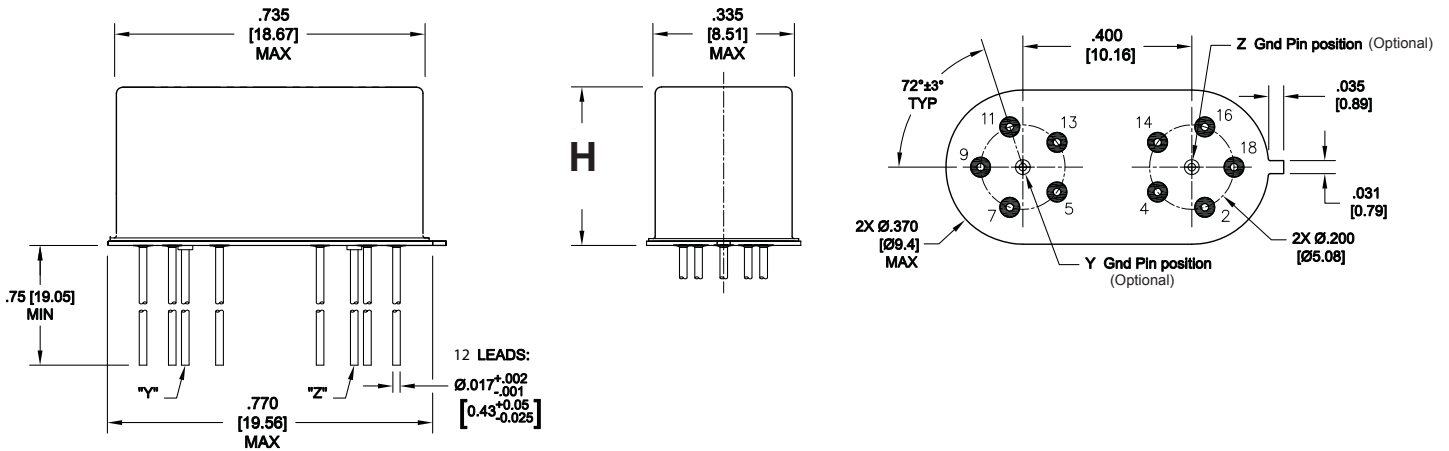

“H” Dimension Max
inches (mm)

Applicable Relay Series:

0.375 (9.52)

LB363

LoopBack Package Relays (Surface Mount)

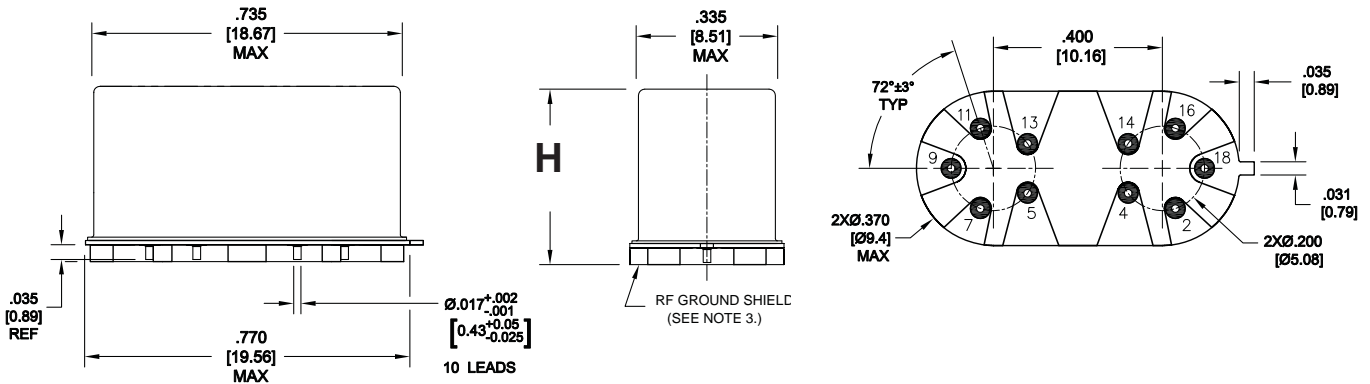

“H” Dimension Max
inches (mm)

Applicable Relay Series:

0.415 (10.54)

GLB363

APPENDIX: TELEDYNE RELAYS DIMENSIONS

LoopBack Package Relays (J-Lead Surface Mount)

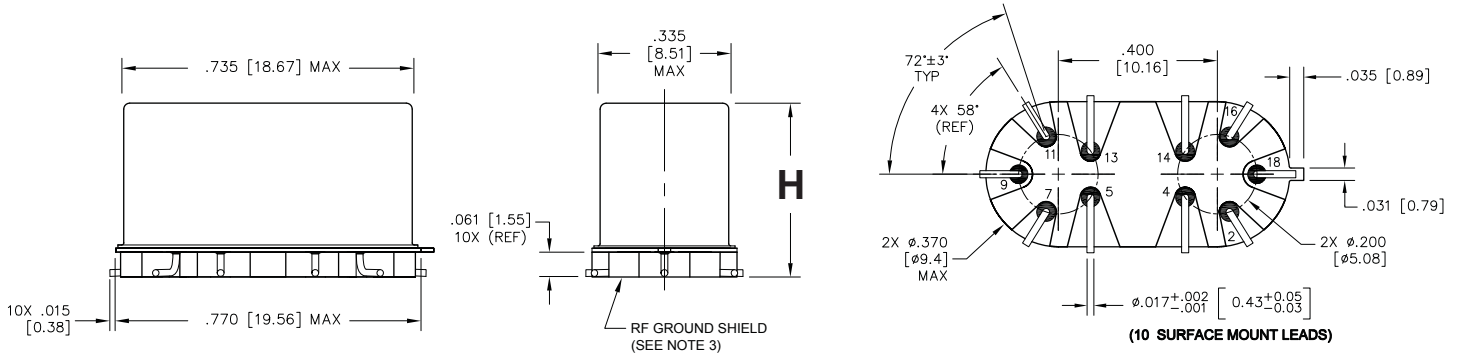

“H” Dimension Max inches (mm)	Applicable Relay Series:
0.443 (11.25)	SGLB363

Half-Size Crystal Can Package Relays (Through Hole)

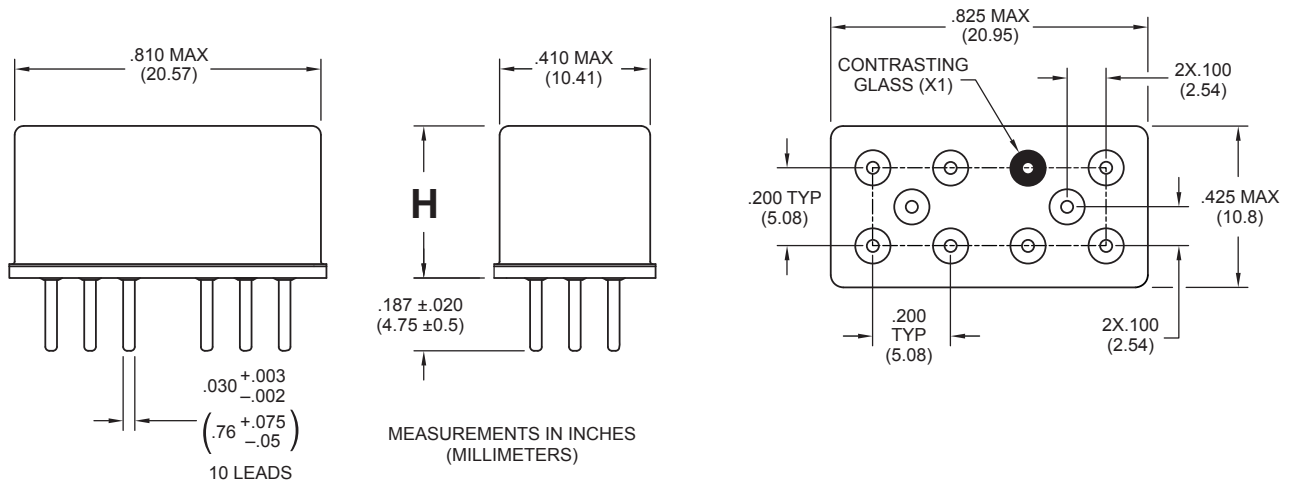

“H” Dimension Max inches (mm)	Applicable Relay Series:
0.410 (10.41)	255, 257, RF255, RF257

Handling Guidelines for TO-5 and Centigrid® Relays

- 1)** Do not drop, throw or in any way mishandle individual relays, cartons containing relay packs, or individual relay packs.
- 2)** Store unused relays in a humidity controlled, shock and vibration-free environment. Storage temperature range limits -65°C to + 125°C, however, when possible, relays should be stored in a 25°C environment.
- 3)** Observe normal good practice in the handling and storage of any relay packs marked as static sensitive.
- 4)** When removing relays from packaging, do so with care. If removing relays from Styrofoam packaging, remove relays carefully as pouring them from the packaging may cause damage to the relay. If removing from bulk packaging, gently pour the relays from the container, taking care to not allow the relays to drop from the container onto the new surface, to prevent unnecessary shock. Do not allow relays to fall onto the floor.
- 5)** When transferring relays to the production area after unpacking, do not drop, throw, or mishandle the relays in any way. When removing relays from the container, pouring is acceptable but again should be done gently and in a way as to not allow the relays to drop.
- 6)** Attached relay spreader pads and insulating pads should not be removed from the relays.
- 7)** Relays should not be exposed to any process or environment that exceeds any limits within this guide or any published specification that applies to the relay.
- 8)** Relays are hermetically sealed. Damaged to the casing or glass-to-metal seals will compromise the relays' performance and reliability.
- 9)** Never subject relays to ultrasonic cleaning environments.
- 10)** Unless otherwise specified, do not subject relays to solder reflow temperatures above 270°C, 1 minute maximum.
- 11)** Do not stack heavy object directly onto relays.
- 12)** Excessive handling of relay leads with bare hands, or exposure of the relay leads with other contaminating sources can compromise their solderability.
- 13)** Avoid exceeding 1-pound pull strength of the terminals.
- 14)** Avoid subjecting magnetic latching relays to large magnetic fields. Do not handle magnetic latching relays with magnetic holding tools.
- 15)** Avoid bending the flange, the base of the relays or bending/forming the leads in a manner which may result in deformation of the flange or base of the relays. Any such deformation, or handling, which results in visible deformations or dents to any part of the relays (including the cover) may compromise the precisely assembled internal parts of the relays, causing degradation of performance or potential permanent damage and may void the warranty.

APPENDIX: Spacer Pads

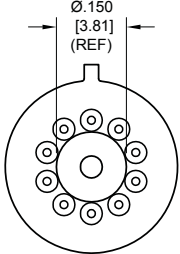
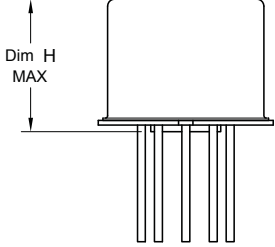
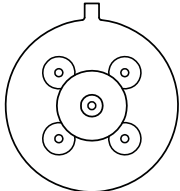
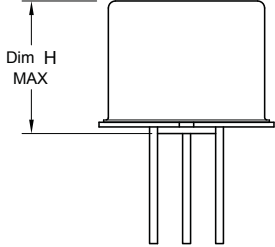
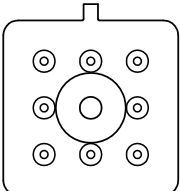
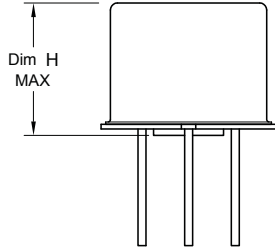
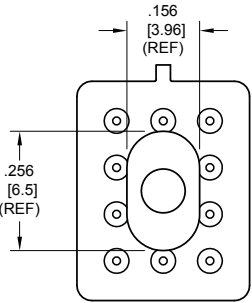
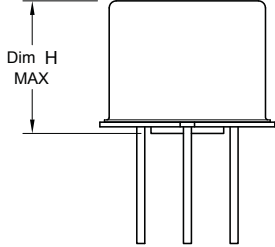
Pad designation and bottom view dimensions	Height	For use with the following:	Dim. H Max.
 <p style="text-align: center;">“M4” Pad for TO-5</p>		ER412, ER412D, ER412DD	.295 (7.49)
		712, 712D, 712TN, RF300, RF310, RF320 RF700, RF703	.300 (7.62)
		ER420, ER420D, ER420DD, 421, ER421D, ER421DD, ER422, ER422D, ER422DD, 722, 722D, RF341	.305 (7.75)
		ER431T, ER432T, ER432, ER432D, ER432DD	.400 (10.16)
		732, 732D, 732TN, RF303, RF313, RF323	.410 (10.41)
		RF312, RF332 SI800, SI803	.350 (8.89)
 <p style="text-align: center;">“M4” Pad for TO-5</p>		ER411, ER411D, ER411DD, ER411T	.295 (7.49)
		ER431, ER431D, ER431DD	.400 (10.16)
		RF311	.300 (7.62)
		RF331	.410 (10.41)
 <p style="text-align: center;">“M4” Pad for Centgrid®</p>		172, 172D	.305 (7.75)
		ER114, ER114D, ER114DD, J114, J114D, J114DD	.300 (7.62)
		ER134, ER134D, ER134DD, J134, J134D, J134DD	.400 (10.16)
		RF100	.315 (8.00)
		RF103	.420 (10.67)
 <p style="text-align: center;">“M9” Pad for Centgrid®</p>		122C, A152	.320 (8.13)
		ER116C, J116C	.300 (7.62)
		ER136C, J136C	.400 (10.16)
		RF180	.325 (8.25)
		A150	.305 (7.75)

Notes:

1. Spacer pad material: Polyester film.
2. To specify an “M4” or “M9” spacer pad, refer to the mounting variants portion of the part numbering example in the applicable datasheet.
3. Dimensions are in inches (mm).
4. Unless otherwise specified, tolerance is $\pm .010$ ” (.25 mm).
5. Add 10 m Ω to the contact resistance shown in the datasheet.
6. Add 0.01 oz. (0.25 g) to the weight of the relay assembly shown in the datasheet.

APPENDIX: Spreader Pads

Pad designation and bottom view dimensions	Height	For use with the following:	Dim. H Max.
<p style="text-align: center;">“M” Pad <u>5/ 6/</u></p>		ER411T, J411T, ER412, ER412D ER412DD, J412, J412D, J412DD ER412T, J412T	.388 (9.86)
		712, 712D, 712TN	.393 (9.99)
		ER431T, J431T, ER432, ER432D ER432DD, J432, J432D, J432DD ER432T, J432T	.493 (12.52)
		732, 732D, 732TN	.503 (12.78)
		ER420, J420, ER420D, J420D ER420DD, J420DD, ER421, J421 ER421D, J421D, ER421DD J422D, ER422DD, J422DD, 722	.398 (10.11)
<p style="text-align: center;">“M2” Pad <u>7/ 8/</u></p>		ER411T ER412, ER412D, ER412DD J412, J412D, J412DD	.441 (11.20)
		712, 712D	.451 (11.46)
		ER421, ER421D, ER421DD 722, 732D	.451 (11.46)
		ER431T ER432, ER432D, ER432DD	.546 (13.87)
		732, 732D	.556 (14.12)
<p style="text-align: center;">“M3” Pad <u>5/ 6/ 9/</u></p>		ER411, ER411D, ER411DD, ER411TX ER412X, ER412DX, ER412DDX ER412TX	.388 (9.86)
		712X, 712DX, 712TNX	.393 (9.99)
		ER420X, ER420DX, ER420DDX ER421X, ER421DX, ER421DDX ER422X, ER422DX ER422DDX, 722X, 722DDX	.398 (10.11)
		ER431, ER431D, ER431DD ER431TX ER432X, ER432DX, ER432DDX ER432TX	.493 (12.52)
		732X, 732DX, 732TNX	.503 (12.78)

Notes:

1. Spreader pad material: Diallyl Phthalate.
2. To specify an “M”, “M2” or “M3” spreader pad, refer to the mounting variants portion of the part number example in the applicable datasheet.
3. Dimensions are in inches (mm).
4. Unless otherwise specified, tolerance is $\pm .010$ ” (0.25 mm).
- 5/. Add 25 m Ω to the contact resistance shown in the datasheet.
- 6/. Add .01 oz. (0.25 g) to the weight of the relay assembly shown in the datasheet.
- 7/. Add 50 m Ω to the contact resistance shown in the datasheet.
- 8/. Add 0.025 oz (0.71 g) to the weight of the relay assembly shown in the datasheet.
- 9/. M3 pad to be used only when the relay has a center pin (e.g. ER411M3-12A, 722XM3-26.)

APPENDIX: Ground Pin Positions

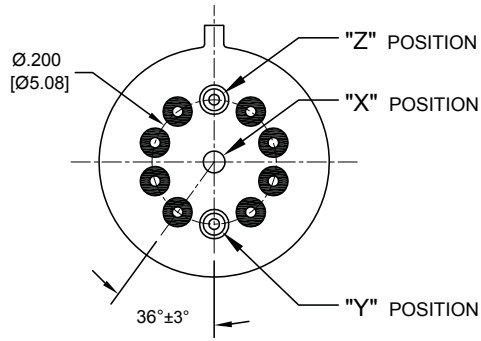

TO-5 Relays:

ER411T, ER412, ER412T, ER420, ER421, ER422, ER431T, ER432, ER432T, 712, 712TN, 400H, 400K, 400V, RF300, RF303, RF341, RF312, RF332, RF310, RF313, RF320, RF323, SI800, SI803, RF700, RF703

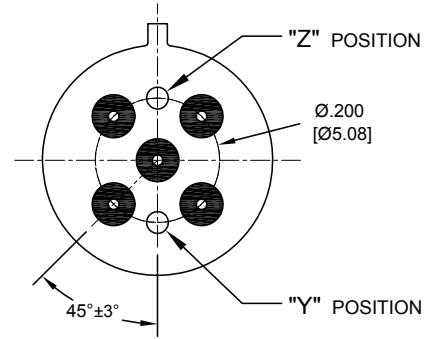

TO-5 Relays:

ER411, ER431, RF311, RF331

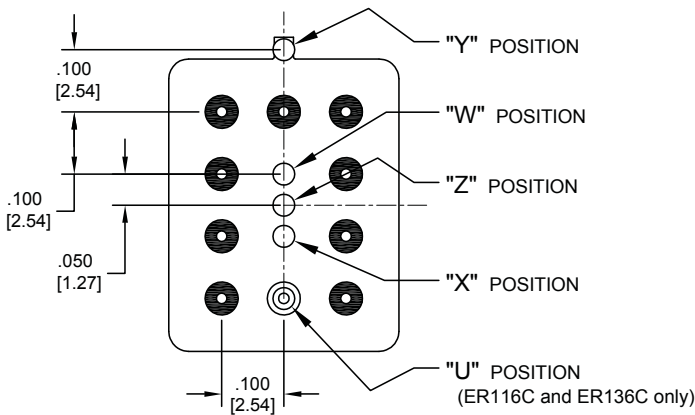

Centigrid® Relays:

RF180, ER116C, 122C, ER136C

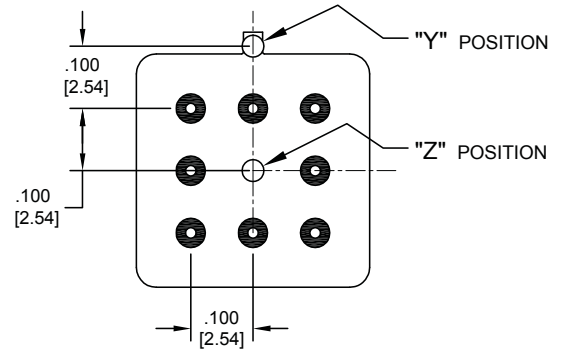

Centigrid® Relays:

RF100, RF103, ER114, ER134, 172

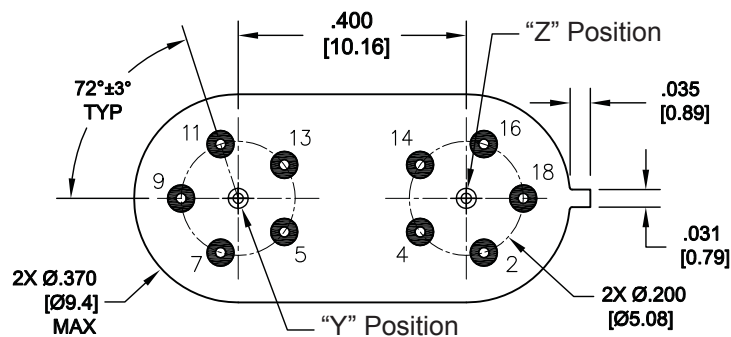

Loopback Relays:

LB363

NOTES

- Indicates ground pin position
- Indicates glass insulated lead position
- ◎ Indicates ground pin or lead position depending on relay type

1. Terminal views shown
2. Dimensions are in inches (mm)
3. Tolerances: $\pm .010$ ($\pm .25$) unless otherwise specified
4. Ground pin positions are within $.015$ (0.38) dia. of true position
5. Ground pin head dia., 0.035 (0.89) ref: height 0.010 (0.25) ref.
6. Lead dia. 0.017 (0.43) nom.

APPENDIX: Teledyne Relays T²R Program

Teledyne Relays' **T²R** program was developed to provide the JAN relay user an alternate means of specifying and procuring established reliability relays. The form, fit and function of a **T²R** relay is the same as that of its JAN counterpart. **T²R** program requirements differ in certain regimens/tests found in both MIL-PRF-28776 and MIL-PRF-39016 that add cost but no value to the relay.

This program parallels the military specifications in most aspects. The components that make up such a program are intricate and varied. Furthermore, there are additional options of high value for design, manufacturability and operation of high reliability assemblies. The following page presents a table that compares the 100% screening performed on JAN relays and **T²R** relays prior to shipment.

Other significant highlights of the **T²R** program include:

- Two unique screening levels
- The ability to define lead finish
- Spacer pad options which may not be available in military specifications
- Ground pin options which may not be available in military specifications
- Reduced lead time
- Reduced cost

The program is fully defined for both general product requirements and detailed product requirements in the following Teledyne Relays specifications:

TR-R-1
TR-STD-1
TR-STD-2
TR-ERL-1
TR-R-1/XXX
TR Supplement

Copies of these documents are available from Teledyne Relays. We suggest that users check with Teledyne Relays from time to time to assure that they have the latest issue.

Can't Find What You Need?

Check out our full line of relays and switches. Order literature online at <http://www.teledynere relays.com/lit-request.asp>

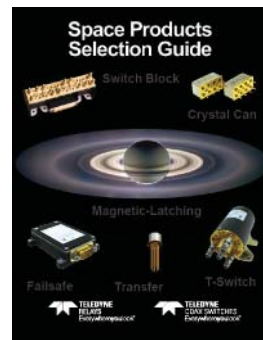
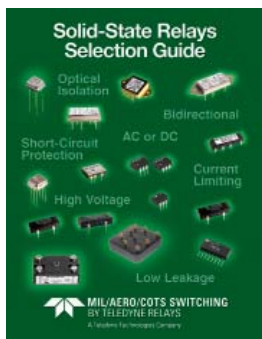

APPENDIX: Teledyne Relays T²R Program

INSPECTION	Screening Levels			
	<i>T²R</i> A Level 1.5%/10K Cycles	<i>T²R</i> B Level .75%/10K Cycles	JAN L Level 3%/10K Cycles	JAN M Level 1%/10K Cycles
Subgroup 1				
Screening, Internal Moisture AQL ¹	✓	✓	✓	✓
Vibration (Sinusoidal) AQL ¹			✓	
Vibration (Sinusoidal) 100%		✓		✓
Screening, Burn-In (Hybrids only)			✓	✓
Screening, Run-In (Room Temperature)	✓			
Screening, Run-In (+125°C and -65°C)		✓	✓	✓
Subgroup 2				
Coil Resistance or Coil Current	✓	✓	✓	✓
Insulation Resistance	✓	✓	✓	✓
Dielectric Withstanding Voltage	✓	✓	✓	✓
Static Contact Resistance	✓	✓	✓	✓
Pickup and Dropout or Set and Reset Voltage	✓	✓	✓	✓
Operate and Release or Set and Reset Time	✓	✓	✓	✓
Hold Voltage			✓	✓
Turn-On and Turn-Off Time (Hybrids only)	✓	✓	✓	✓
Contact Bounce Time	✓		✓	
Contact Stabilization Time		✓		✓
Turn-On Current (T Hybrids only)	✓	✓	✓	✓
Turn-On Voltage (C Hybrids only)	✓	✓	✓	✓
Turn-Off Voltage (Hybrids only)	✓	✓	✓	✓
Coil Transient Suppression (D, DD and Hybrids only)	✓	✓	✓	✓
Diode Blocking Integrity (DD only)	✓	✓	✓	✓
Zener Voltage (C Hybrid only)	✓	✓	✓	✓
Neutral Screen (Latching Relays only)	✓	✓	✓	✓
Break Before Make Verification			✓	✓
Contact Simultaneity			✓	✓
Subgroup 3				
Solderability 2 Samples per Daily Solderability Inspection Lot	✓	✓	✓	✓
Leak Test	✓	✓	✓	✓
External Visual and Mechanical Inspection 2/Lot for Dimension and Weight Check	✓	✓	✓	✓

¹ AQL = Acceptable Quality Level

Teledyne Relays: Because in deep space there is no acceptable failure rate

Teledyne Relays has a long history of supplying High Reliability relays for use in space bound vehicles. From the earliest deep space probes, such as Voyager I, now nearing 21 billion miles out in space, to the next generation of probes scheduled for the future, Teledyne Relays continues to be the preeminent supplier of Hi-Reliability relays to the space market.

Teledyne Relays Hi-Reliability Specification: TR-HIREL-1

- Eliminates the need for customers to develop and maintain specifications.
- Manufacturing and Quality Assurance requirements are fully defined and documented.
- Meets the general requirements of both ESA/SCC and NASA/GSFC documents.
- Offers options for 100% Group A screening
- Offers options for 3 levels of Lot Acceptance Testing (LAT).

Teledyne Screening Document 0-40-837

NASA approved screening regimen based on NASA/GSFC S-311-P.754

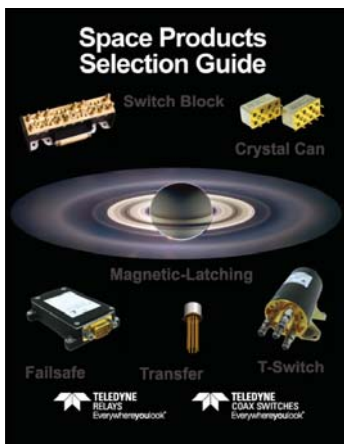

RELAY TYPES

- TO-5 Magnetic-Latching Relays
- TO-5 Non-Latching Relays
- TO-5 Magnetic-Latching, High-Shock Relays
- TO-5 Non-Latching, High-Shock Relays
- TO-5 Non-Latching, High-Vibration Relays

HI-REL SCREENING CAPABILITIES

- 100% Open Electrical Inspection
- 100% Precap Inspection
- Fully Automated Small Particle Inspection (Millipore Clean)
- Asynchronous Miss Test
- Coil Continuity
- Sine Vibration
- Random Vibration
- High/Low Run In (Miss Test) $-65^{\circ}\text{C} \pm 125^{\circ}\text{C}$
- Radiographic Inspection
- Mechanical Shock Test
- Thermal Shock Test
- Acceleration
- Radiographic Inspection (X-ray)
- Mechanical Shock Test
- Thermal Shock Test
- Acceleration
- Load Banks for a Variety of Life Test Load
- Serialized Printed Electrical Data
- Continuous Life Testing
- Environmental Testing
- Vertical Integration

For information or answers to your questions, please visit our website.

Description

The InP1012 Series is a highly compact, reflective SPDT Active RF switch, manufactured using Teledyne's high speed, low-loss InP HEMT process. The switch die is packaged in a low-loss, surface mount package, with a small form factor: 3mm(L) x 3mm(W) x 1mm(H). It supports a wide frequency range from DC to 60GHz, and delivers low insertion loss, fast switching time, and good isolation-making this switch ideal for test and measurement, microwave communications, and radar applications. The unique construction features and manufacturing techniques provide excellent robustness to environmental extremes and overall high reliability

Features

- High digital bandwidth, greater than 40Gbps
- Very high linearity
- Low insertion loss
- Very fast switching time of less than 100ns
- Radiation tolerant up to 100 krad

Frequency Range	DC -60GHz
Bit Rate	40+ Gbps
Operate Time	60-100ns
Enclosure	Low-Loss Surface Mount Package
Dimensions	3mm (L) x 3mm (W) x 1mm (H)
Temperature	Storage: -65°C to +125°C Operating: -65°C to +125°C

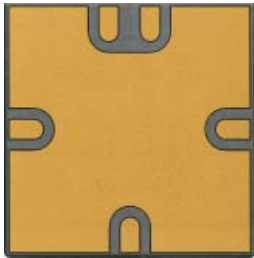
Part No.	Typical RF Performance			
	Frequency	Insertion Loss (dB)	Isolation (dB)	Return Loss (dB)
 InP1012	DC (20mV-)	2.0	---	---
	10KHz	0.9	67	---
	100MHz	1.2	60	23
	6GHz	1.6	37	21
	14GHz	2.0	30	21
	20GHz	2.3	27	23
	30GHz	2.6	24	26
	40GHz	2.9	21	25
	50GHz	3.3	19	25
	60GHz	3.7	17	16

TYPICAL SIGNAL INTEGRITY CHARACTERISTICS @ 40 Gbps

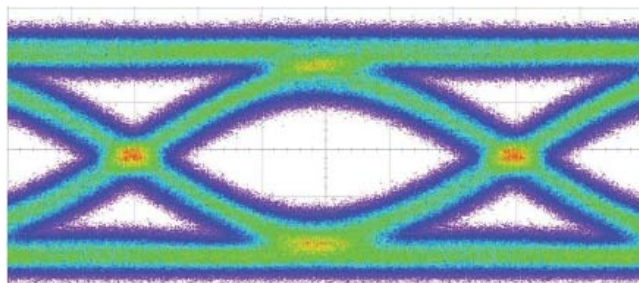

PATTERN GENERATOR SETTINGS

- 2³¹-1 PRBS signal
- 40Gbps data rate
- Data amplitude of 500mVpp

OUTLINE DIMENSIONS

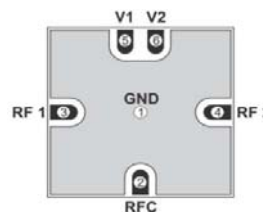
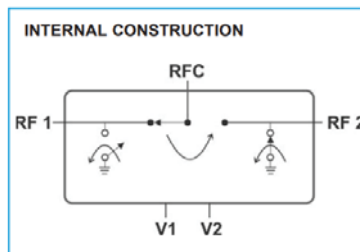
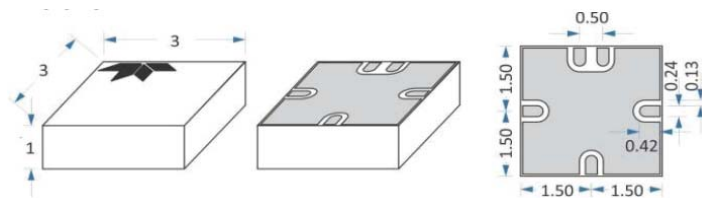

Did you know...

Teledyne Coax Switches offers coaxial switches for ATE, Radar, Amplifier Switching, Etc.?

SPDT SWITCHES

- DC - 40GHz, Internal 50Ω Termination
- SMA, mini-SMB, TNC & N Connectors
- 5 Million Cycles
- High Power & Low PIM
- Failsafe & Latching



TRANSFER SWITCHES

- DC - 18GHz
- SMA, TNC & N Connectors
- 5 Million Cycles
- High Power
- Failsafe & Latching



MULTI-THROW SWITCHES

- DC - 40 GHz, Internal 50Ω Termination
- SMA, mini-SMB, TNC & N Connectors
- SP3T - SP10T
- 5 Million Cycles
- Normally Open & Latching



LOW PIM SWITCHES

- DC - 3 GHz
- SMA, N and 7/16 D Connectors
- SPDT, Transfer and Multi-Throw
- Failsafe & Latching



SPECIALTY SWITCHES

- DC - 40GHz
- 3-State Attenuated Switch
- Radiation Shielding
- Switch Blocks
- Redundant Diode Configuration



Teledyne Relays offers Commercial/Industrial Solid State Relays?

SINGLE PHASE AC SOLID STATE RELAYS

- Up to 690Vac, 125A
- Input & Output Protection
- Chassis, DIN Rail and PCB Mount
- Zero-Cross & Random Switching
- Touch-Proof Covers



DUAL-PHASE AC SOLID STATE RELAYS

- Up to 600Vac, 50A
- Output Protection
- Chassis and DIN Rail
- Zero-Cross & Random Switching
- Touch-Proof Covers



3 & 4 PHASE SOLID STATE RELAYS

- Up to 600Vac, 75A
- Output Protection
- Chassis and DIN Rail
- Zero-Cross & Random Switching
- DC & AC Control

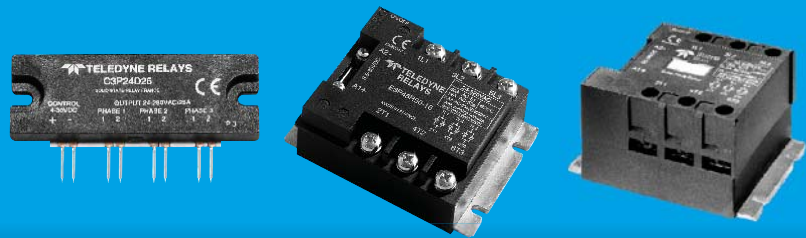

DC SOLID STATE RELAYS

- Up to 1400Vdc, 100A
- Output Protection
- Chassis, DIN Rail and PCB Mount
- IGBT and MOSFET
- Touch-Proof Covers



SOFT START MOTOR CONTROLLERS AND MOTOR REVERSERS

- Up to 26kW, 480Vac
- Star & Delta Configurations
- DIN Rail
- Output Protection
- Built-in Diagnostics and Self Test



Did you know...

Teledyne Relays offers Military Solid State Relays?

DC SOLID STATE RELAYS

- Meet MIL-PRF-28750
- Tested Per MIL-STD-704
- Silicon Carbide MOSFET
- Up to 250Vdc, 1A
- Chassis and PCB Mount
- Short-Circuit Protection
- Plastic and Hermetically Sealed



BI-DIRECTIONAL/AC SOLID STATE RELAYS

- Meet MIL-PRF-28750
- Tested Per MIL-STD-704
- Up to 250Vac, 25A
- Chassis and PCB Mount
- Short-Circuit Protection
- Plastic and Hermetically Sealed

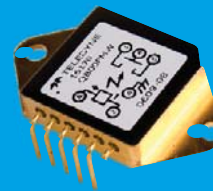

COMMERCIAL, LOW POWER, I/O MODULES

- Up to 250Vac, 10A
- Short-Circuit Protection
- Chassis and PCB Mount
- Zero-Cross & Random Switching
- Low Off-State Leakage Current



SILICON CARBIDE TECHNOLOGY

- Up to 270Vdc, 20 A
- Meet MIL-PRF-28750
- Tested Per MIL-STD-704
- Low ON resistance
- Low Profile Hermetic Package



Did you know...

Teledyne Coax Switches offers coaxial switch matrices for ATE, Radar, Filter Switching, Airborne Surveillance Systems, Etc.?

MINI MATRICES

- Remote Control via USB and/or Ethernet
- GUI controllable
- Accepts ASCII code
- Available in 18, 26.5 and 40 GHz
- SPDT, Transfer and Multi-throw configurations

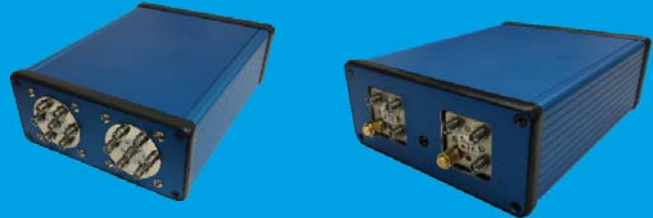

MULTIPLEXOR/FANOUT SWITCH MATRICES

- Up to 1x1024 Switch Matrix
- SMA, mini-SMB, TNC & N Connectors
- Failsafe, Latching or Normally Open Configurations
- Switching Systems for 50 Ω & 75 Ω applications

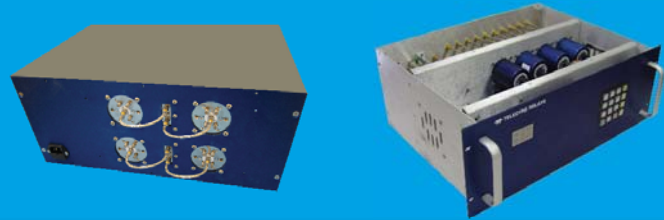

MIMO/BLOCKING AND MIMO SINGLE CONNECTION SWITCH MATRICES

- Up to 1x1024 Switch Matrix
- SMA, mini-SMB, TNC & N Connectors
- RS-232, TTL, USB, GPIB, TTL, Ethernet Control
- 1 Million Cycles
- Failsafe & Latching



CUSTOMIZED SWITCH MATRICES

- EMI/RFI
- Transient Suppression
- Ballistic Shock Fatigue
- Crash Load
- Altitude



Did you know...

Teledyne Relays offers Space Qualified Switches?

SPACE MARKET SEGMENTS SERVED

- *Deep-Space Probes*
- *Manned Programs*
- *Communications Satellites*
- *Launch Vehicles*
- *Earth Observatory / Weather Satellites*
- *Commercial / Military Satellites*



CAPABILITIES

- *Logistic Infrastructure*
- *Chemical Analysis Lab*
- *Scanning Electro Microscope*
- *In-house Plating Shop*
- *Environment Test Lab*
- *Field Technical Support*



ELECTROMECHANICAL RELAY SPECIFICATIONS

- *MIL-PRF-39016*
- *MIL-PRF-28776*
- *NASA/GSFC S-311-P-754*
- *NASA EEE-INST-002*
- *ESA/SCC 3601 & 3602*



HEADQUARTERS
12525 Daphne Ave.
Hawthorne, CA 90250
Phone: (323) 777-0077 or (800) 284-7007
Fax: (323) 241-1287

EUROPE
9-13 Napier Road
Wardpark North
Cumbernauld G68 OEF
Scotland UK
Phone: +44 (0) 1236 453 124
Fax: +44 (0) 1236 780 651

E-mail: relays@teledyne.com
www.teledynerelays.com



TELEDYNE
RELAYS
Everywhereyoulook™