

Compact Outdoor SSPA

Available in L, S, C, X and Ku Bands

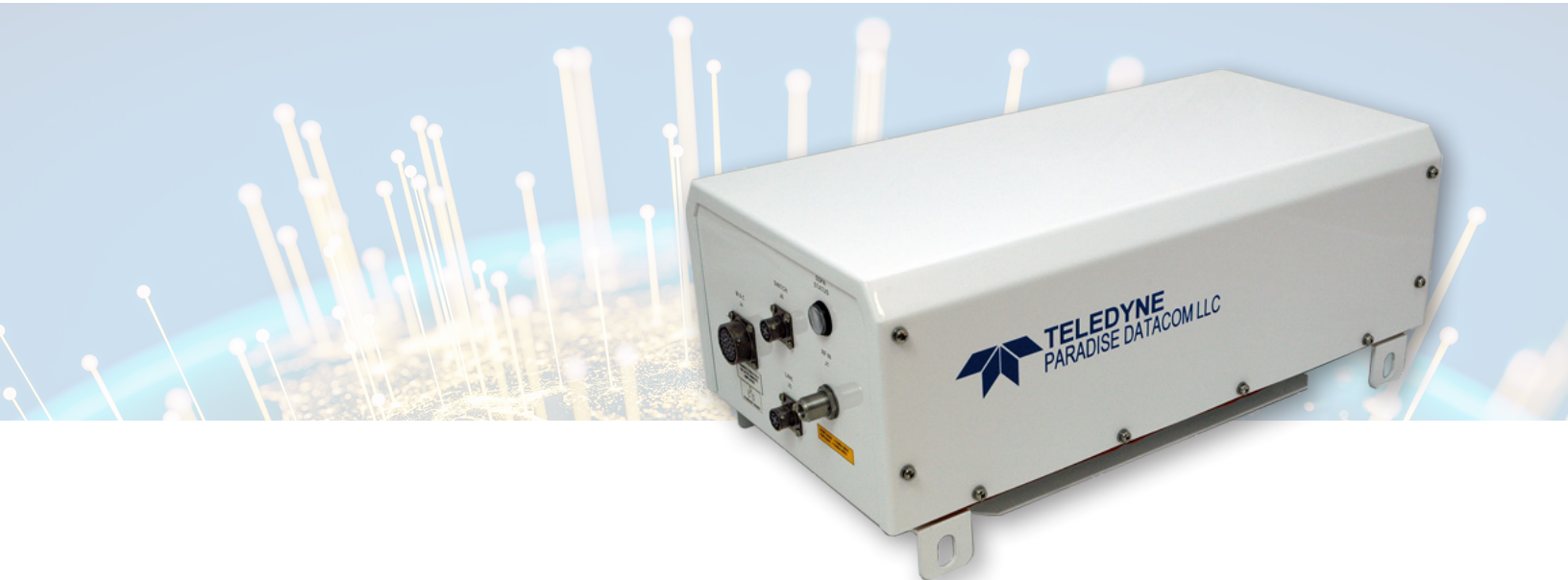

Superior Power Density
for Extreme Outdoor Environments

Field Proven in the World's Most Extreme Environments

The **Compact Outdoor** series of microwave amplifiers has been manufactured by Teledyne Paradise Datacom for more than 20 years and features a wide variety of frequency bands and output power levels, available in a common platform.



This platform has proven to be extremely robust and is fully qualified to MIL-STD- 810F environmental requirements. Each **Compact Outdoor SSPA** is factory tested over a wide temperature range, from -40 °C to +60 °C and is designed to withstand myriad issues that arise when designing equipment for hostile environments.

In 2010, Teledyne Paradise introduced GaN technology into their high power solid state amplifiers. Our engineers were at the forefront of the push to overcome the memory effect which was prevalent in the first generation of GaN devices. This coordination with the manufacturers continues, and has resulted in significant improvement in device performance industry-wide.

Hallmarks of the Compact Outdoor SSPA

- L band through Ku band
- GaAs & Gen II GaN
- Proprietary linearization techniques
- Compact size, weight, leading power density
- CE & MIL-STD 461
- Extreme Environmental Testing (MIL-STD-810F)

Available Output Powers (GaN and GaAs)

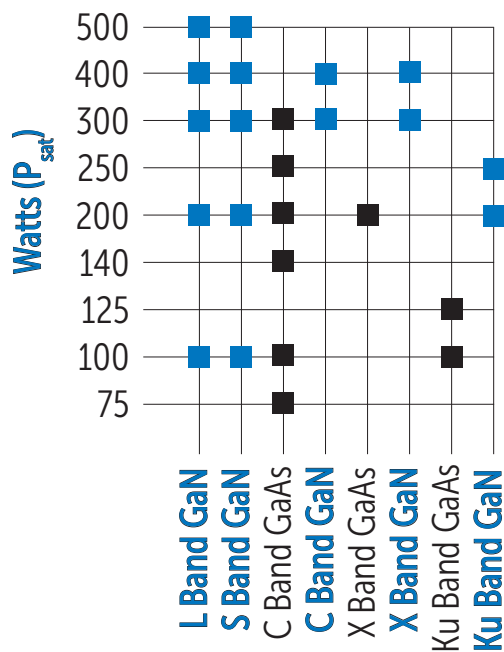

SSPA Technology Comparison

GaAs

- Lower Power Devices than GaN
- Better Linearity at low output power levels.
- Plinear = P1dB - 3 dB
- Gallium Arsenide based amplifiers are nearly Class A mode of operation

GaN

- Much higher power transistors.
- Same Linearity as GaAs at high output power levels (when linearized)
- Plinear = Psat - 3 dB {Linearized}
- Plinear = Psat - 4 dB {unLinearized}
- 2nd Generation GaN devices have solved the Memory Effect Limitation, allowing GaN amplifiers to reach their full potential as broadband multi-carrier Amplifiers for Satellite Communications
- Gallium Nitride based amplifiers are Class AB mode

General Specifications (typical)

Gain Adjustment	20 dB, 0.1 dB steps
Gain Flatness (full band)	± 1.0 dB
Gain Slope (per 40 MHz)	± 0.3 dB/40 MHz
Gain Variation vs. Temp. (-40 to +60 °C)	± 1.5 dB
Gain Stability (at constant temp.)	± 0.25 dB/24 hours
Intermod Distortion (2-tone, 5 MHz spacing) (@ Psat - 3 dB)	-25 dBc
AM/PM Conversion	< 1.0 °/dB
Spurious	-65 dBc
Harmonics	-50 dBc
Input VSWR	1.3:1
Output VSWR	1.3:1
Noise Figure (at maximum gain)	10 dB

See complete specifications on the [Outdoor SSPAs page](#) of the web site.

Compact Outdoor SSPA Features

- Compact Size: 10.0in x 19.5in. X 6.50in.
- Very light weight: as low as 36 lb. (16.4 kg.)
- Extremely Robust Outdoor Operation
- 40 °C to +60 °C Operating Range
- Universal Input Power Supply
- 90-265 VAC input range, PFC
- Variable Gain: 55 to 75 dB typical, 0.1 dB step adjustment
- True Power Reading Power Detector
- Output Power Sample Port, 40 dBc
- Internal 1:1 Redundant Controller
- Large status LED
- Serial or Parallel Monitor and Control (RS232/485)
- Ethernet Interface Standard, UDP, SNMP, Embedded Web Browser
- FSK Monitor and Control via IFL
- Auxiliary +15VDC power port for external equipment (LNB)
- Optional L Band Input with Integrated Block Up Converter
- Optional Receive Band Reject Filter (L/S- and X-bands only)
- Optional side-mount AC Input for SNG installations



Compact Outdoor I/O Connectors and Features

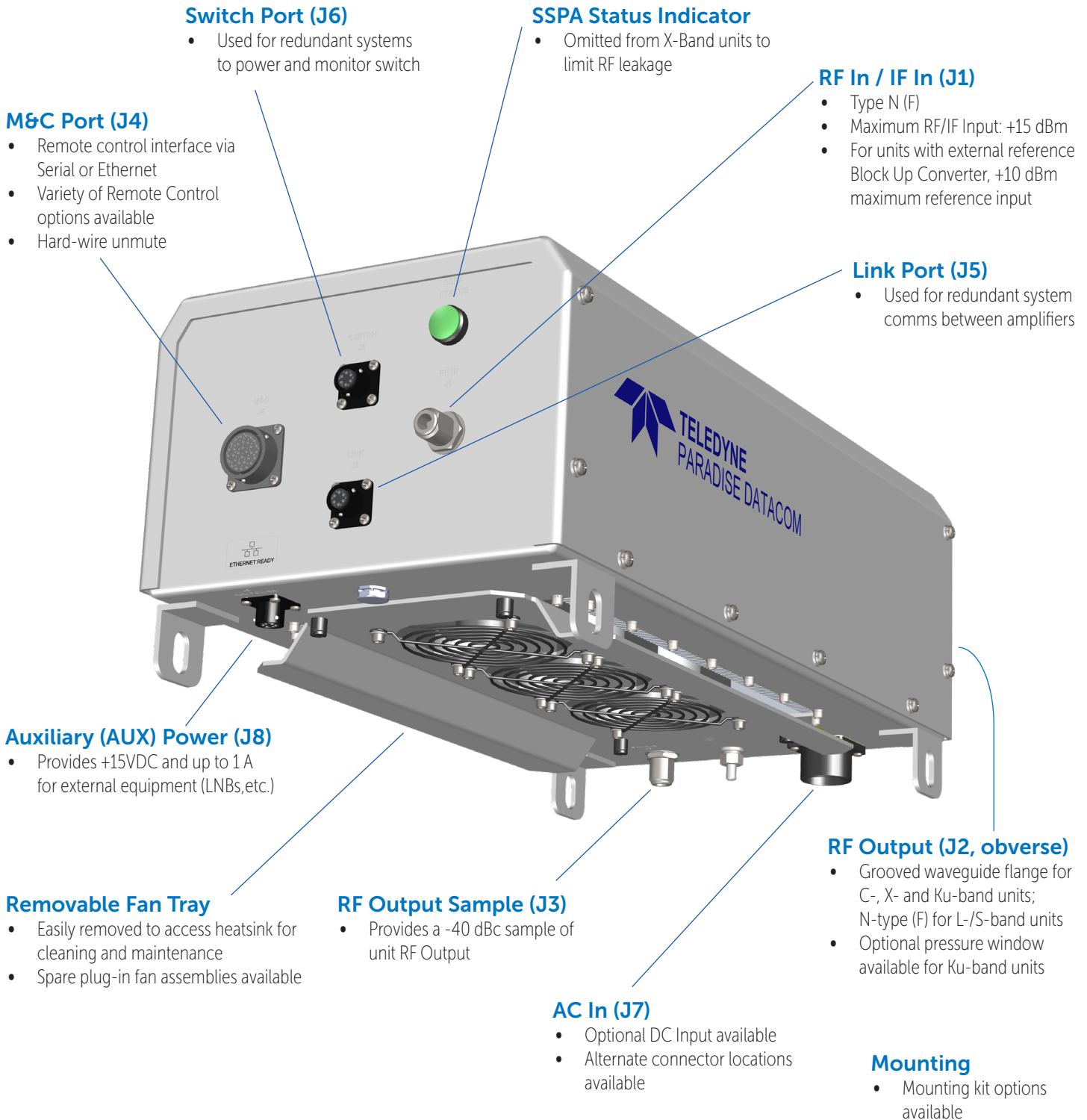

Variety of Remote Control Options

Embedded Web-based Control

The **Compact Outdoor SSPA**'s internal micro-controller contains an embedded web page from which the operator can perform all remote monitoring and control of the unit.

The multi-tab display offers status indicators, communication settings, and mute or attenuation control with a simple mouse click.

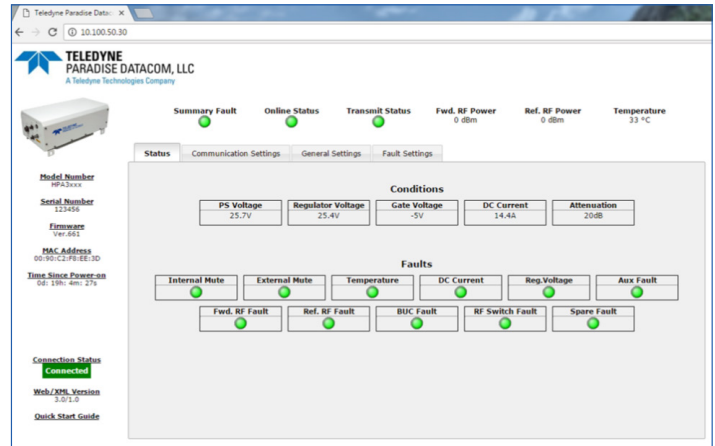

Embedded Web-based Monitor & Control: Connect to a PC running any modern web browser (Microsoft Edge, Chrome, Firefox).

Universal Monitor & Control Software

Alternately, connect the **Compact Outdoor SSPA** to a PC (directly or over a network) and install Teledyne Paradise Datacom's free Universal Monitor and Control software, available for download from the [web site](#).

Both the embedded web page and the Universal Monitor and Control Software are configurable for comms over RS-232/RS-485, IPNet, or SNMP.

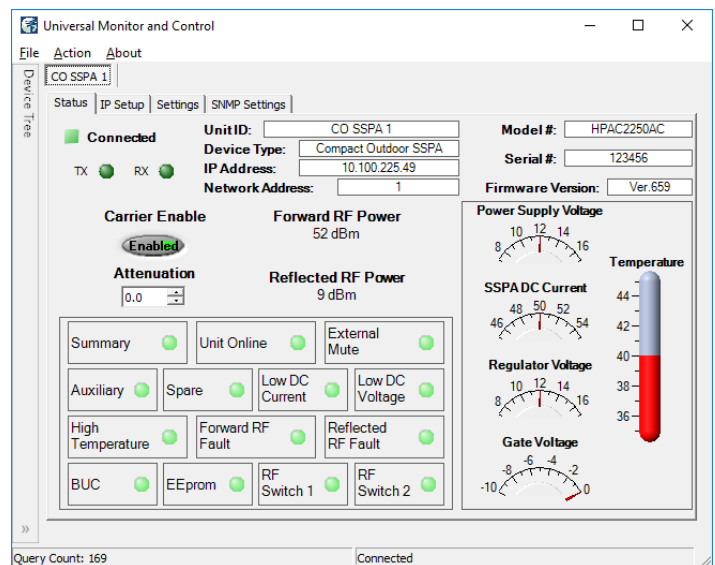

Teledyne Paradise Datacom Universal Monitor & Control Software: Download the free software from the company web site and run on any Windows-based PC.

RCH-1000 Hand-held Controller (Optional)

An optional hand-held controller is also available. The sealed enclosure provides an ingress protection level of IP65, which allows use in most outdoor environments. The rugged construction provides protection from impact and vibration.

The operator may adjust the attenuation of the connected unit, control the mute/unmute selection, and monitor the status, conditions and settings of the connected unit via a serial RS-485 connection.



RCH-1000 Hand-Held Controller: Works with both Compact Outdoor and High Power Outdoor SSPAs.

Compliance to Standards

Environmental Military Specs

MIL-STD-810F, Method 501.4: High Temperature
 MIL-STD-810F, Method 503.3: Temperature Shock
 MIL-STD-810F, Method 505.3: Solar Radiation
 MIL-STD-810F, Method 507.4: Damp Heat, Humidity
 MIL-STD-810F, Method 502.4: Low Temperature
 MIL-STD-810F, Method 506.4: Blowing Rain
 MIL-STD-810F, Method 510.3: Blowing Dust
 MIL-STD-810F, Method 510.3: Blowing Sand
 MIL-STD-810F, Method 508.5: Mold Growth
 MIL-STD-810F, Method 509.4: Salt Fog
 MIL-STD-344A: Random Vibration, 20 50Hz: 0.02 g
 2 Mz, then rolling up to 0.001g 2 /Hz at 500 Hz;
 Shock, 25g for 4000 bumps, 10g 6 msec, 12 bumps/s

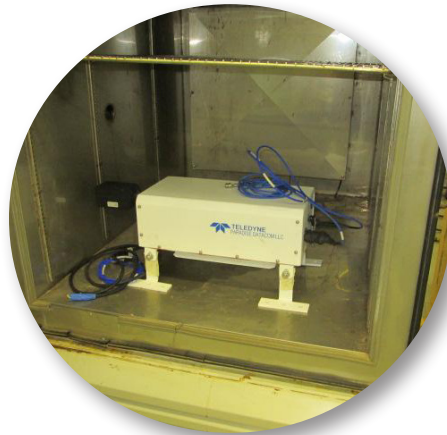

High Temperature
 60 °C to -40 °C, three cycles,
 2 hour dwell at each extreme

Commercial CE Compliance

EN 55022, 2007: Conducted Emissions
 EN 55022, 2007: Radiated Emissions
 EN 61000 3 2: 2001: Harmonic Current Emissions
 EN 61000 3 3: 1995: Voltage Fluctuations & Flicker
 EN 61000 4 2: 1999: Electrostatic Discharge
 EN 61000 4 3: Radiated Immunity
 EN 61000 4 4: 1995: Electrical Fast Transient / Burst
 EN 61000 4 5: 1995: Surge
 EN 61000 4 6: 2003: Conducted Immunity
 EN 61000 4 8: 1994: Magnetic Field Immunity
 EN 61000 4 11: 1994: Voltage Dips & Interruptions



Blowing Rain
 10 mm/hr at 40 MPH



Blowing Dust/Sand
 2kg/m³ of powder

EMI/EMC Military Specs

MIL-STD-461F, CE102: Conducted Emissions,
 Power Leads 10 kHz to 10 MHz
 MIL-STD-461F, CS101: Conducted Susceptibility,
 Power Leads, 30 Hz to 150 kHz
 MIL-STD-461F, CS114: Conducted Susceptibility,
 Bulk Cable Injection 10 kHz to 200 MHz
 MIL-STD-461F, CS115: Conducted Susceptibility,
 Bulk Cable Injection Impulse Excitation
 MIL-STD-461F, CS116: Conducted Susceptibility,
 Damped Sinusoidal Transients 10 kHz to 100 MHz
 MIL-STD-461F, RE102: Radiated Emissions, Electric
 Field 10 kHz to 18 GHz
 MIL-STD-461F, RE103: Radiated Susceptibility,
 Electric Field 30 MHz to 18 GHz
 MIL-STD-1686C, HESD: 16 kV, HESD level 3

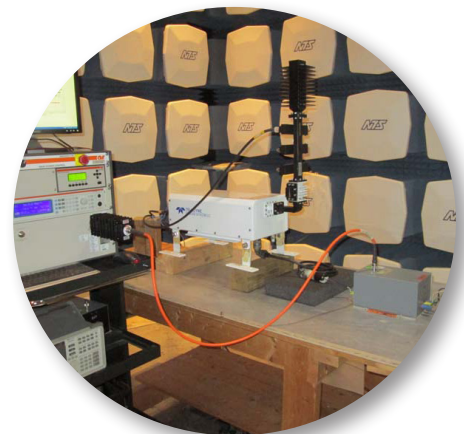

Conducted RF Immunity
 Signal applied:
 150kHz-80 MHz, 10Vrms
 1 kHz AM, 80% modulation



Magnetic Field Immunity
 30A/m, 50/60Hz

Quality Management Standards

ISO 9001:2015

System Configurations

Redundant Systems

Teledyne Paradise Datacom's **Compact Outdoor** series of redundant amplifier systems provide the highest degree of earth station redundancy and reliability. These systems can be configured in either 1:1 or 1:2 redundant configurations

The **Compact Outdoor SSPA** has a built-in 1:1 redundancy controller, allowing it to be used in 1:1 redundant systems without a separate external controller, although an optional controller is available. When used in a 1:2 redundant system a separate controller is required.

Phase Combined Systems

Phase combined systems provide a means to increase the RF output of a series of **Compact Outdoor** amplifiers by combining the output power with the use of a hybrid coupler or magic Tee.

These systems can be configured in either 1:1 or 1:2 phase combined configurations. 1:2 phase combined systems provide a spare amplifier which can be switched online should an online amplifier exhibit a fault. All phase combined systems require a separate controller.

PowerMAX Systems

Several **Compact Outdoor SSPAs** can be configured into a modular soft-fail redundant **PowerMAX** system, which acts as though it were a single amplifier. The **PowerMAX** system provides a high level of reliability and maintainability, while offering extremely high output power levels.

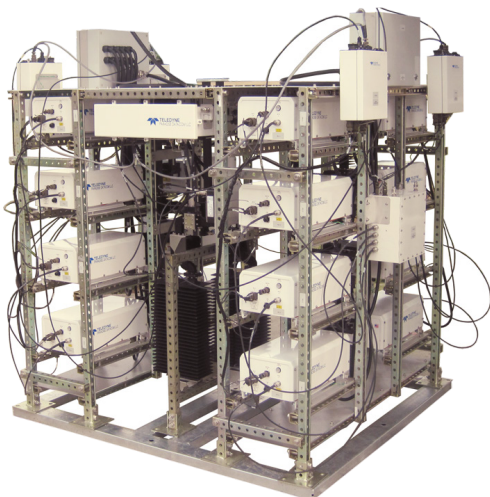

16-Module PowerMAX System with Compact Outdoor SSPAs

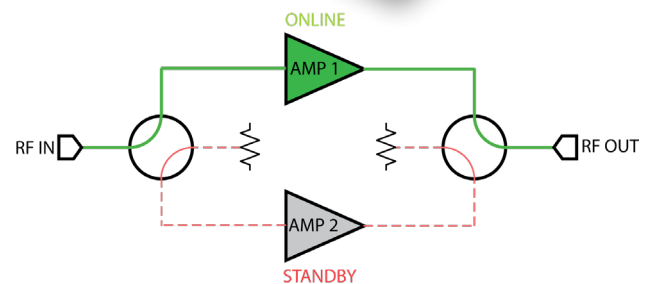
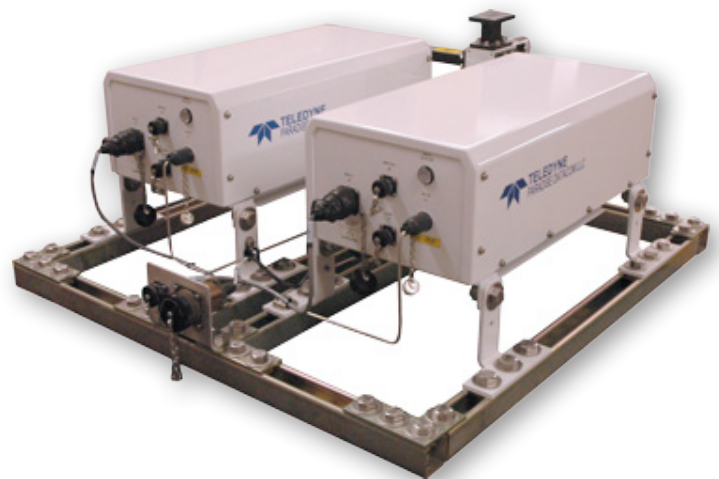

1:1 Redundant System Block Diagram with Amp 1 transmitting (online) and Amp 2 in reserve (standby).

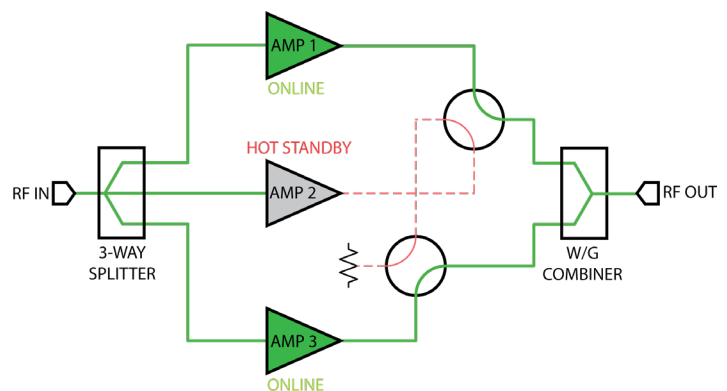
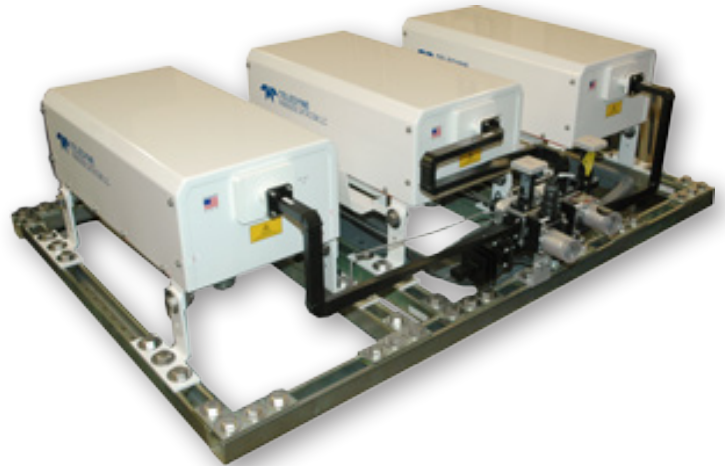

1:2 Phase Combined System Block Diagram with Amp 1 and Amp 3 transmitting (online) to a combined output, and Amp 2 in reserve (hot standby).

Global Sales Offices

U.S., Canada, Latin America
Teledyne Paradise Datacom
11361 Sunrise Park Drive
Rancho Cordova, CA 95742
Tel: +1 (814) 954-6163
sales@paradisedata.com

**Eastern Regional Sales Office
(Eastern U.S. & Latin America)**
RF Inquiries: John O'Grady, (848) 220-6464
Modem Inquiries: Mike Towner, (470) 509-9941
sales@paradisedata.com

**Western Regional Sales Office
(Western U.S. & Canada)**
Bruce Grieser
Cell: +1 (480) 444-9676
sales@paradisedata.com

U.K. Office
Europe, Middle East, Africa
Teledyne Paradise Datacom
106 Waterhouse Lane,
Chelmsford, Essex, England, CM1 2QU
Tel: +44(0)1245 847520
Tel: +44(0)1376 515636
sales@paradisedata.com

Asia Pacific
Tavechai Mektavepong
Teledyne Paradise Datacom Thailand Office
333, 20 C1 Fl., Lao Peng Nguan Tower 1,
Vibhavadi-Rangsit Rd.,
Chomphol, Chatuchak,
Bangkok 10900
Thailand

Tel: +66 2-272-2996
Fax: +66 2-272-2997
sales@paradisedata.com

Beijing, China
Teledyne Paradise Datacom Representative Office
Room 204, No.1 Building,
No.9 Jiuxianqiao East Road,
Chaoyang District,
Beijing, China 100016

Tel: +86 13601251528
sales@paradisedata.com

Teledyne Paradise Datacom reserves the right to change specifications of products described in this document at any time without notice and without obligation to notify any person of such changes.

Refer to the website or contact Sales or Customer Support for the latest product information. The product is classified EAR99 and is subject to U.S. Department of Commerce export control. Export re-export or diversion contrary to U.S. law is prohibited.