

54F/74F240•54F/74F241•54F/74F244

Octal Buffers/Line Drivers with TRI-STATE® Outputs

General Description

The 'F240, 'F241 and 'F244 are octal buffers and line drivers designed to be employed as memory and address drivers, clock drivers and bus-oriented transmitters/receivers which provide improved PC and board density.

Features

- TRI-STATE outputs drive bus lines or buffer memory address registers
- Outputs sink 64 mA (48 mA mil)
- 12 mA source current
- Input clamp diodes limit high-speed termination effects
- Guaranteed 4000V minimum ESD protection

Ordering Code: See Section 11

Commercial	Military	Package Number	Package Description
74F240PC		N20A	20-Lead (0.300" Wide) Molded Dual-In-Line
	54F240DM (Note 2)	J20A	20-Lead Ceramic Dual-In-Line
74F240SC (Note 1)		M20B	20-Lead (0.300" Wide) Molded Small Outline, JEDEC
74F240SJ (Note 1)		M20D	20-Lead (0.300" Wide) Molded Small Outline, EIAJ
	54F240FM (Note 2)	W20A	20-Lead Cerpack
	54F240LM (Note 2)	E20A	20-Lead Ceramic Leadless Chip Carrier, Type C
74F241PC		N20A	20-Lead (0.300" Wide) Molded Dual-In-Line
	54F241DM (Note 2)	J20A	20-Lead Ceramic Dual-In-Line
74F241SC (Note 1)		M20B	20-Lead (0.300" Wide) Molded Small Outline, JEDEC
74F241SJ (Note 1)		M20D	20-Lead (0.300" Wide) Molded Small Outline, EIAJ
	54F241FM (Note 2)	W20A	20-Lead Cerpack
	54F241LM (Note 2)	E20A	20-Lead Ceramic Leadless Chip Carrier, Type C
74F244PC		N20A	20-Lead (0.300" Wide) Molded Dual-In-Line
	54F244DM (Note 2)	J20A	20-Lead Ceramic Dual-In-Line
74F244SC (Note 1)		M20B	20-Lead (0.300" Wide) Molded Small Outline, JEDEC
74F244SJ (Note 1)		M20D	20-Lead (0.300" Wide) Molded Small Outline, EIAJ
74F244MSA (Note 1)		MSA20	20-Lead Molded Shrink Small Outline, EIAJ Type II
	54F244FM (Note 2)	W20A	20-Lead Cerpack
	54F244LM (Note 2)	E20A	20-Lead Ceramic Leadless Chip Carrier, Type C

Note 1: Devices also available in 13" reel. Use Suffix = SCX, SJX and MSAX.

Note 2: Military grade device with environmental and burn-in processing. Use suffix = DMOB, FMQB and LMQB.

Connection Diagrams

Pin Assignment for LCC

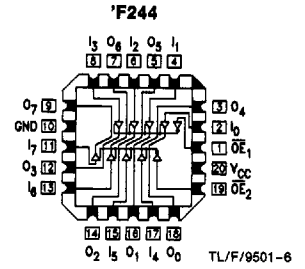
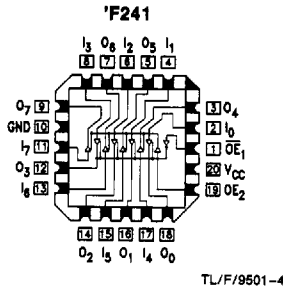
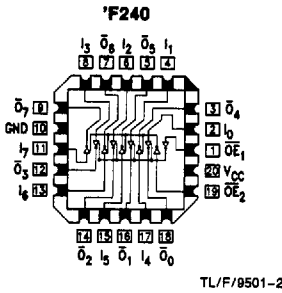

Pin Assignment for DIP, SOIC, SSOP and Flatpak

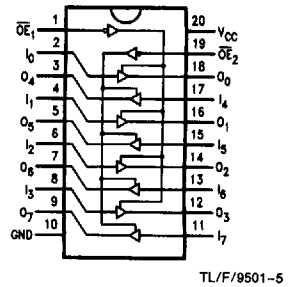
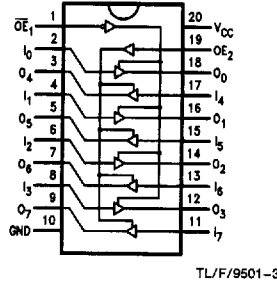
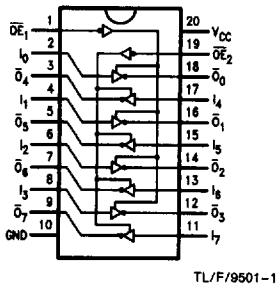

Logic Symbols

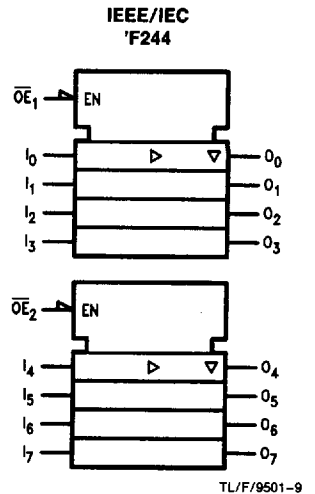
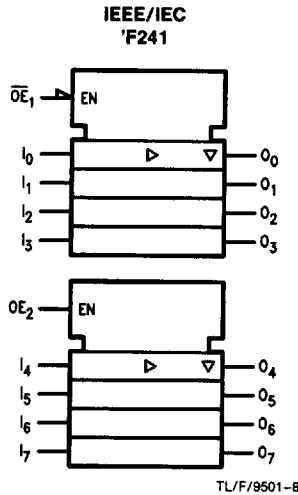
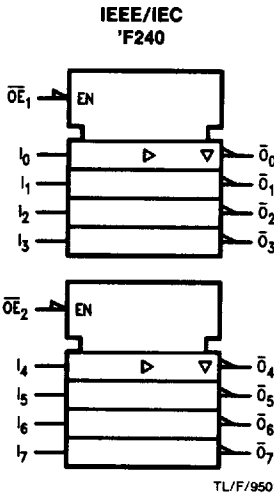

Unit Loading/Fan Out: See Section 2 for U.L. Definitions

Pin Names	Description	54F/74F	
		U.L. HIGH/LOW	Input I_{IH}/I_{IL} Output I_{OH}/I_{OL}
$\overline{OE}_1, \overline{OE}_2$	TRI-STATE Output Enable Input (Active LOW)	1.0/1.667	20 μ A/ -1 mA
OE_2	TRI-STATE Output Enable Input (Active HIGH)	1.0/1.667	20 μ A/ -1 mA
I_0-I_7	Inputs ('F240)	1.0/1.667*	20 μ A/ -1 mA
I_0-I_7	Inputs ('F241, 'F244)	1.0/2.667*	20 μ A/ -1.6 mA
$\overline{O}_0-\overline{O}_7, O_0-O_7$	Outputs	600/106.6 (80)	-12 mA/64 mA (48 mA)

*Worst-case 'F240 enabled; 'F241, 'F244 disabled

Truth Tables

'F240

\overline{OE}_1	D_{1n}	O_{1n}	\overline{OE}_2	D_{2n}	O_{2n}
H	X	Z	H	X	Z
L	H	L	L	H	L
L	L	H	L	L	H

'F244

\overline{OE}_1	D_{1n}	O_{1n}	\overline{OE}_2	D_{2n}	O_{2n}
H	X	Z	H	X	Z
L	H	H	L	H	H
L	L	L	L	L	L

H = HIGH Voltage Level

L = LOW Voltage Level

X = Immaterial

Z = High Impedance

'F241

\overline{OE}_1	D_{1n}	O_{1n}	OE_2	D_{2n}	O_{2n}
H	X	Z	L	X	Z
L	H	H	H	H	H
L	L	L	H	L	L

Absolute Maximum Ratings (Note 1)

If Military/Aerospace specified devices are required, please contact the National Semiconductor Sales Office/Distributors for availability and specifications.

Storage Temperature	-65°C to +150°C
Ambient Temperature under Bias	-55°C to +125°C
Junction Temperature under Bias	-55°C to +175°C
Plastic	-55°C to +150°C
V _{CC} Pin Potential to Ground Pin	-0.5V to +7.0V
Input Voltage (Note 2)	-0.5V to +7.0V
Input Current (Note 2)	-30 mA to +5.0 mA
Voltage Applied to Output in HIGH State (with V _{CC} = 0V)	
Standard Output	-0.5V to V _{CC}
TRI-STATE Output	-0.5V to +5.5V

Current Applied to Output in LOW State (Max) twice the rated I_{OL} (mA)

ESD Last Passing Voltage (Min) 4000V

Note 1: Absolute maximum ratings are values beyond which the device may be damaged or have its useful life impaired. Functional operation under these conditions is not implied.

Note 2: Either voltage limit or current limit is sufficient to protect inputs.

Recommended Operating Conditions

Free Air Ambient Temperature

Military	-55°C to +125°C
Commercial	0°C to +70°C

Supply Voltage

Military	+4.5V to +5.5V
Commercial	+4.5V to +5.5V

DC Electrical Characteristics

Symbol	Parameter		54F/74F			Units	V _{CC}	Conditions
			Min	Typ	Max			
V _{IH}	Input HIGH Voltage		2.0			V		Recognized as a HIGH Signal
V _{IL}	Input LOW Voltage					V		Recognized as a LOW Signal
V _{CD}	Input Clamp Diode Voltage					V	Min	I _{IN} = -18 mA
V _{OH}	Output HIGH Voltage	54F 10% V _{CC}	2.4			V	Min	I _{OH} = -3 mA I _{OH} = -12 mA I _{OH} = -3 mA I _{OH} = -15 mA I _{OH} = -3 mA
		54F 10% V _{CC}	2.0					
		74F 10% V _{CC}	2.4					
		74F 10% V _{CC}	2.0					
		74F 5% V _{CC}	2.7					
V _{OL}	Output LOW Voltage	54F 10% V _{CC}			0.55	V	Min	I _{OL} = 48 mA I _{OL} = 64 mA
		74F 10% V _{CC}			0.55			
I _{IH}	Input HIGH Current	54F			20.0	μA	Max	V _{IN} = 2.7V
		74F			5.0			
I _{BVI}	Input HIGH Current Breakdown Test	54F			100	μA	Max	V _{IN} = 7.0V
		74F			7.0			
I _{CEX}	Output HIGH Leakage Current	54F			250	μA	Max	V _{OUT} = V _{CC}
		74F			50			
V _{ID}	Input Leakage Test	74F	4.75			V	0.0	I _{ID} = 1.9 μA All Other Pins Grounded
I _{OD}	Output Leakage Circuit Current	74F			3.75	μA	0.0	V _{IOD} = 150 mV All Other Pins Grounded
I _{IL}	Input LOW Current			-1.0 -1.6		mA	Max	V _{IN} = 0.5V (OE ₁ , OE ₂ , OE ₂ , D _n ('F240)) V _{IN} = 0.5V (D _n ('F241, 'F244))
I _{OZH}	Output Leakage Current			50		μA	Max	V _{OUT} = 2.7V
I _{OZL}	Output Leakage Current			-50		μA	Max	V _{OUT} = 0.5V
I _{OS}	Output Short-Circuit Current			-100	-225	mA	Max	V _{OUT} = 0V
I _{ZZ}	Bus Drainage Test			500		μA	0.0V	V _{OUT} = 5.25V

DC Electrical Characteristics (Continued)

Symbol	Parameter	54F/74F			Units	V _{CC}	Conditions
		Min	Typ	Max			
I _{CC} H	Power Supply Current ('F240)		19	29	mA	Max	V _O = HIGH
I _{CC} L	Power Supply Current ('F240)		50	75	mA	Max	V _O = LOW
I _{CC} Z	Power Supply Current ('F240)		42	63	mA	Max	V _O = HIGH Z
I _{CC} H	Power Supply Current ('F241, 'F244)		40	60	mA	Max	V _O = HIGH
I _{CC} L	Power Supply Current ('F241, 'F244)		60	90	mA	Max	V _O = LOW
I _{CC} Z	Power Supply Current ('F241, 'F244)		60	90	mA	Max	V _O = HIGH Z

AC Electrical Characteristics: See Section 2 for Waveforms and Load Configurations

Symbol	Parameter	74F			54F		74F		Units	Fig. No.
		T _A = +25°C V _{CC} = +5.0V C _L = 50 pF			T _A , V _{CC} = Mil C _L = 50 pF		T _A , V _{CC} = Com C _L = 50 pF			
		Min	Typ	Max	Min	Max	Min	Max		
t _{PLH} t _{PHL}	Propagation Delay Data to Output ('F240)	3.0 2.0	5.1 3.5	7.0 4.7	3.0 2.0	9.0 6.0	3.0 2.0	8.0 5.7	ns	2-3
t _{PZH} t _{PZL}	Output Enable Time ('F240)	2.0 4.0	3.5 6.9	4.7 9.0	2.0 4.0	6.5 10.5	2.0 4.0	5.7 10.0	ns	2-5
t _{PHZ} t _{PLZ}	Output Disable Time ('F240)	2.0 2.0	4.0 6.0	5.3 8.0	2.0 2.0	6.5 12.5	2.0 2.0	6.3 9.5		
t _{PLH} t _{PHL}	Propagation Delay Data to Output ('F241, 'F244)	2.5 2.5	4.0 4.0	5.2 5.2	2.0 2.0	6.5 7.0	2.5 2.5	6.2 6.5	ns	2-3
t _{PZH} t _{PZL}	Output Enable Time ('F241, 'F244)	2.0 2.0	4.3 5.4	5.7 7.0	2.0 2.0	7.0 8.5	2.0 2.0	6.7 8.0	ns	2-5
t _{PHZ} t _{PLZ}	Output Disable Time ('F241, 'F244)	2.0 2.0	4.5 4.5	6.0 6.0	2.0 2.0	7.0 7.5	2.0 2.0	7.0 7.0		