

# 54AC280

## 9-Bit Parity Generator/Checker

### General Description

The 'AC280 is a high-speed parity generator/checker that accepts nine bits of input data and detects whether an even or an odd number of these inputs is HIGH. If an even number of inputs is HIGH, the Sum Even output is HIGH. If an odd number is HIGH, the Sum Even output is LOW. The Sum Odd output is the complement of the Sum Even output.

### Features

- $I_{CC}$  reduced by 50%
- 9-bit width for memory applications
- Standard Microcircuit Drawing (SMD) 5962-92201

### Logic Symbols

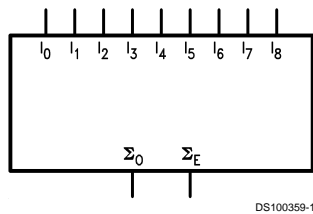

IEEE/IEC

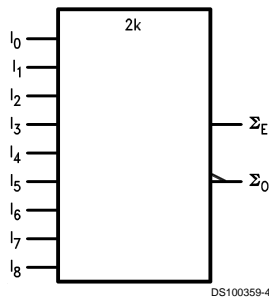

Pin Names	Description
$I_0-I_8$	Data Inputs
$\Sigma_O$	Odd Parity Output
$\Sigma_E$	Even Parity Output

### Connection Diagrams

Pin Assignment for DIP and Flatpak

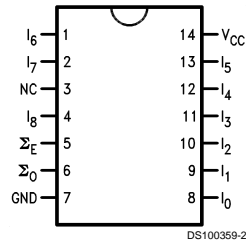

Pin Assignment for LCC

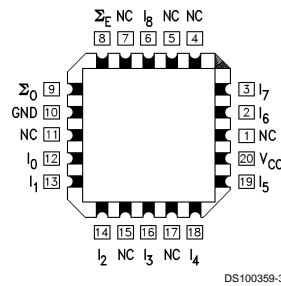

### Truth Table

Number of HIGH Inputs $I_0-I_8$	Outputs	
	$\Sigma$ Even	$\Sigma$ Odd
0, 2, 4, 6, 8	H	L
1, 3, 5, 7, 9	L	H

H = HIGH Voltage Level  
L = LOW Voltage Level

### Logic Diagram

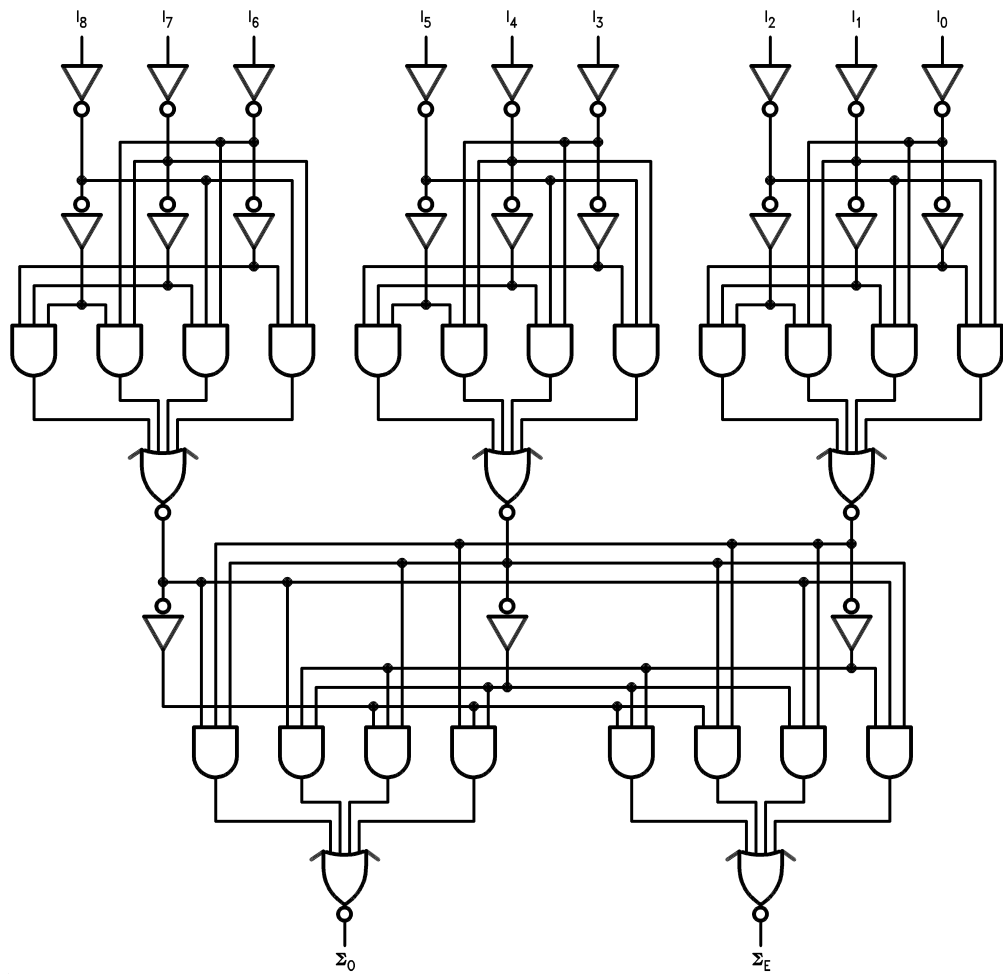

DS100359-5

Please note that this diagram is provided only for the understanding of logic operations and should not be used to estimate propagation delays.

## Absolute Maximum Ratings (Note 1)

If Military/Aerospace specified devices are required, please contact the National Semiconductor Sales Office/Distributors for availability and specifications.

Supply Voltage ( $V_{CC}$ )	-0.5V to +7.0V
DC Input Diode Current ( $I_{IK}$ )	
$V_I = -0.5V$	-20 mA
$V_I = V_{CC} + 0.5V$	+20 mA
DC Input Voltage ( $V_I$ )	-0.5V to $V_{CC} + 0.5V$
DC Output Diode Current ( $I_{OK}$ )	
$V_O = -0.5V$	-20 mA
$V_O = V_{CC} + 0.5V$	+20 mA
DC Output Voltage ( $V_O$ )	-0.5V to $V_{CC} + 0.5V$
DC Output Source or Sink Current ( $I_O$ )	±50 mA
DC $V_{CC}$ or Ground Current per Output Pin ( $I_{CC}$ or $I_{GND}$ )	±50 mA
Storage Temperature ( $T_{STG}$ )	-65°C to +150°C
Junction Temperature ( $T_J$ )	

CDIP

175°C

## Recommended Operating Conditions

Supply Voltage ( $V_{CC}$ )	'AC	2.0V to 6.0V
Input Voltage ( $V_I$ )		0V to $V_{CC}$
Output Voltage ( $V_O$ )		0V to $V_{CC}$
Operating Temperature ( $T_A$ )	54AC	-55°C to +125°C
Minimum Input Edge Rate ( $\Delta V/\Delta t$ )	'AC Devices	
	$V_{IN}$ from 30% to 70% of $V_{CC}$	
	$V_{CC}$ @ 3.3V, 4.5V, 5.5V	125 mV/ns

**Note 1:** Absolute maximum ratings are those values beyond which damage to the device may occur. The databook specifications should be met, without exception, to ensure that the system design is reliable over its power supply, temperature, output/input loading variables. National does not recommend operation of FACT circuits outside databook specifications.

## DC Characteristics for 'AC Family Devices

Symbol	Parameter	$V_{CC}$ (V)	54AC	Units	Conditions	
			$T_A =$ -55°C to +125°C			
			Guaranteed Limits			
$V_{IH}$	Minimum High Level Input Voltage	3.0	2.1	V	$V_{OUT} = 0.1V$ or $V_{CC} - 0.1V$	
		4.5	3.15			
		5.5	3.85			
$V_{IL}$	Maximum Low Level Input Voltage	3.0	0.9	V	$V_{OUT} = 0.1V$ or $V_{CC} - 0.1V$	
		4.5	1.35			
		5.5	1.65			
$V_{OH}$	Minimum High Level Output Voltage	3.0	2.9	V	$I_{OUT} = -50 \mu A$	
		4.5	4.4			
		5.5	5.4			
			3.0	2.4	V	(Note 2) $V_{IN} = V_{IL}$ or $V_{IH}$ $I_{OH} = -12 \text{ mA}$ $I_{OH} = -24 \text{ mA}$ $I_{OH} = -24 \text{ mA}$
			4.5	3.7		
			5.5	4.7		
$V_{OL}$	Maximum Low Level Output Voltage	3.0	0.1	V	$I_{OUT} = 50 \mu A$	
		4.5	0.1			
		5.5	0.1			
			3.0	0.50	V	(Note 2) $V_{IN} = V_{IL}$ or $V_{IH}$ $I_{OL} = 12 \text{ mA}$ $I_{OL} = 24 \text{ mA}$ $I_{OL} = 24 \text{ mA}$
			4.5	0.50		
			5.5	0.50		
$I_{IN}$	Maximum Input Leakage Current	5.5	±1.0	µA	$V_I = V_{CC}, GND$	
$I_{OLD}$	Minimum Dynamic Output Current (Note 3)	5.5	50	mA	$V_{OLD} = 1.65V \text{ Max}$	
$I_{OHD}$		5.5	-50	mA	$V_{OHD} = 3.85V \text{ Min}$	

## DC Characteristics for 'AC Family Devices (Continued)

Symbol	Parameter	V <sub>CC</sub> (V)	54AC		Units	Conditions
			T <sub>A</sub> = -55°C to +125°C			
			Guaranteed Limits			
I <sub>CC</sub>	Maximum Quiescent Supply Current	5.5	80.0		μA	V <sub>IN</sub> = V <sub>CC</sub> or GND

**Note 2:** All outputs loaded; thresholds on input associated with output under test.

**Note 3:** Maximum test duration 2.0 ms, one output loaded at a time.

**Note 4:** I<sub>IN</sub> and I<sub>CC</sub> @ 3.0V are guaranteed to be less than or equal to the respective limit @ 5.5V V<sub>CC</sub>.

## AC Electrical Characteristics

Symbol	Parameter	V <sub>CC</sub> (V) (Note 5)	54AC		Units
			T <sub>A</sub> = -55°C to +125°C C <sub>L</sub> = 50 pF		
			Min	Max	
t <sub>PLH</sub>	Propagation Delay	3.3	1.0	20.0	ns
t <sub>PHL</sub>	I <sub>n</sub> to Σ <sub>E</sub>	5.0	1.0	14.5	
t <sub>PLH</sub>	Propagation Delay	3.3	1.0	20.0	ns
t <sub>PHL</sub>	I <sub>n</sub> to Σ <sub>O</sub>	5.0	1.0	14.5	

**Note 5:** Voltage range 3.3 is 3.3V ±0.3V.

Voltage range 5.0 is 5.0V ±0.5V.

## Capacitance

Symbol	Parameter	Typ	Units	Conditions
C <sub>IN</sub>	Input Capacitance	4.5	pF	V <sub>CC</sub> = OPEN
C <sub>PD</sub>	Power Dissipation Capacitance	75.0	pF	V <sub>CC</sub> = 5.0V

**Physical Dimensions** inches (millimeters) unless otherwise noted

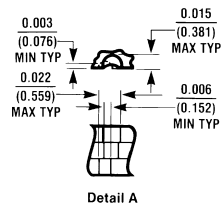
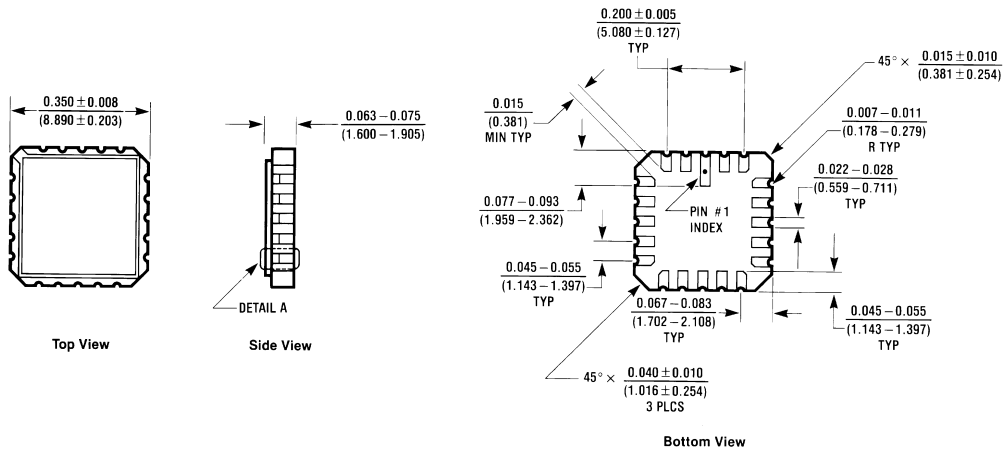

**20 Terminal Ceramic Leadless Chip Carrier**  
NS Package Number E20A

E20A (REV D)

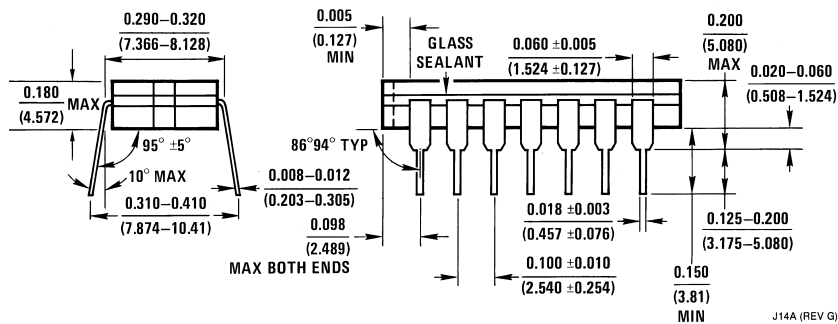
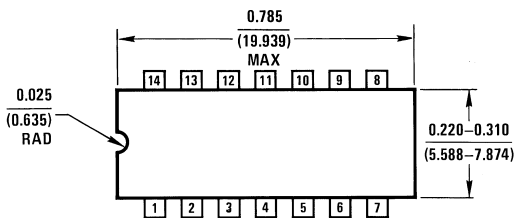

**14 Lead Ceramic Dual-In-Line Package**  
NS Package Number J14A

J14A (REV G)

**Physical Dimensions** inches (millimeters) unless otherwise noted (Continued)

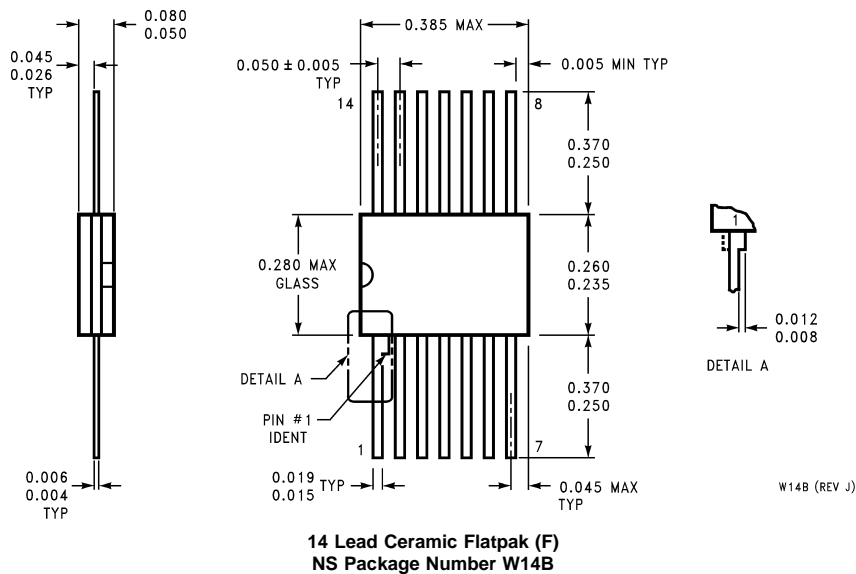

**LIFE SUPPORT POLICY**

NATIONAL'S PRODUCTS ARE NOT AUTHORIZED FOR USE AS CRITICAL COMPONENTS IN LIFE SUPPORT DEVICES OR SYSTEMS WITHOUT THE EXPRESS WRITTEN APPROVAL OF THE PRESIDENT OF NATIONAL SEMICONDUCTOR CORPORATION. As used herein:

1. Life support devices or systems are devices or systems which, (a) are intended for surgical implant into the body, or (b) support or sustain life, and whose failure to perform when properly used in accordance with instructions for use provided in the labeling, can be reasonably expected to result in a significant injury to the user.
2. A critical component in any component of a life support device or system whose failure to perform can be reasonably expected to cause the failure of the life support device or system, or to affect its safety or effectiveness.



**National Semiconductor Corporation**  
Americas  
Tel: 1-800-272-9959  
Fax: 1-800-737-7018  
Email: support@nsc.com

**National Semiconductor Europe**  
Fax: +49 (0) 1 80-530 85 86  
Email: europe.support@nsc.com  
Deutsch Tel: +49 (0) 1 80-530 85 85  
English Tel: +49 (0) 1 80-532 78 32  
Français Tel: +49 (0) 1 80-532 93 58  
Italiano Tel: +49 (0) 1 80-534 16 80

**National Semiconductor Asia Pacific Customer Response Group**  
Tel: 65-2544466  
Fax: 65-2504466  
Email: sea.support@nsc.com

**National Semiconductor Japan Ltd.**  
Tel: 81-3-5620-6175  
Fax: 81-3-5620-6179

www.national.com