

100363

Low Power Dual 8-Input Multiplexer

General Description

The 100363 is a dual 8-input multiplexer. The Data Select (S_n) inputs determine which bit (A_n and B_n) will be presented at the outputs (Z_a and Z_b , respectively). The same bit (0–7) will be selected for both the Z_a and Z_b output. All inputs have 50 k Ω pulldown resistors.

- 2000V ESD protection
- Pin/function compatible with 100163
- Voltage compensated operating range = $-4.2V$ to $-5.7V$
- Standard Microcircuit Drawing (SMD) 5962-9165501

Features

- 50% power reduction of the 100163

Logic Symbol

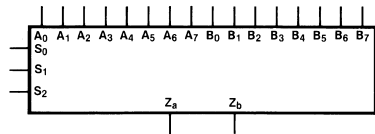

DS100310-1

Pin Names	Description
S_0 – S_2	Data Select Inputs
A_0 – A_7	A Data Inputs
B_0 – B_7	B Data Inputs
Z_a , Z_b	Data Outputs

Connection Diagrams

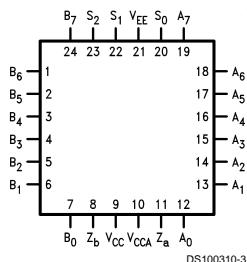
24-Pin Quad Cerpak

DS100310-3

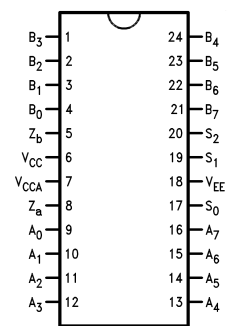
24-Pin DIP

DS100310-2

Logic Diagram

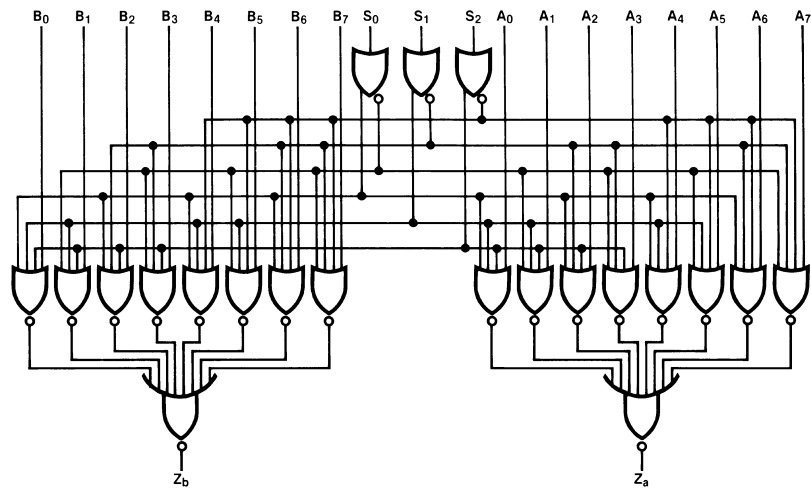

DS100310-5

Truth Table

Inputs											Outputs	
Select			Data								Z _a	Z _b
S ₂	S ₁	S ₀	A ₇ B ₇	A ₆ B ₆	A ₅ B ₅	A ₄ B ₄	A ₃ B ₃	A ₂ B ₂	A ₁ B ₁	A ₀ B ₀		
L	L	L								L	L	
L	L	L								H	H	
L	L	H							L		L	
L	L	H							H		H	
L	H	L						L			L	
L	H	L						H			H	
L	H	H					L				L	
L	H	H					H				H	
H	L	L				L					L	
H	L	L				H					H	
H	L	H			L						L	
H	L	H			H						H	
H	H	L		L							L	
H	H	L		H							H	
H	H	H	L								L	
H	H	H	H								H	

H = HIGH Voltage Level
 L = LOW Voltage Level
 Blank = X = Don't Care

Absolute Maximum Ratings (Note 1)

If Military/Aerospace specified devices are required, please contact the National Semiconductor Sales Office/Distributors for availability and specifications.

Above which the useful life may be impaired

Storage Temperature (T _{STG})	-65°C to +150°C
Maximum Junction Temperature (T _J)	
Ceramic	+175°C
V _{EE} Pin Potential to Ground Pin	-7.0V to +0.5V
Input Voltage (DC)	V _{EE} to +0.5V
Output Current (DC Output HIGH)	-50 mA

ESD (Note 2)

≥2000V

Recommended Operating Conditions

Case Temperature (T _C)	
Military	-55°C to +125°C
Supply Voltage (V _{EE})	-5.7V to -4.2V

Note 1: Absolute maximum ratings are those values beyond which the device may be damaged or have its useful life impaired. Functional operation under these conditions is not implied.

Note 2: ESD testing conforms to MIL-STD-883, Method 3015.

Military Version DC Electrical Characteristics

V_{EE} = -4.2V to -5.7V, V_{CC} = V_{CCA} = GND, T_C = -55°C to +125°C

Symbol	Parameter	Min	Max	Units	T _C	Conditions	Note	
V _{OH}	Output HIGH Voltage	-1025	-870	mV	0°C to +125°C	V _{IN} = V _{IH} (Max) or V _{IL} (Min)	Loading with 50Ω to -2.0V	(Notes 3, 4, 5)
		-1085	-870	mV	-55°C			
V _{OL}	Output LOW Voltage	-1830	-1620	mV	0°C to +125°C	V _{IN} = V _{IH} (Min) or V _{IL} (Max)	Loading with 50Ω to -2.0V	(Notes 3, 4, 5)
		-1830	-1555	mV	-55°C			
V _{OHC}	Output HIGH Voltage	-1035		mV	0°C to +125°C	V _{IN} = V _{IH} (Min) or V _{IL} (Max)	Loading with 50Ω to -2.0V	(Notes 3, 4, 5)
		-1085		mV	-55°C			
V _{OLC}	Output LOW Voltage		-1610	mV	0°C to +125°C	V _{IN} = V _{IH} (Min) or V _{IL} (Max)	Loading with 50Ω to -2.0V	(Notes 3, 4, 5)
			-1555	mV	-55°C			
V _{IH}	Input HIGH Voltage	-1165	-870	mV	-55°C to +125°C	Guaranteed HIGH Signal for All Inputs	(Notes 3, 4, 5, 6)	
V _{IL}	Input LOW Voltage	-1830	-1475	mV	-55°C to +125°C	Guaranteed LOW Signal for All Inputs	(Notes 3, 4, 5, 6)	
I _{IL}	Input LOW Current	0.50		μA	-55°C to +125°C	V _{EE} = -4.2V V _{IN} = V _{IL} (Min)	(Notes 3, 4, 5)	
I _{IH}	Input HIGH Current	S _n	265	μA	0°C to +125°C	V _{EE} = -5.7V V _{IN} = V _{IH} (Max)	(Notes 3, 4, 5)	
			A _n , B _n	340	μA			-55°C
		S _n	385	μA	-55°C			
			A _n , B _n	490	μA			-55°C
I _{EE}	Power Supply Current	-87	-30	mA	-55°C to +125°C	Inputs Open	(Notes 3, 4, 5)	

Note 3: F100K 300 Series cold temperature testing is performed by temperature soaking (to guarantee junction temperature equals -55°C), then testing immediately without allowing for the junction temperature to stabilize due to heat dissipation after power-up. This provides "cold start" specs which can be considered a worst case condition at cold temperatures.

Note 4: Screen tested 100% on each device at -55°C, +25°C, and +125°C, Subgroups 1, 2, 3, 7, and 8.

Note 5: Sample tested (Method 5005, Table I) on each manufactured lot at -55°C, +25°C, and +125°C, Subgroups A1, 2, 3, 7, and 8.

Note 6: Guaranteed by applying specified input condition and testing V_{OH}/V_{OL}.

AC Electrical Characteristics

$V_{EE} = -4.2V$ to $-5.7V$, $V_{CC} = V_{CCA} = GND$

Symbol	Parameter	$T_c = -55^\circ C$		$T_c = +25^\circ C$		$T_c = +125^\circ C$		Units	Conditions	Notes
		Min	Max	Min	Max	Min	Max			
t_{PLH}	Propagation Delay	0.50	2.40	0.60	2.30	0.70	3.00	ns	Figure 1 and Figure 2	(Notes 7, 8, 9)
t_{PHL}	A_0-A_7, B_0-B_7 to Output									
t_{PLH}	Propagation Delay	0.80	3.00	0.90	2.80	0.80	3.40	ns		
t_{PHL}	S_0-S_2 to Output									
t_{TLH}	Transition Time	0.30	1.90	0.30	1.80	0.30	2.10	ns		(Note 10)
t_{THL}	20% to 80%, 80% to 20%									

Note 7: F100K 300 Series cold temperature testing is performed by temperature soaking (to guarantee junction temperature equals $-55^\circ C$), then testing immediately after power-up. This provides "cold start" specs which can be considered a worst case condition at cold temperatures.

Note 8: Screen tested 100% on each device at $+25^\circ C$ temperature only, Subgroup A9.

Note 9: Sample tested (Method 5005, Table I) on each manufactured lot at $+25^\circ C$, Subgroup A9, and at $+125^\circ C$ and $-55^\circ C$, temperatures, Subgroups A10 and A11.

Note 10: Not tested at $+25^\circ C$, $+125^\circ C$, and $-55^\circ C$ temperature (design characterization data).

Test Circuitry

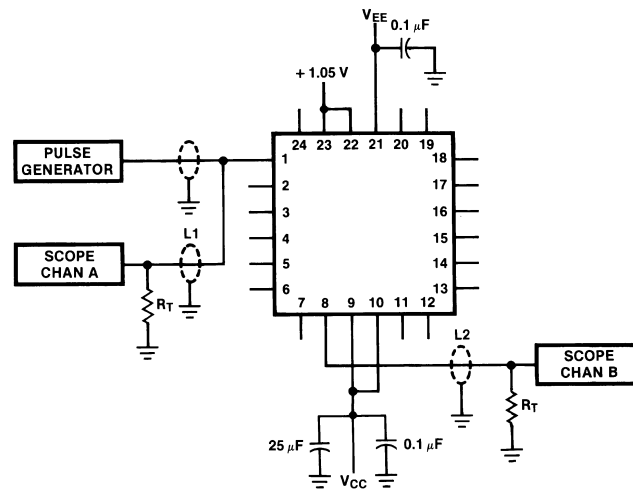

DS100310-6

Notes:

$V_{CC}, V_{CCA} = +2V$, $V_{EE} = -2.5V$

L1 and L2 = equal length 50Ω impedance lines

$R_T = 50\Omega$ terminator internal to scope

Decoupling 0.1 μF from GND to V_{CC} and V_{EE}

All unused outputs are loaded with 50Ω to GND

C_L = Fixture and stray capacitance ≤ 3 pF

Pin numbers shown are for flatpak; for DIP see logic symbol

FIGURE 1. AC Test Circuit

Switching Waveforms

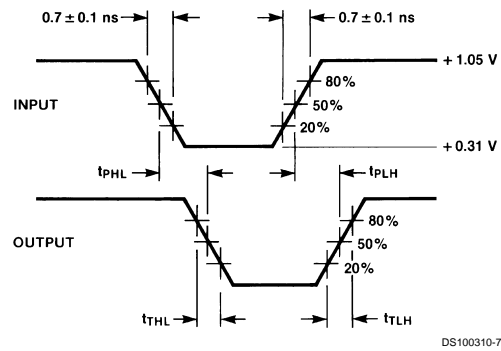
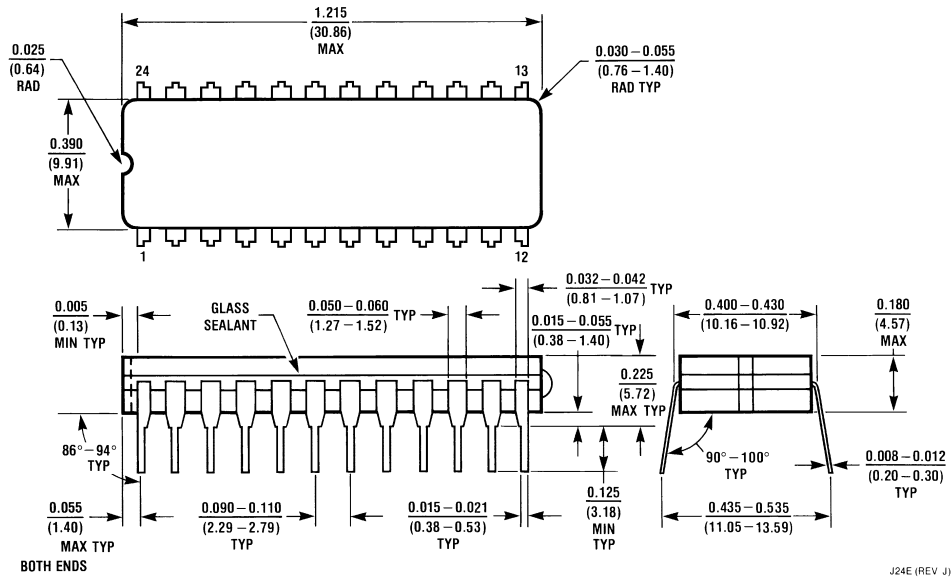

FIGURE 2. Propagation Delay and Transition Times

Physical Dimensions inches (millimeters) unless otherwise noted



J24E (REV J)

24-Pin Ceramic Dual-In-Line Package (D)
NS Package Number J24E

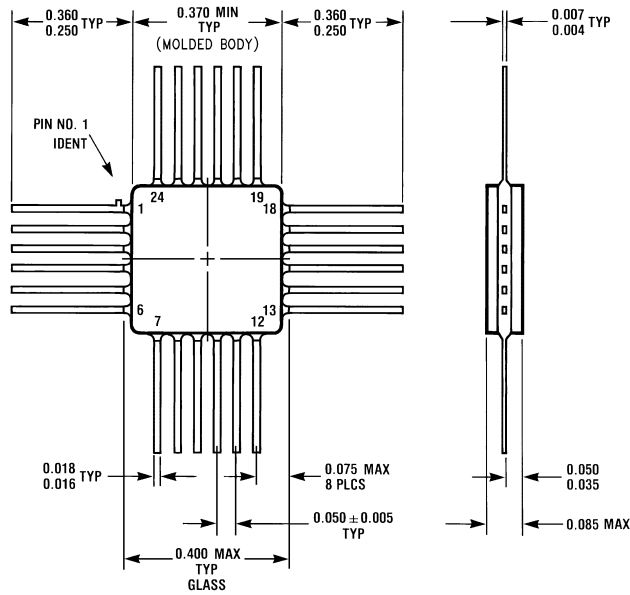

W24B (REV D)

24-Pin Quad Cerpak (F)
NS Package Number W24B

LIFE SUPPORT POLICY

NATIONAL'S PRODUCTS ARE NOT AUTHORIZED FOR USE AS CRITICAL COMPONENTS IN LIFE SUPPORT DEVICES OR SYSTEMS WITHOUT THE EXPRESS WRITTEN APPROVAL OF THE PRESIDENT OF NATIONAL SEMICONDUCTOR CORPORATION. As used herein:

1. Life support devices or systems are devices or systems which, (a) are intended for surgical implant into the body, or (b) support or sustain life, and whose failure to perform when properly used in accordance with instructions for use provided in the labeling, can be reasonably expected to result in a significant injury to the user.
2. A critical component in any component of a life support device or system whose failure to perform can be reasonably expected to cause the failure of the life support device or system, or to affect its safety or effectiveness.



National Semiconductor Corporation
Americas
Tel: 1-800-272-9959
Fax: 1-800-737-7018
Email: support@nsc.com

www.national.com

National Semiconductor Europe
Fax: +49 (0) 1 80-530 85 86
Email: europe.support@nsc.com
Deutsch Tel: +49 (0) 1 80-530 85 85
English Tel: +49 (0) 1 80-532 78 32
Français Tel: +49 (0) 1 80-532 93 58
Italiano Tel: +49 (0) 1 80-534 16 80

National Semiconductor Asia Pacific Customer Response Group
Tel: 65-2544466
Fax: 65-2504466
Email: sea.support@nsc.com

National Semiconductor Japan Ltd.
Tel: 81-3-5620-6175
Fax: 81-3-5620-6179