



**CY7C420, CY7C421, CY7C424
CY7C425, CY7C428, CY7C429**

Selection Guide

		7C420-20 7C421-20 7C424-20 7C425-20 7C428-20 7C429-20	7C420-25 7C421-25 7C424-25 7C425-25 7C428-25 7C429-25	7C420-30 7C421-30 7C424-30 7C425-30 7C428-30 7C429-30	7C420-40 7C421-40 7C424-40 7C425-40 7C428-40 7C429-40	7C420-65 7C421-65 7C424-65 7C425-65 7C428-65 7C429-65
Frequency (MHz)		33.3	28.5	25	20	12.5
Maximum Access Time (ns)		20	25	30	40	65
Maximum Operating Current (mA)	Commercial	142	132	125	115	100
	Military/Industrial		147	140	130	115

Maximum Rating

(Above which the useful life may be impaired. For user guidelines, not tested.)

- Storage Temperature - 65°C to +150°C
- Ambient Temperature with Power Applied - 55°C to +125°C
- Supply Voltage to Ground Potential - 0.5V to +7.0V
- DC Voltage Applied to Outputs in High Z State - 0.5V to +7.0V
- DC Input Voltage - 3.0V to +7.0V
- Power Dissipation 1.0W
- Output Current, into Outputs (LOW) 20 mA

Static Discharge Voltage >2001V
(per MIL-STD-883, Method 3015)

Latch-Up Current >200 mA

Operating Range

Range	Ambient Temperature ^[1]	V _{CC}
Commercial	0°C to + 70°C	5V ± 10%
Industrial	- 40°C to +85°C	5V ± 10%
Military	- 55°C to +125°C	5V ± 10%

Electrical Characteristics Over the Operating Range^[2]

Parameter	Description	Test Conditions	7C420-20 7C421-20 7C424-20 7C425-20 7C428-20 7C429-20		7C420-25 7C421-25 7C424-25 7C425-25 7C428-25 7C429-25		7C420-30 7C421-30 7C424-30 7C425-30 7C428-30 7C429-30		Unit	
			Min.	Max.	Min.	Max.	Min.	Max.		
V _{OH}	Output HIGH Voltage	V _{CC} = Min., I _{OH} = - 2.0 mA	2.4		2.4		2.4		V	
V _{OL}	Output LOW Voltage	V _{CC} = Min., I _{OL} = 8.0 mA		0.4		0.4		0.4	V	
V _{IH}	Input HIGH Voltage		Com ¹	2.0	V _{CC}	2.0	V _{CC}	2.0	V _{CC}	V
			Mil/Ind			2.2	V _{CC}	2.2	V _{CC}	
V _{IL}	Input LOW Voltage		-3.0	0.8	-3.0	0.8	-3.0	0.8	V	
I _{IX}	Input Leakage Current	GND ≤ V _I ≤ V _{CC}	- 10	+10	- 10	+10	- 10	+10	µA	
I _{OZ}	Output Leakage Current	R̄ ≥ V _{IH} , GND ≤ V _O ≤ V _{CC}	- 10	+10	- 10	+10	- 10	+10	µA	
I _{CC}	Operating Current	V _{CC} = Max., I _{OUT} = 0 mA	Com ¹ ^[3]		142		132		125	mA
			Mil/Ind ^[4]				147		140	
I _{SB1}	Standby Current	All Inputs = V _{IH} Min.	Com ¹		30		25		25	mA
			Mil/Ind				30		30	
I _{SB2}	Power-Down Current	All Inputs ≥ V _{CC} - 0.2V	Com ¹		25		20		20	mA
			Mil/Ind				25		25	
I _{OS}	Output Short Circuit Current ^[5]	V _{CC} = Max., V _{OUT} = GND		- 90		- 90		- 90	mA	

Notes:

1. T_A is the "instant on" case temperature.
2. See the last page of this specification for Group A subgroup testing information.
3. I_{CC} (commercial) = 100 mA + [(f̄ - 12.5) * 2 mA/MHz] for f̄ ≥ 12.5 MHz where f̄ = the larger of the write or read operating frequency.

4. I_{CC} (military) = 115 mA + [(f̄ - 12.5) * 2 mA/MHz] for f̄ ≥ 12.5 MHz where f̄ = the larger of the write or read operating frequency.
5. For test purposes, not more than one output at a time should be shorted. Short circuit test duration should not exceed 30 seconds.

5
FIFOS



**CY7C420, CY7C421, CY7C424
CY7C425, CY7C428, CY7C429**

Electrical Characteristics Over the Operating Range^[2] (continued)

Parameter	Description	Test Conditions	7C420-40 7C421-40 7C424-40 7C425-40 7C428-40 7C429-40		7C420-65 7C421-65 7C424-65 7C425-65 7C428-65 7C429-65		Unit	
			Min.	Max.	Min.	Max.		
V _{OH}	Output HIGH Voltage	V _{CC} = Min., I _{OH} = - 2.0 mA	2.4		2.4		V	
V _{OL}	Output LOW Voltage	V _{CC} = Min., I _{OL} = 8.0 mA		0.4		0.4	V	
V _{IH}	Input HIGH Voltage		Com'l	2.0	V _{CC}	2.0	V _{CC}	V
			Mil/Ind	2.2	V _{CC}	2.2	V _{CC}	
V _{IL}	Input LOW Voltage		- 3.0	0.8	- 3.0	0.8	V	
I _{IX}	Input Leakage Current	GND ≤ V _I ≤ V _{CC}	- 10	+10	- 10	+10	μA	
I _{OZ}	Output Leakage Current	$\bar{R} \geq V_{IH}, GND \leq V_O \leq V_{CC}$	- 10	+10	- 10	+10	μA	
I _{CC}	Operating Current	V _{CC} = Max., I _{OUT} = 0 mA	Com'l ^[3]		115		100	mA
			Mil/Ind ^[4]		130		115	
I _{SB1}	Standby Current	All Inputs = V _{IH} Min.	Com'l		25		25	mA
			Mil		30		30	
I _{SB2}	Power-Down Current	All Inputs ≥ V _{CC} - 0.2V	Com'l		20		20	mA
			Mil		25		25	
I _{OS}	Output Short Circuit Current ^[5]	V _{CC} = Max., V _{OUT} = GND		- 90		- 90	mA	

Capacitance^[6]

Parameter	Description	Test Conditions	Max.	Unit
C _{IN}	Input Capacitance	T _A = 25°C, f = 1 MHz, V _{CC} = 4.5V	8	pF
C _{OUT}	Output Capacitance		10	pF

Note:
6. Tested initially and after any design or process changes that may affect these parameters.

AC Test Loads and Waveforms

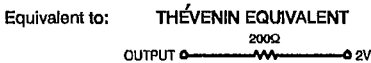
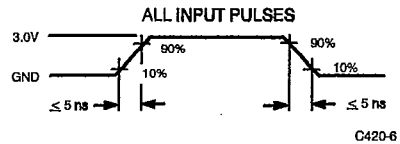
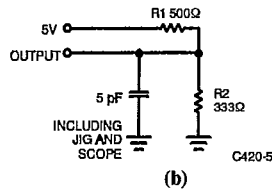
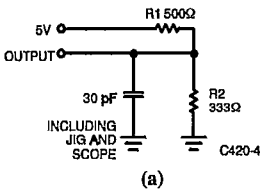

**CY7C420, CY7C421, CY7C424
CY7C425, CY7C428, CY7C429**
Switching Characteristics Over the Operating Range^[7, 8]

Parameter	Description	7C420-20		7C420-25		7C420-30		7C420-40		7C420-65		Unit
		Min.	Max.	Min.	Max.	Min.	Max.	Min.	Max.	Min.	Max.	
t _{RC}	Read Cycle Time	30		35		40		50		80		ns
t _A	Access Time		20		25		30		40		65	ns
t _{RR}	Read Recovery Time	10		10		10		10		15		ns
t _{PR}	Read Pulse Width	20		25		30		40		65		ns
t _{LZR} ^[9]	Read LOW to Low Z	3		3		3		3		3		ns
t _{DVR} ^[9,10]	Data Valid After Read HIGH	3		3		3		3		3		ns
t _{HZR} ^[9,10]	Read HIGH to High Z		15		18		20		25		30	ns
t _{WC}	Write Cycle Time	30		35		40		50		80		ns
t _{PW}	Write Pulse Width	20		25		30		40		65		ns
t _{HWZ} ^[9]	Write HIGH to Low Z	10		10		10		10		10		ns
t _{WR}	Write Recovery Time	10		10		10		10		15		ns
t _{SD}	Data Set-Up Time	12		15		18		20		30		ns
t _{HD}	Data Hold Time	0		0		0		0		10		ns
t _{MRS}	MR Cycle Time	30		35		40		50		80		ns
t _{PMR}	MR Pulse Width	20		25		30		40		65		ns
t _{RM}	MR Recovery Time	10		10		10		10		15		ns
t _{RPW}	Read HIGH to MR HIGH	20		25		30		40		65		ns
t _{WPW}	Write HIGH to MR HIGH	20		25		30		40		65		ns
t _{RTC}	Retransmit Cycle Time	30		35		40		50		80		ns
t _{PRT}	Retransmit Pulse Width	20		25		30		40		65		ns
t _{RTR}	Retransmit Recovery Time	10		10		10		10		15		ns
t _{EFL}	MR to EF LOW		30		35		40		50		80	ns
t _{HFH}	MR to HF HIGH		30		35		40		50		80	ns
t _{FFH}	MR to FF HIGH		30		35		40		50		80	ns
t _{REF}	Read LOW to EF LOW		25		25		30		35		60	ns
t _{RFF}	Read HIGH to FF HIGH		25		25		30		35		60	ns
t _{WEF}	Write HIGH to EF HIGH		25		25		30		35		60	ns
t _{WFF}	Write LOW to FF LOW		25		25		30		35		60	ns
t _{WHF}	Write LOW to HF LOW		30		35		40		50		80	ns
t _{RHF}	Read HIGH to HF HIGH		30		35		40		50		80	ns
t _{RAE}	Effective Read from Write HIGH		20		25		30		35		60	ns
t _{RPE}	Effective Read Pulse Width After EF HIGH	20		25		30		40		65		ns
t _{WAF}	Effective Write from Read HIGH		20		25		30		35		60	ns
t _{WPF}	Effective Write Pulse Width After FF HIGH	20		25		30		40		65		ns
t _{XOL}	Expansion Out LOW Delay from Clock		20		25		30		40		65	ns
t _{XOH}	Expansion Out HIGH Delay from Clock		20		25		30		40		65	ns



CY7C420, CY7C421, CY7C424
CY7C425, CY7C428, CY7C429

Switching Waveforms

Asynchronous Read and Write

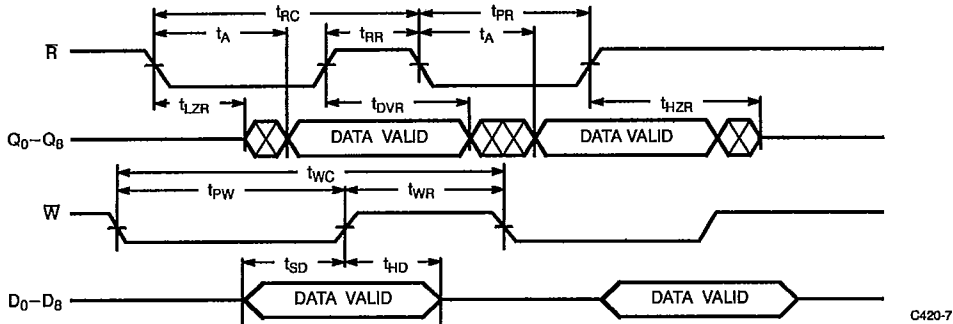

C420-7

Master Reset

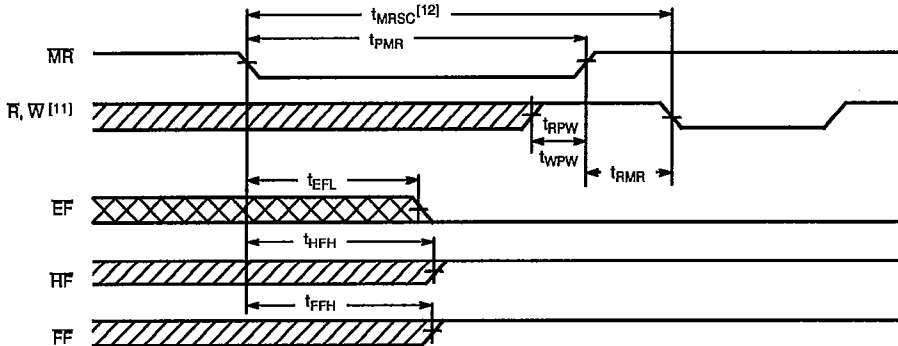

C420-8

Half-Full Flag

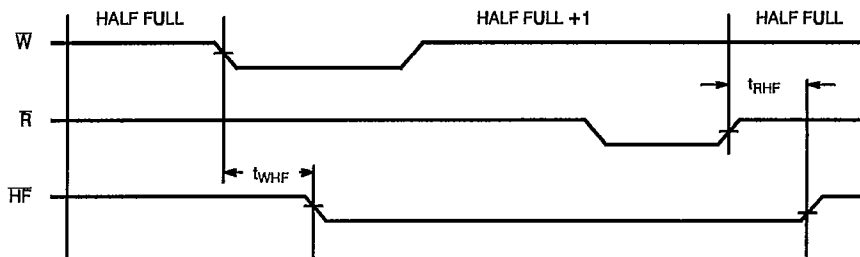

C420-9

Notes:

7. Test conditions assume signal transition time of 5 ns or less, timing reference levels of 1.5V and output loading of the specified I_{OL}/I_{OH} and 30 pF load capacitance, as in part (a) of AC Test Load and Waveforms, unless otherwise specified.
8. See the last page of this specification for Group A subgroup testing information.
9. t_{HZR} transition is measured at +500 mV from V_{OL} and -500 mV from V_{OH} . t_{DVR} transition is measured at the 1.5V level. t_{HWZ} and t_{LZR} transition is measured at ± 100 mV from the steady state.
10. t_{HZR} and t_{DVR} use capacitance loading as in part (b) of AC Test Load and Waveforms.
11. W and $R \geq V_{IH}$ around the rising edge of MR .
12. $t_{MRSC} = t_{PMR} + t_{RMR}$.



CY7C420, CY7C421, CY7C424
CY7C425, CY7C428, CY7C429

Switching Waveforms (continued)

Last Write to First Read Full Flag

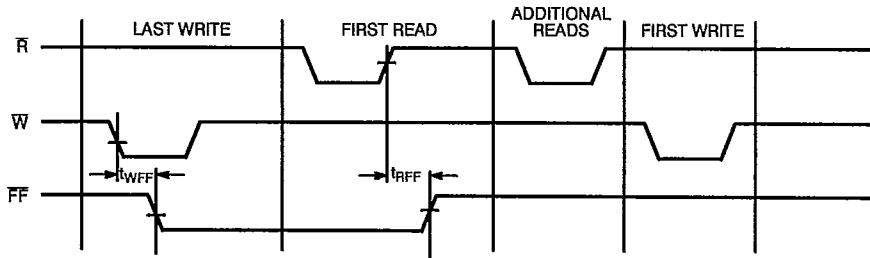

C420-10

Last Read to First Write Empty Flag

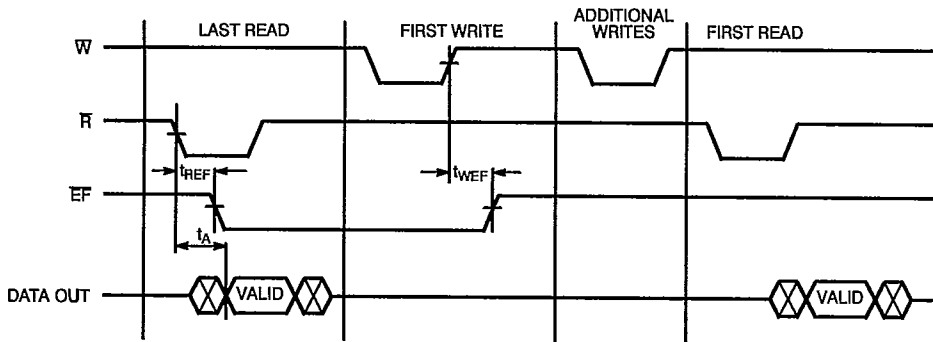

C420-11

Retransmit^[13]

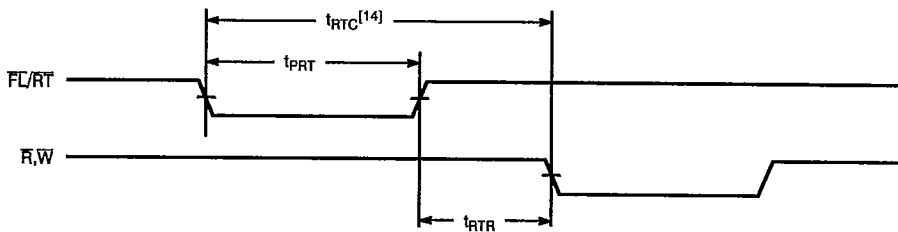

C420-12

Notes:

- 13. EF, HF and FF may change state during retransmit as a result of the offset of the read and write pointers, but flags will be valid at t_{RTC} .
- 14. $t_{RTC} = t_{PRT} + t_{RTR}$.

5
FIFOS



Switching Waveforms (continued)

Empty Flag and Read Data Flow-Through Mode

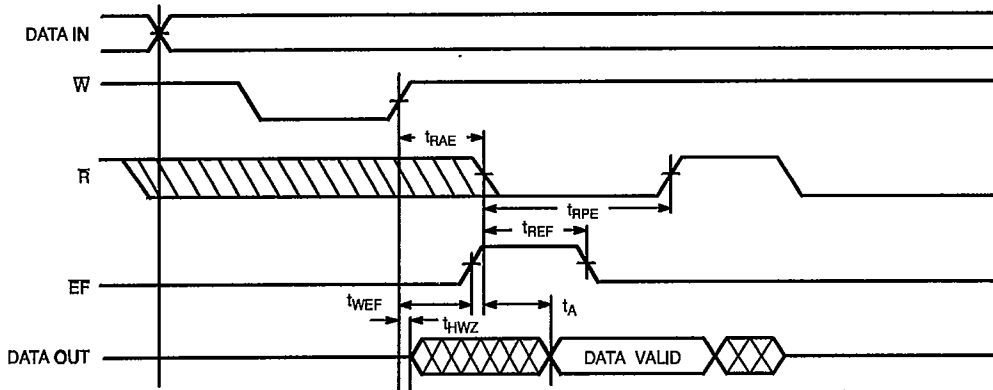

C420-13

Full Flag and Write Data Flow-Through Mode

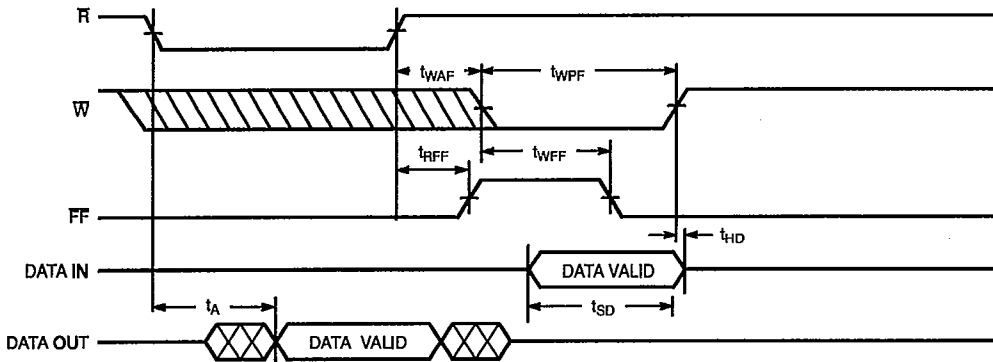

C420-14



Switching Waveforms (continued)

Expansion Timing Diagrams

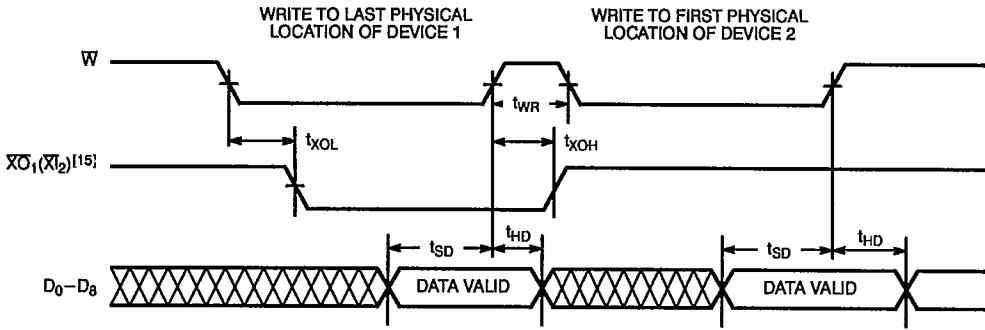

C420-15

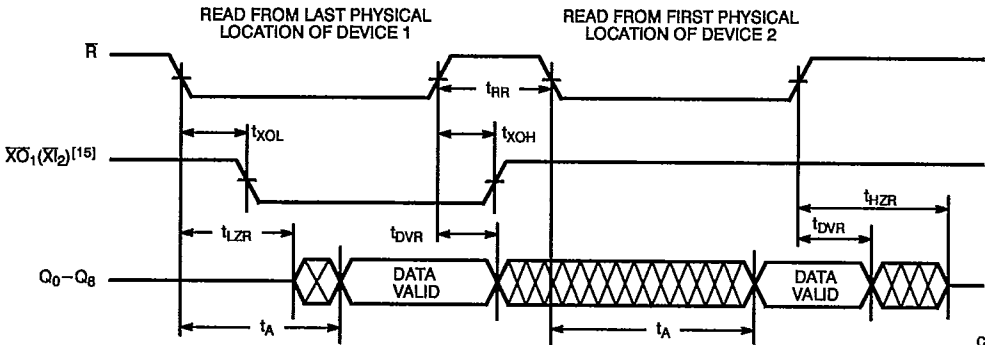

C420-16

Note:
15. Expansion Out of device 1 (XO_1) is connected to Expansion In of device 2 (XI_2).

5
FIFOS



CY7C420, CY7C421, CY7C424
CY7C425, CY7C428, CY7C429

Architecture

The CY7C420/421/424/425/428/429 FIFOs consist of an array of 512/1024/2048 words of 9 bits each (implemented by an array of dual-port RAM cells), a read pointer, a write pointer, control signals (\bar{W} , \bar{R} , \bar{X} , \bar{XO} , \bar{FL} , \bar{RT} , \bar{MR}), and Full, Half Full, and Empty flags.

Dual-Port RAM

The dual-port RAM architecture refers to the basic memory cell used in the RAM. The cell itself enables the read and write operations to be independent of each other, which is necessary to achieve truly asynchronous operation of the inputs and outputs. A second benefit is that the time required to increment the read and write pointers is much less than the time that would be required for data propagation through the memory, which would be the case if the memory were implemented using the conventional register array architecture.

Resetting the FIFO

Upon power-up, the FIFO must be reset with a Master Reset (\bar{MR}) cycle. This causes the FIFO to enter the empty condition signified by the Empty flag (\bar{EF}) being LOW, and both the Half Full (\bar{HF}) and Full flags (\bar{FF}) being HIGH. Read (\bar{R}) and write (\bar{W}) must be HIGH t_{RPW}/t_{WPW} before and t_{RMR} after the rising edge of \bar{MR} for a valid reset cycle. If reading from the FIFO after a reset cycle is attempted, the outputs will all be in the high-impedance state.

Writing Data to the FIFO

The availability of at least one empty location is indicated by a HIGH \bar{FF} . The falling edge of \bar{W} initiates a write cycle. Data appearing at the inputs ($D_0 - D_8$) t_{SD} before and t_{HD} after the rising edge of \bar{W} will be stored sequentially in the FIFO.

The \bar{EF} LOW-to-HIGH transition occurs t_{WEF} after the first LOW-to-HIGH transition of \bar{W} for an empty FIFO. \bar{HF} goes LOW t_{WHF} after the falling edge of \bar{W} following the FIFO actually being Half Full. Therefore, the \bar{HF} is active once the FIFO is filled to half its capacity plus one word. \bar{HF} will remain LOW while less than one half of total memory is available for writing. The LOW-to-HIGH transition of \bar{HF} occurs t_{RHF} after the rising edge of \bar{R} when the FIFO goes from half full +1 to half full. \bar{HF} is available in standalone and width expansion modes. \bar{FF} goes LOW t_{WFF} after the falling edge of \bar{W} , during the cycle in which the last available location is filled. Internal logic prevents overrunning a full FIFO. Writes to a full FIFO are ignored and the write pointer is not incremented. \bar{FF} goes HIGH t_{REF} after a read from a full FIFO.

Reading Data from the FIFO

The falling edge of \bar{R} initiates a read cycle if the \bar{EF} is not LOW. Data outputs ($Q_0 - Q_8$) are in a high-impedance condition between read operations (\bar{R} HIGH) when the FIFO is empty, or when the FIFO is not the active device in the depth expansion mode.

When one word is in the FIFO, the falling edge of \bar{R} initiates a HIGH-to-LOW transition of \bar{EF} . When the FIFO is empty, the outputs are in a high-impedance state. Reads to an empty FIFO are ignored and do not increment the read pointer. From the empty condition, the FIFO can be read t_{WEF} after a valid write.

Retransmit

The retransmit feature is beneficial when transferring packets of data. It enables the receipt of data to be acknowledged by the receiver and retransmitted if necessary.

The Retransmit (\bar{RT}) input is active in the standalone and width expansion modes. The retransmit feature is intended for use when a number of writes equal to or less than the depth of the FIFO have occurred since the last \bar{MR} cycle. A LOW pulse on \bar{RT} resets the internal read pointer to the first physical location of the FIFO. \bar{R} and \bar{W} must both be HIGH while and t_{RTR} after retransmit is LOW. With every read cycle after retransmit, previously accessed data is read and the read pointer is incremented until it is equal to the write pointer. Full, Half Full, and Empty flags are governed by the relative locations of the read and write pointers and are updated during a retransmit cycle. Data written to the FIFO after activation of \bar{RT} are transmitted also.

The full depth of the FIFO can be repeatedly transmitted.

Standalone/Width Expansion Modes

Standalone and width expansion modes are set by grounding Expansion In (\bar{XI}) and tying First Load (\bar{FL}) to V_{CC} . FIFOs can be expanded in width to provide word widths greater than nine in increments of nine. During width expansion mode, all control line inputs are common to all devices, and flag outputs from any device can be monitored.

Depth Expansion Mode (see Figure 1)

Depth expansion mode is entered when, during a \bar{MR} cycle, Expansion Out (\bar{XO}) of one device is connected to Expansion In (\bar{XI}) of the next device, with \bar{XO} of the last device connected to \bar{XI} of the first device. In the depth expansion mode the First Load (\bar{FL}) input, when grounded, indicates that this part is the first to be loaded. All other devices must have this pin HIGH. To enable the correct FIFO, \bar{XO} is pulsed LOW when the last physical location of the previous FIFO is written to and pulsed LOW again when the last physical location is read. Only one FIFO is enabled for read and one for write at any given time. All other devices are in standby.

FIFOs can also be expanded simultaneously in depth and width. Consequently, any depth or width FIFO can be created of word widths in increments of 9. When expanding in depth, a composite \bar{FF} must be created by ORing the \bar{FF} s together. Likewise, a composite \bar{EF} is created by ORing the \bar{EF} s together. \bar{HF} and \bar{RT} functions are not available in depth expansion mode.



CY7C420, CY7C421, CY7C424
CY7C425, CY7C428, CY7C429

Typical DC and AC Characteristics

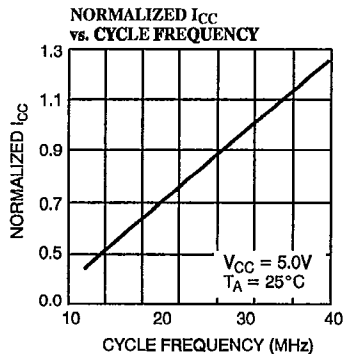
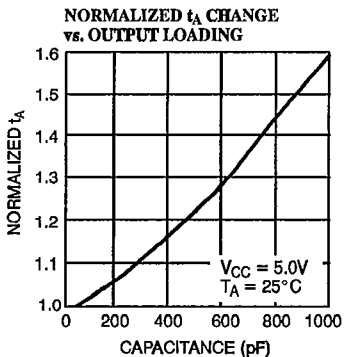
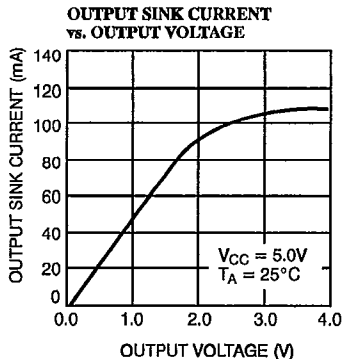
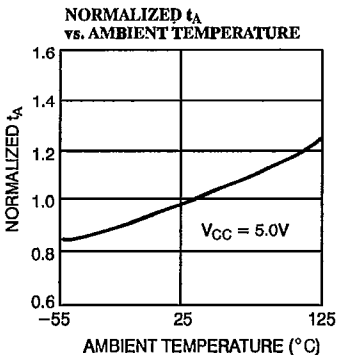
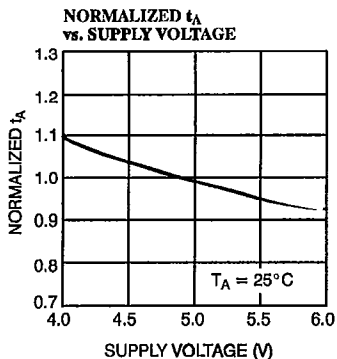
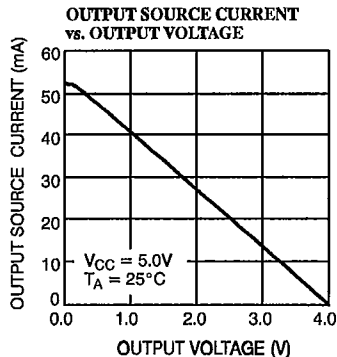
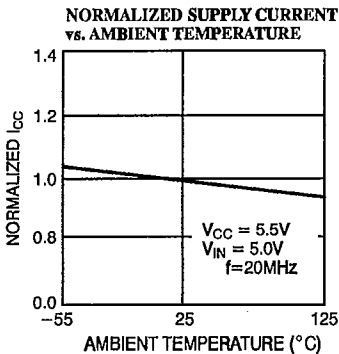
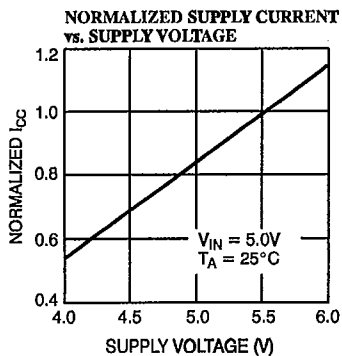



CY7C420, CY7C421, CY7C424
CY7C425, CY7C428, CY7C429

Ordering Information

Speed (ns)	Ordering Code	Package Type	Package Type	Operating Range
20	CY7C420-20DC	D16	28-Lead (600-Mil) CerDIP	Commercial
	CY7C420-20PC	P15	28-Lead (600-Mil) Molded DIP	
25	CY7C420-25DC	D16	28-Lead (600-Mil) CerDIP	Commercial
	CY7C420-25PC	P15	28-Lead (600-Mil) Molded DIP	
	CY7C420-25PI	P15	28-Lead (600-Mil) Molded DIP	Industrial
	CY7C420-25DMB	D16	28-Lead (600-Mil) CerDIP	Military
30	CY7C420-30DC	D16	28-Lead (600-Mil) CerDIP	Commercial
	CY7C420-30PC	P15	28-Lead (600-Mil) Molded DIP	
	CY7C420-30PI	P15	28-Lead (600-Mil) Molded DIP	Industrial
	CY7C420-30DMB	D16	28-Lead (600-Mil) CerDIP	Military
40	CY7C420-40DC	D16	28-Lead (600-Mil) CerDIP	Commercial
	CY7C420-40PC	P15	28-Lead (600-Mil) Molded DIP	
	CY7C420-40PI	P15	28-Lead (600-Mil) Molded DIP	Industry
	CY7C420-40DMB	D16	28-Lead (600-Mil) CerDIP	Military
65	CY7C420-65DC	D16	28-Lead (600-Mil) CerDIP	Commercial
	CY7C420-65PC	P15	28-Lead (600-Mil) Molded DIP	
	CY7C420-65PI	P15	28-Lead (600-Mil) Molded DIP	Industrial
	CY7C420-65DMB	D16	28-Lead (600-Mil) CerDIP	Military

5

FIFOS

CYPRESS
SEMICONDUCTORCY7C420, CY7C421, CY7C424
CY7C425, CY7C428, CY7C429

Ordering Information (continued)

Speed (ns)	Ordering Code	Package Type	Package Type	Operating Range
20	CY7C421-20DC	D22	28-Lead (300-Mil) CerDIP	Commercial
	CY7C421-20JC	J65	32-Lead Plastic Leaded Chip Carrier	
	CY7C421-20PC	P21	28-Lead (300-Mil) Molded DIP	
	CY7C421-20VC	V21	28-Lead (300-Mil) Molded SOJ	
25	CY7C421-25DC	D22	28-Lead (300-Mil) CerDIP	Commercial
	CY7C421-25JC	J65	32-Lead Plastic Leaded Chip Carrier	
	CY7C421-25PC	P21	28-Lead (300-Mil) Molded DIP	
	CY7C421-25VC	V21	28-Lead (300-Mil) Molded SOJ	
	CY7C421-25JI	J65	32-Lead Plastic Leaded Chip Carrier	Industrial
	CY7C421-25PI	P21	28-Lead (300-Mil) Molded DIP	
	CY7C421-25DMB	D22	28-Lead (300-Mil) CerDIP	Military
	CY7C421-25KMB	K74	28-Lead Rectangular Cerpack	
	CY7C421-25LMB	L55	32-Pin Rectangular Leadless Chip Carrier	
30	CY7C421-30DC	D22	28-Lead (300-Mil) CerDIP	Commercial
	CY7C421-30JC	J65	32-Lead Plastic Leaded Chip Carrier	
	CY7C421-30PC	P21	28-Lead (300-Mil) Molded DIP	
	CY7C421-30VC	V21	28-Lead (300-Mil) Molded SOJ	
	CY7C421-30JI	J65	32-Lead Plastic Leaded Chip Carrier	Industrial
	CY7C421-30PI	P21	28-Lead (300-Mil) Molded DIP	
	CY7C421-30DMB	D22	28-Lead (300-Mil) CerDIP	Military
	CY7C421-30KMB	K74	28-Lead Rectangular Cerpack	
CY7C421-30LMB	L55	32-Pin Rectangular Leadless Chip Carrier		
40	CY7C421-40DC	D22	28-Lead (300-Mil) CerDIP	Commercial
	CY7C421-40JC	J65	32-Lead Plastic Leaded Chip Carrier	
	CY7C421-40PC	P21	28-Lead (300-Mil) Molded DIP	
	CY7C421-40VC	V21	28-Lead (300-Mil) Molded SOJ	
	CY7C421-40JI	J65	32-Lead Plastic Leaded Chip Carrier	Industrial
	CY7C421-40PI	P21	28-Lead (300-Mil) Molded DIP	
	CY7C421-40DMB	D22	28-Lead (300-Mil) CerDIP	Military
	CY7C421-40KMB	K74	28-Lead Rectangular Cerpack	
CY7C421-40LMB	L55	32-Pin Rectangular Leadless Chip Carrier		
65	CY7C421-65DC	D22	28-Lead (300-Mil) CerDIP	Commercial
	CY7C421-65JC	J65	32-Lead Plastic Leaded Chip Carrier	
	CY7C421-65PC	P21	28-Lead (300-Mil) Molded DIP	
	CY7C421-65VC	V21	28-Lead (300-Mil) Molded SOJ	
	CY7C421-65JI	J65	32-Lead Plastic Leaded Chip Carrier	Industrial
	CY7C421-65PI	P21	28-Lead (300-Mil) Molded DIP	
	CY7C421-65DMB	D22	28-Lead (300-Mil) CerDIP	Military
	CY7C421-65KMB	K74	28-Lead Rectangular Cerpack	
	CY7C421-65LMB	L55	32-Pin Rectangular Leadless Chip Carrier	



CY7C420, CY7C421, CY7C424
CY7C425, CY7C428, CY7C429

Ordering Information (continued)

Speed (ns)	Ordering Code	Package Type	Package Type	Operating Range
20	CY7C424-20DC	D16	28-Lead (600-Mil) CerDIP	Commercial
	CY7C424-20PC	P15	28-Lead (600-Mil) Molded DIP	
25	CY7C424-25DC	D16	28-Lead (600-Mil) CerDIP	Commercial
	CY7C424-25PC	P15	28-Lead (600-Mil) Molded DIP	
	CY7C424-25PI	P15	28-Lead (600-Mil) Molded DIP	Industrial
	CY7C424-25DMB	D16	28-Lead (600-Mil) CerDIP	Military
30	CY7C424-30DC	D16	28-Lead (600-Mil) CerDIP	Commercial
	CY7C424-30PC	P15	28-Lead (600-Mil) Molded DIP	
	CY7C424-30PI	P15	28-Lead (600-Mil) Molded DIP	Industrial
	CY7C424-30DMB	D16	28-Lead (600-Mil) CerDIP	Military
40	CY7C424-40DC	D16	28-Lead (600-Mil) CerDIP	Commercial
	CY7C424-40PC	P15	28-Lead (600-Mil) Molded DIP	
	CY7C424-40PI	P15	28-Lead (600-Mil) Molded DIP	Industrial
	CY7C424-40DMB	D16	28-Lead (600-Mil) CerDIP	Military
65	CY7C424-65DC	D16	28-Lead (600-Mil) CerDIP	Commercial
	CY7C424-65PC	P15	28-Lead (600-Mil) Molded DIP	
	CY7C424-65PI	P15	28-Lead (600-Mil) Molded DIP	Industrial
	CY7C424-65DMB	D16	28-Lead (600-Mil) CerDIP	Military

CY7C420, CY7C421, CY7C424
CY7C425, CY7C428, CY7C429



CYPRESS
SEMICONDUCTOR

Ordering Information (continued)

Speed (ns)	Ordering Code	Package Type	Package Type	Operating Range
20	CY7C425-20DC	D22	28-Lead (300-Mil) CerDIP	Commercial
	CY7C425-20JC	J65	32-Lead Plastic Leaded Chip Carrier	
	CY7C425-20PC	P21	28-Lead (300-Mil) Molded DIP	
	CY7C425-20VC	V21	28-Lead (300-Mil) Molded SOJ	
25	CY7C425-25DC	D22	28-Lead (300-Mil) CerDIP	Commercial
	CY7C425-25JC	J65	32-Lead Plastic Leaded Chip Carrier	
	CY7C425-25PC	P21	28-Lead (300-Mil) Molded DIP	
	CY7C425-25VC	V21	28-Lead (300-Mil) Molded SOJ	
	CY7C425-25JI	J65	32-Lead Plastic Leaded Chip Carrier	Industrial
	CY7C425-25PI	P21	28-Lead (300-Mil) Molded DIP	
	CY7C425-25DMB	D22	28-Lead (300-Mil) CerDIP	Military
	CY7C425-25KMB	K74	28-Lead Rectangular Cerpack	
CY7C425-25LMB	L55	32-Pin Rectangular Leadless Chip Carrier		
30	CY7C425-30DC	D22	28-Lead (300-Mil) CerDIP	Commercial
	CY7C425-30JC	J65	32-Lead Plastic Leaded Chip Carrier	
	CY7C425-30PC	P21	28-Lead (300-Mil) Molded DIP	
	CY7C425-30VC	V21	28-Lead (300-Mil) Molded SOJ	
	CY7C425-30JI	J65	32-Lead Plastic Leaded Chip Carrier	Industrial
	CY7C425-30PI	P21	28-Lead (300-Mil) Molded DIP	
	CY7C425-30DMB	D22	28-Lead (300-Mil) CerDIP	Military
	CY7C425-30KMB	K74	28-Lead Rectangular Cerpack	
CY7C425-30LMB	L55	32-Pin Rectangular Leadless Chip Carrier		
40	CY7C425-40DC	D22	28-Lead (300-Mil) CerDIP	Commercial
	CY7C425-40JC	J65	32-Lead Plastic Leaded Chip Carrier	
	CY7C425-40PC	P21	28-Lead (300-Mil) Molded DIP	
	CY7C425-40VC	V21	28-Lead (300-Mil) Molded SOJ	
	CY7C425-40JI	J65	32-Lead Plastic Leaded Chip Carrier	Industrial
	CY7C425-40PI	P21	28-Lead (300-Mil) Molded DIP	
	CY7C425-40DMB	D22	28-Lead (300-Mil) CerDIP	Military
	CY7C425-40KMB	K74	28-Lead Rectangular Cerpack	
CY7C425-40LMB	L55	32-Pin Rectangular Leadless Chip Carrier		
65	CY7C425-65DC	D22	28-Lead (300-Mil) CerDIP	Commercial
	CY7C425-65JC	J65	32-Lead Plastic Leaded Chip Carrier	
	CY7C425-65PC	P21	28-Lead (300-Mil) Molded DIP	
	CY7C425-65VC	V21	28-Lead (300-Mil) Molded SOJ	
	CY7C425-65JI	J65	32-Lead Plastic Leaded Chip Carrier	Industrial
	CY7C425-65PI	P21	28-Lead (300-Mil) Molded DIP	
	CY7C425-65DMB	D22	28-Lead (300-Mil) CerDIP	Military
	CY7C425-65KMB	K74	28-Lead Rectangular Cerpack	
CY7C425-65LMB	L55	32-Pin Rectangular Leadless Chip Carrier		

CYPRESS
SEMICONDUCTOR
CY7C420, CY7C421, CY7C424
CY7C425, CY7C428, CY7C429
Ordering Information (continued)

Speed (ns)	Ordering Code	Package Type	Package Type	Operating Range
20	CY7C428-20DC	D16	28-Lead (600-Mil) CerDIP	Commercial
	CY7C428-20PC	P15	28-Lead (600-Mil) Molded DIP	
25	CY7C428-25DC	D16	28-Lead (600-Mil) CerDIP	Commercial
	CY7C428-25PC	P15	28-Lead (600-Mil) Molded DIP	Industrial
	CY7C428-25PI	P15	28-Lead (600-Mil) Molded DIP	
	CY7C428-25DMB	D16	28-Lead (600-Mil) CerDIP	
30	CY7C428-30DC	D16	28-Lead (600-Mil) CerDIP	Commercial
	CY7C428-30PC	P15	28-Lead (600-Mil) Molded DIP	Industrial
	CY7C428-30PI	P15	28-Lead (600-Mil) Molded DIP	
	CY7C428-30DMB	D16	28-Lead (600-Mil) CerDIP	
40	CY7C428-40DC	D16	28-Lead (600-Mil) CerDIP	Commercial
	CY7C428-40PC	P15	28-Lead (600-Mil) Molded DIP	Industrial
	CY7C428-40PI	P15	28-Lead (600-Mil) Molded DIP	
	CY7C428-40DMB	D16	28-Lead (600-Mil) CerDIP	
65	CY7C428-65DC	D16	28-Lead (600-Mil) CerDIP	Commercial
	CY7C428-65PC	P15	28-Lead (600-Mil) Molded DIP	Industrial
	CY7C428-65PI	P15	28-Lead (600-Mil) Molded DIP	
	CY7C428-65DMB	D16	28-Lead (600-Mil) CerDIP	

5

FIFos



**CY7C420, CY7C421, CY7C424
CY7C425, CY7C428, CY7C429**

Ordering Information (continued)

Speed (ns)	Ordering Code	Package Type	Package Type	Operating Range
20	CY7C429-20DC	D22	28-Lead (300-Mil) CerDIP	Commercial
	CY7C429-20JC	J65	32-Lead Plastic Leaded Chip Carrier	
	CY7C429-20PC	P21	28-Lead (300-Mil) Molded DIP	
	CY7C429-20VC	V21	28-Lead (300-Mil) Molded SOJ	
25	CY7C429-25DC	D22	28-Lead (300-Mil) CerDIP	Commercial
	CY7C429-25JC	J65	32-Lead Plastic Leaded Chip Carrier	
	CY7C429-25PC	P21	28-Lead (300-Mil) Molded DIP	
	CY7C429-25VC	V21	28-Lead (300-Mil) Molded SOJ	Industrial
	CY7C429-25JI	J65	32-Lead Plastic Leaded Chip Carrier	
	CY7C429-25PI	P21	28-Lead (300-Mil) Molded DIP	
	CY7C429-25DMB	D22	28-Lead (300-Mil) CerDIP	Military
	CY7C429-25KMB	K74	28-Lead Rectangular Cerpack	
	CY7C429-25LMB	L55	32-Pin Rectangular Leadless Chip Carrier	
30	CY7C429-30DC	D22	28-Lead (300-Mil) CerDIP	Commercial
	CY7C429-30JC	J65	32-Lead Plastic Leaded Chip Carrier	
	CY7C429-30PC	P21	28-Lead (300-Mil) Molded DIP	
	CY7C429-30VC	V21	28-Lead (300-Mil) Molded SOJ	Industrial
	CY7C429-30JI	J65	32-Lead Plastic Leaded Chip Carrier	
	CY7C429-30PI	P21	28-Lead (300-Mil) Molded DIP	
	CY7C429-30DMB	D22	28-Lead (300-Mil) CerDIP	Military
	CY7C429-30KMB	K74	28-Lead Rectangular Cerpack	
	CY7C429-30LMB	L55	32-Pin Rectangular Leadless Chip Carrier	
40	CY7C429-40DC	D22	28-Lead (300-Mil) CerDIP	Commercial
	CY7C429-40JC	J65	32-Lead Plastic Leaded Chip Carrier	
	CY7C429-40PC	P21	28-Lead (300-Mil) Molded DIP	
	CY7C429-40VC	V21	28-Lead (300-Mil) Molded SOJ	Industrial
	CY7C429-40JI	J65	32-Lead Plastic Leaded Chip Carrier	
	CY7C429-40PI	P21	28-Lead (300-Mil) Molded DIP	
	CY7C429-40DMB	D22	28-Lead (300-Mil) CerDIP	Military
	CY7C429-40KMB	K74	28-Lead Rectangular Cerpack	
	CY7C429-40LMB	L55	32-Pin Rectangular Leadless Chip Carrier	
65	CY7C429-65DC	D22	28-Lead (300-Mil) CerDIP	Commercial
	CY7C429-65JC	J65	32-Lead Plastic Leaded Chip Carrier	
	CY7C429-65PC	P21	28-Lead (300-Mil) Molded DIP	
	CY7C429-65VC	V21	28-Lead (300-Mil) Molded SOJ	Industrial
	CY7C429-65JI	J65	32-Lead Plastic Leaded Chip Carrier	
	CY7C429-65PI	P21	28-Lead (300-Mil) Molded DIP	
	CY7C429-65DMB	D22	28-Lead (300-Mil) CerDIP	Military
	CY7C429-65KMB	K74	28-Lead Rectangular Cerpack	
	CY7C429-65LMB	L55	32-Pin Rectangular Leadless Chip Carrier	



CY7C420, CY7C421, CY7C424
CY7C425, CY7C428, CY7C429

MILITARY SPECIFICATIONS
Group A Subgroup Testing
DC Characteristics

Parameters	Subgroups
V _{OH}	1, 2, 3
V _{OL}	1, 2, 3
V _{IH}	1, 2, 3
V _{IL Max.}	1, 2, 3
I _{Ix}	1, 2, 3
I _{CC}	1, 2, 3
I _{SB1}	1, 2, 3
I _{SB2}	1, 2, 3
I _{OS}	1, 2, 3

Switching Characteristics

Parameters	Subgroups
t _{RC}	9, 10, 11
t _A	9, 10, 11
t _{RR}	9, 10, 11
t _{PR}	9, 10, 11
t _{LZR}	9, 10, 11
t _{DVR}	9, 10, 11
t _{HZR}	9, 10, 11
t _{WC}	9, 10, 11
t _{PW}	9, 10, 11
t _{HWZ}	9, 10, 11
t _{WR}	9, 10, 11
t _{SD}	9, 10, 11
t _{HD}	9, 10, 11
t _{MRSC}	9, 10, 11
t _{PMR}	9, 10, 11
t _{RMR}	9, 10, 11
t _{RPW}	9, 10, 11
t _{WPW}	9, 10, 11
t _{RTC}	9, 10, 11
t _{PRT}	9, 10, 11
t _{TR}	9, 10, 11
t _{EFL}	9, 10, 11
t _{HFH}	9, 10, 11
t _{FFH}	9, 10, 11
t _{REF}	9, 10, 11
t _{RFF}	9, 10, 11
t _{WEF}	9, 10, 11
t _{WFF}	9, 10, 11
t _{WHF}	9, 10, 11
t _{RHF}	9, 10, 11
t _{RAE}	9, 10, 11
t _{RPE}	9, 10, 11
t _{WAF}	9, 10, 11
t _{WPF}	9, 10, 11
t _{XOL}	9, 10, 11
t _{XOH}	9, 10, 11

Document #: 38-00079-1